

2024



HYDROFLOW

Irrigation Catalogue

Contents

Hydroflow

05	Hydroflow Introduction
06	Our Sales Team
07	Our Brands
08	Partnership with Rain Bird
09	Rain Bird Solutions
10	Basic Components
12	Landscape Problems, Hydroflow Solutions

Irrigation Range

14	Sprinklers - Spray Heads
22	Sprinklers - Rotors
28	Impact Sprinklers
32	Sprinkler Accessories
36	Control Valves
42	Control Valve Accessories
46	Quick Coupling Valves
48	Valve Boxes
50	Controllers
68	Cable and Cable Accessories
72	Drip / Micro Irrigation

Irrigation Design

78	Why choose our products?
80	Scale Plan / Drawing
82	Water Supply

Product Guides

84	HE-VAN / R-VAN / VAN Nozzle Performance
88	3500 / 5000 Rotor Pop-Up Nozzle Performance
90	Controllers / Dripline
91	Valves / Rain Shutoff Devices
92	Installation Tips

Contact

93	Auckland / Christchurch
----	-------------------------

WATER FOR LIFE • CARE FOR QUALITY

Hydroflow,
seeking a new
standard for
water, for life.



Hydroflow is one of New Zealand's leading sources of solutions for the full lifecycle of water.

Our focus is on water and sourcing the world's most innovative products for its safe control, quality and conservation.

We offer tailored solutions that solve our customers' problems by understanding and responding to new regulations and conditions.

Hydroflow supply world leading brands to six key market segments; Plumbing, Rural, Irrigation, Fire, HVAC and Civil Infrastructure.

Empowering through Knowledge

At Hydroflow, we are driven by our commitment to 'Leading with Knowledge.' This core principle is ingrained in everything we do, allowing us to provide specialist technical support and literature, industry expertise, and innovative products. We believe that knowledge is power, and we strive to empower our customers through information and innovation.

Proud Partnership with Rain Bird

Hydroflow are proud to distribute Rain Bird, an established global brand renowned for their unwavering commitment to quality and innovation in the irrigation industry. With their extensive range of products, we provide our customers the assurance of quality irrigation solutions that meet the highest standards.

Irrigation Design Services

Specialising in providing effective irrigation design services, Hydroflow is dedicated to staying at the forefront of industry innovation and ensuring that our customers receive only the highest quality products and service. Our team of experts are committed to delivering unrivaled solutions tailored to meet your unique needs. From expert advice to creating detailed CAD plans with specifications and materials schedules, we have you covered.

See the end of this catalogue for contact details and a do it yourself guide if you want to design the system yourself.

Our Sales Team

➤ Region 1

- Northland
- Auckland

➤ Region 2

- Waikato/King Country
- Bay Of Plenty
- Manawatu/Taranaki
- East Coast/Wellington/Hawkes Bay

➤ Region 3

- West Coast/Nelson/Marlborough
- Christchurch/North Canterbury
- South Canterbury/North Otago
- Otago/Southland/Central Otago

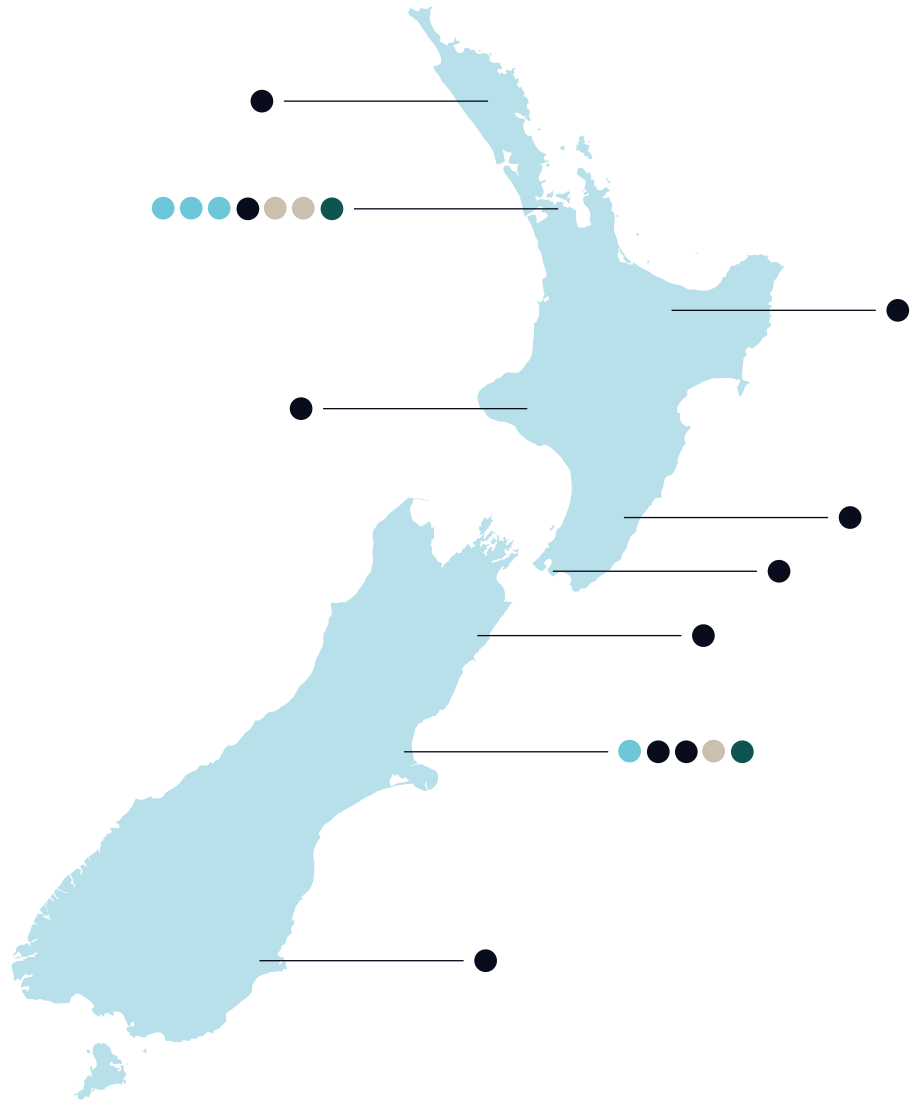

● Customer Service Reps

Providing support and assistance via phone and email to our current and prospective customer base.

● Technical Specialists

Supporting our customer base through technical expertise.

● Territory Managers

Serving as the main connection between the customer and HQ through relationship building.

● Irrigation Specialists

Water design specialists that also provide expert technical advice.

Our Brands



Install a Rheem®





Hydroflow is proud to Partner with Rain Bird

Putting Water Efficiency to Work for You

For over 90 years, Rain Bird has been dedicated to using water responsibly. We call it The Intelligent Use of Water™ and it's the thinking behind our full suite of water-saving tools, training, services and products. Because of these solutions, Rain Bird is better positioned than any other irrigation manufacturer to help you efficiently source, design, schedule, apply and maintain the world's most precious resource.

Good for our environment. Even better for your bottom line.

The landscape irrigation industry is changing. More restrictions are placed on water use every year. Irrigation professionals have two options: adapt and prosper...or be left behind. As the industry leader in water-efficient irrigation, Rain Bird can help your business thrive.

The Intelligent Use of Water™

▶ Don't allow your business to be left behind. Visit www.hydroflow.co.nz or contact your Hydroflow sales representative.

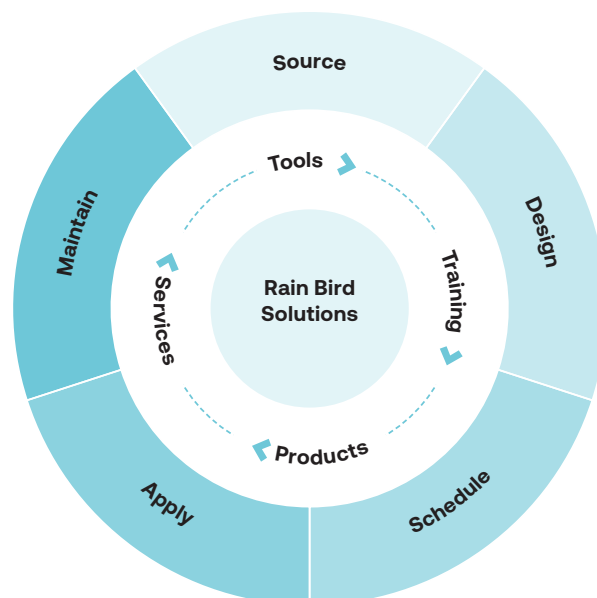

Rain Bird Solutions:

Source

Tap into underutilised supplies such as underground well water, grey water, black water, HVAC condensate and rainwater.

Non-potable-water-ready:

- Valves
- Rotors
- Sprays
- Drip products

Design

Create landscapes as sustainable as they are beautiful.

- Design support and resources, including a referral network of top irrigation consultants and landscape architects in your area

- Comprehensive training
- CAD drawings

Schedule

Optimise the timing, quantity and frequency of water applied to the landscape with leading-edge water management controls.

Automatic controllers with water-efficient features:

- ESP-Modular
- RC2 Controller
- ESP-LX Modular

Smart technologies:

- ET Manager products
- SMRT-Y Soil Moisture Sensor

Automatic shut-off devices:

- RSD Rain Sensor
- WR2 Wireless Rain and Rain/Freeze Sensors

Central Control systems:

- Automatic ET-based scheduling
- Flow management
- Flow monitoring/leak detection
- Cycle + Soak

Apply

Distribute water to the landscape as efficiently as possible.

Water-smart rotor and spray features:

- Pressure Regulating Stem (PRS) technology
- Seal-A-Matic™ (SAM) check valves
- Root Watering Series

High-efficiency nozzles:

- Rain Curtain™ Nozzles
- U-Series Nozzles
- Matched Precipitation Rate (MPR) Nozzles
- SQ Square Pattern Nozzles (formerly XPCN)
- Rotary Nozzles

Maintain

Maintain every aspect of the system to ensure efficient and affordable water use for the long haul.

- Durable products with worry-free warranties and built-in expandability
- Phone support and on-site service through certified service providers

- The Global Service Plan (GSP) for central control systems
- Comprehensive training

* Not all of these services are offered by Rain Bird Corporation but we can help you locate quality providers of these services.

Basic Components of an Automatic Sprinkler System

A sprinkler system includes three basic components that deliver water to your lawn and garden. Each component has a specific function and is designed for your landscape's diverse watering needs.

1. Controller This is the brain of the system. The controller automatically opens and closes valves according to a preset schedule. Our controllers have easy-to-set programs to help you efficiently manage seasonal adjustments. They also have sensors that signal the controller to shut off the system when it rains.

2. Valves A valve is like a faucet. Valves respond to commands from the controller. When valves receive a signal to open, water flows to the sprinklers. When they receive another signal to close, the flow of water stops.

3. Sprinklers The sprinklers distribute water. We offer a complete line of sprinklers designed to be efficient, durable and reliable. Listed below are four categories of sprinklers or water emission devices.

Automatic sprinkler system Diagram

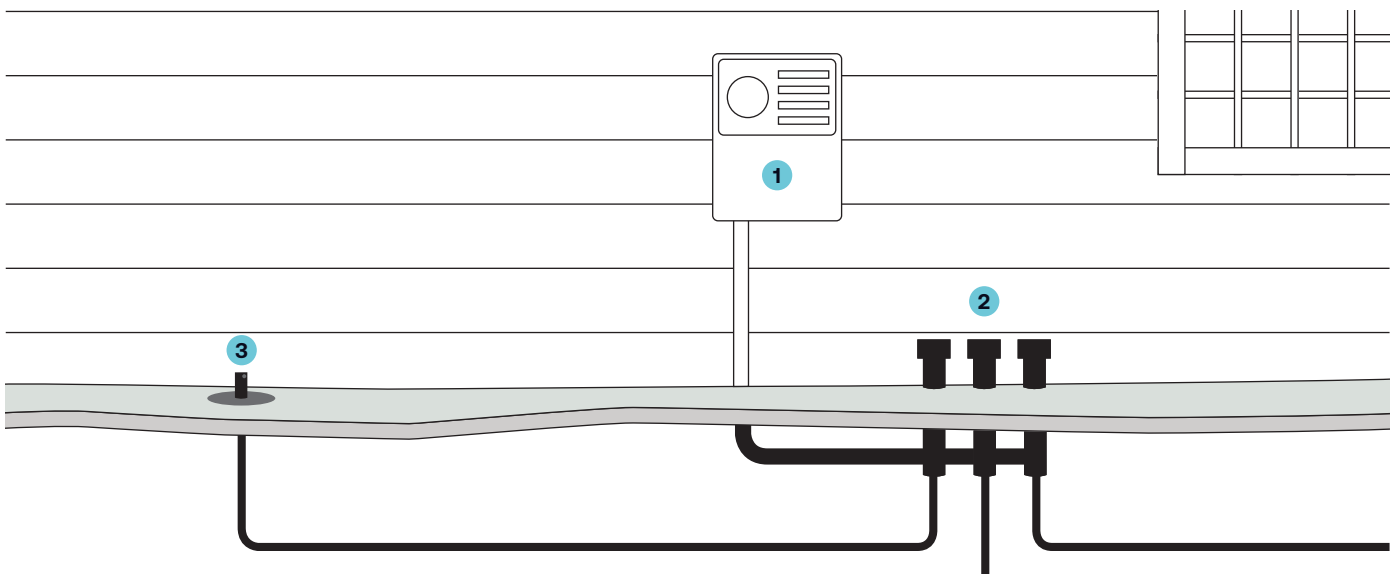

Sprays are installed in small to medium size lawn areas, around curbs and sidewalks, or around flowerbeds and shrubs.



Drip Irrigation, low-volume drip is used to efficiently water individual trees, flowerbeds, potted containers or other non-grass areas. Drip irrigation delivers water directly to the root zone, which helps plants thrive and reduces water loss due to evaporation.



Rotors provide precise, even coverage for larger landscape areas. Our rotors are expertly designed to be reliable and water-efficient.



Rotary Nozzles fit on spray heads but they work like rotors. They deliver water at a lower precipitation rate than a spray, which make them ideal for slopes or areas where erosion is a consideration.

How it Works

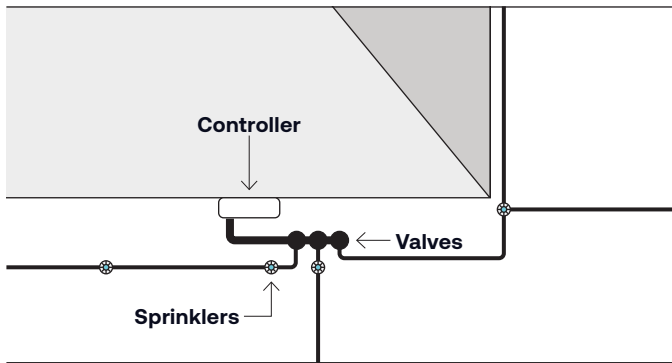

These basic automatic sprinkler system components efficiently and reliably work together, so you can relax and start enjoying your landscape.

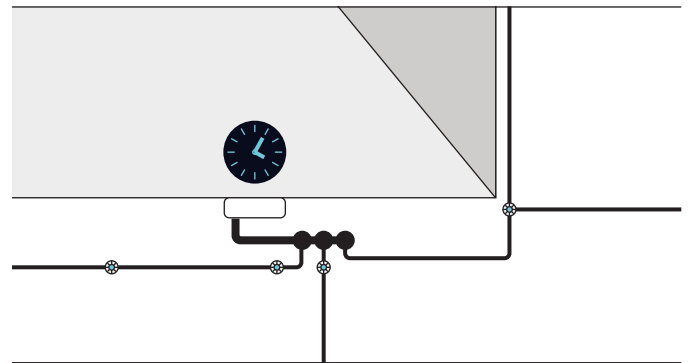

The controller stores the watering schedule.

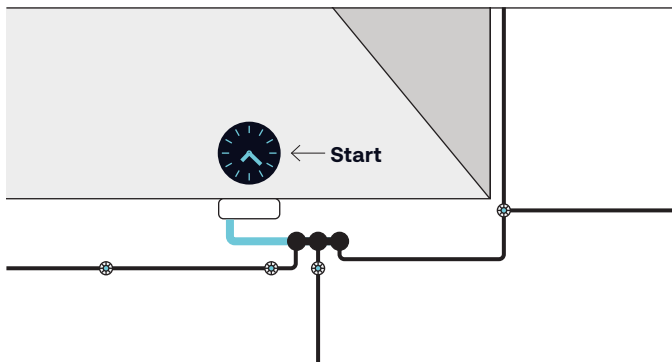

When the controller reaches a scheduled start time, a signal is sent to open one of the valves.

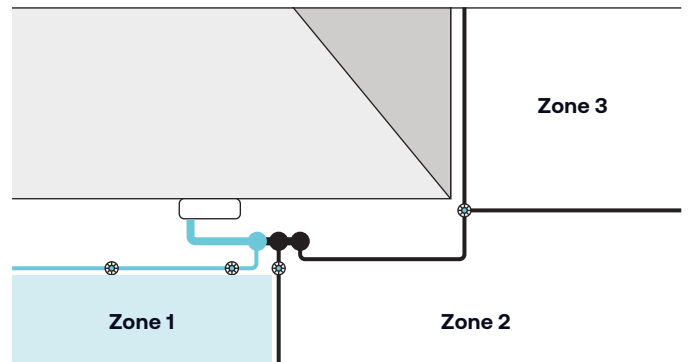

Each valve controls a group of sprinklers. Each group is called a zone or station. When the valve receives the controller's signal to open, water flows to the sprinklers installed in that zone.

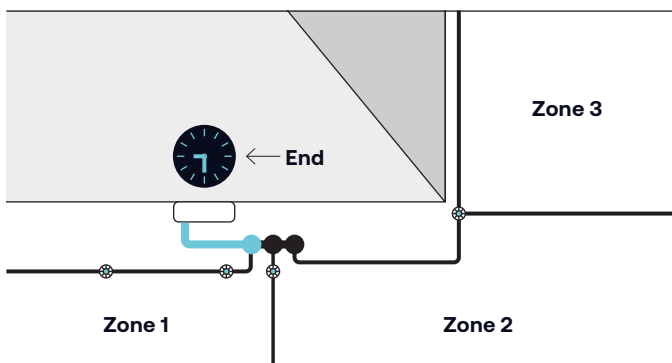

At the end of the scheduled watering time, the controller signals the valve to close, which shuts off the water flowing to the sprinklers.

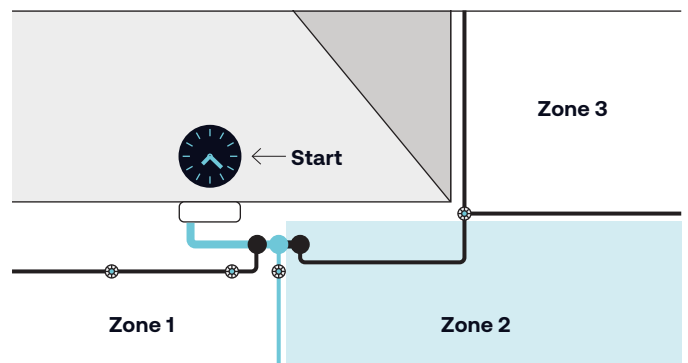

This process is repeated according to the watering schedule stored in the controller.

Landscape Problems. Hydroflow Solutions.

No two landscapes are alike. That's why we offer a diverse, durable and precise irrigation components. Whatever landscape problems you might have, be worry-free knowing Hydroflow has an efficient, hassle-free solution.

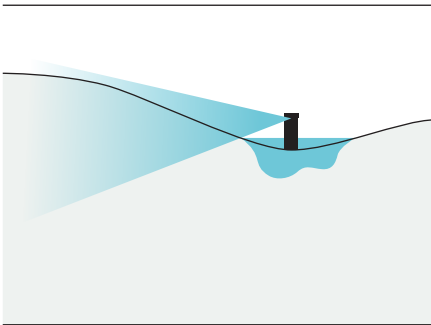

Problem:

Slopes or Hills

Water can puddle or pool around sprinklers installed at the bottom of slopes or hills, causing soggy areas, which can kill grass or encourage fungus to grow.

Our Solutions:

- Rain Bird 1800® Sprays, 3500 Rotors and 5000 Rotors with a Seal-A-Matic™ (SAM) Check Valve alleviate the problem and eliminate puddling.
- Rain Bird Rotary Nozzles deliver water at a lower rate; this allows sufficient soak-in time to prevent run-off.

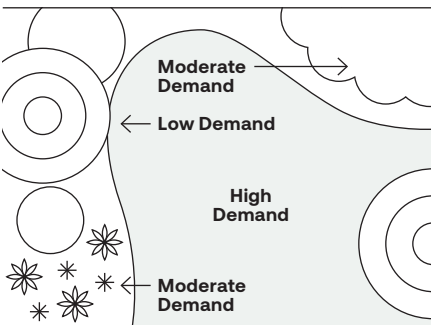

Problem:

Different Plant Types

Shrubs, trees, flowers and grass all need different amounts of water. Delivering the same amount of water to every plant can cause the loss of plant life or you may simply be wasting water on plants that don't need that much.

Our Solutions:

- Low-volume drip allows you to customize your water delivery to each plant's individual watering needs.

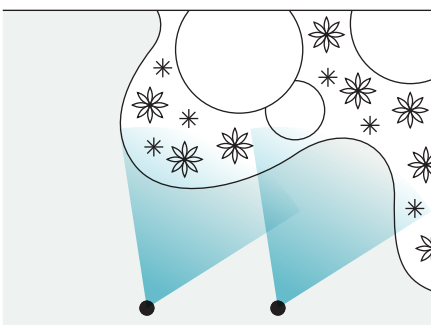

Problem:

Corners, Odd Shapes or Strips

Often it is hard to get complete and adequate coverage in these hard to reach areas, leaving some areas over-watered and others under-watered.

Our Solutions:

- Rain Bird Sprays installed with Variable Arc Nozzles (VAN) efficiently deliver precise, even coverage in any corner or odd-shaped area of the landscape.

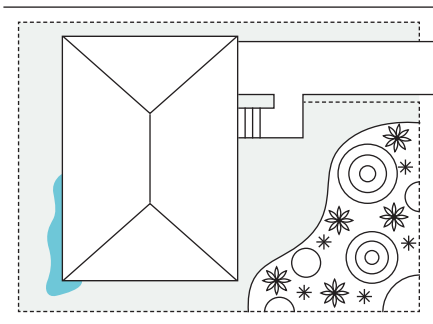

Problem:

Smaller Yard

Smaller areas can be difficult to water, often sprinklers end up watering sidewalks, driveways or spraying against the house or garage.

Our Solutions:

- Low-volume Rain Bird SQ Nozzles precisely water in a square pattern, which results in superior distribution control and uniformity to eliminate over-watering and wasteful run-off.
- Rain Bird Sprays installed with Variable Arc Nozzles (VAN) efficiently deliver precise, even coverage in smaller yards, any corner or odd-shaped area, or smaller strips of lawn.

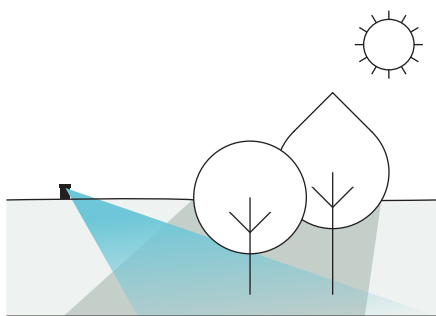

Problem:

Variations in Exposure to the Sun

Over or under-watering often results because not every part of your yard and garden requires the same amount of moisture due to exposure to the sun.

Our Solutions:

- Easy-to-set controllers with multiple, independent programs, like the Rain Bird ESP-Modular, allow additional watering times to be programmed for areas with more sun exposure.
- Low-volume drip allows the customization of precise water delivery to individual plants or groups of plants, based on specific watering needs and exposure to the sun.

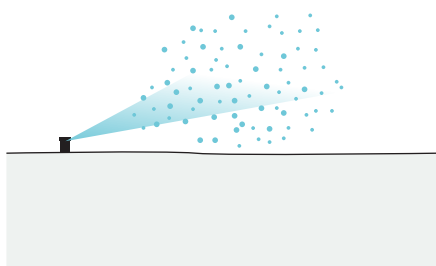

Problem:

Water Pressure

High or fluctuating pressure can cause sprinklers to mist or fog, in this case water is not delivered to your lawn and garden at the optimal rate. A low water-pressure situation can inhibit the sprinklers performance, leading to areas that do not get the proper water coverage.

Our Solutions:

- High pressure can be efficiently controlled at the valve using a PRS Dial.
- At the point of distribution the problem can be controlled using 1800® Sprays and 5000 Plus Rotors with a Pressure Regulating Stem (PRS).
- For low-volume drip systems, install DV Valves with a pressure regulator.
- In areas of the landscape where the pressure has dropped, install Rotary Nozzles.

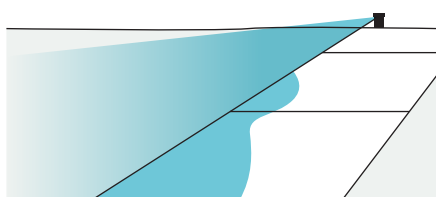

Problem:

Compacted Soil

Certain areas of your lawn might have compacted soil, this condition can cause water to run-off onto sidewalks or driveways without giving it enough time to seep into the soil.

Our Solutions:

- Choose an easy-to-set controller with multiple programs and start times, or choose a controller with the Cycle + Soak option that allows the programming of multiple start times for shorter, precise periods of watering to eliminate run-off.
- Rain Bird Rotary Nozzles deliver water at a lower rate; this allows sufficient soak-in time to prevent run-off.
- Low-volume drip applies water at a slower rate allowing the moisture to penetrate into the soil to prevent run-off.

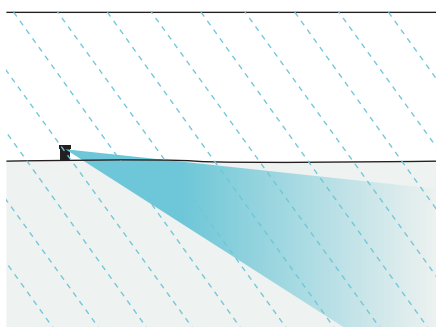

Problem:

Sprinklers Turn On During Rainy Weather

Your system's watering schedule starts when it is already raining.

Our Solutions:

- A Rain Sensor automatically monitors weather conditions and efficiently signals
- the controller to turn the system off when it rains, saving water and saving you money.



Sprinklers - Spray Heads



UNI-SPRAY Series Pop-Up Spray Body - 1/2" Inlet

Compact and reliable 100mm spray head for any application.

- Accepts all Rain Bird nozzles.
- Three year trade warranty.

Description
UniSpray 100mm Body Only (P40000)
UniSpray 100mm with 12 VAN Nozzle (P4101201)
UniSpray 100mm with 15 VAN Nozzle (P4101501)



Inventory Code	Carton QTY	Min Order QTY
US400	50	50
*US412	50	50
*US415	50	50

Rain Bird 1800 Series Pop-Up Spray Body (less Nozzles)

The #1 irrigation spray head in the world.

- Co-molded wiper seal provides unmatched resistance to grit, pressure and the environment.
- Constructed of time-proven UV-resistant plastic and corrosion resistant stainless steel parts, ensuring long product life.
- Precision controlled flush at pop-down clears debris from unit, assuring positive stem retraction in all soil types.
- Two-piece ratchet mechanism allows easy nozzle pattern alignment and provides added durability.
- Accepts all Rain Bird nozzles.
- Five year trade warranty.

Description
1802 Spray Less Nozzle (A44020)
1803 Spray Less Nozzle (N91610)
1804 SprayBody Less Nozzle (A44120)
1804 SprayBody Less Nozzle with SAM (A43905)
1804 SprayBody Less Nozzle with SAM, PRS 30psi (A44915)
1804 SprayBody Less Nozzle with SAM, PRS 45psi (A44916)
1806 SprayBody Less Nozzle (A44205)
1806 SprayBody Less Nozzle with SAM (A43912)
1806 Spray Less Nozzle with SAM, PRS 30psi (A43715)
1812 SprayBody Less Nozzle with Side Inlet (A44305)
1812 SprayBody Less Nozzle with SAM (A43930)
1812 Spray Less Nozzle with SAM, PRS 30psi (A43815)
1812 Spray Less Nozzle with SAM, PRS 45psi (A43816)
1800 Non Potable Snap-on Cover (A46610)



Inventory Code	Carton QTY	Min Order QTY
1802RB	100	1
*1803RB	36	36
1804RB	75	1
1804SAM	75	1
1804SAMP30	75	1
1804SAMP45	75	1
1806RB	50	1
1806SAM	50	1
1806SAMP30	50	1
1812RB	50	1
1812SAM	50	1
1812SAMP30	50	1
1812SAMP45	50	1
1800NP	300	1

*indent only

RD1800 Series Pop-Up Spray Body (Less Nozzle) - 1/2" Inlet

Robust design for harsh applications.

- Patented, triple-blade wiper seal precisely balances flushing, flow-by and debris protection to optimise performance and durability at pop-up and retraction. Precision-controlled flushing at pop-up and retraction clears debris, ensuring positive stem retraction in all soil types.
- Unique debris pockets hold grit in place, removing it from circulation and preventing long-term damage. Parts resistant to corrosion in treated recycled water containing chlorine.
- RD1800™ SAM PRS Series: Incorporates all RD1800 Series SAM and PRS features. Meets the needs of all spray areas, regardless of changing elevation or water pressures.
- RD1800™ SAM P45 Series: Incorporates all RD1800 Series SAM and P45 features. Ensures maximum spray body and nozzle performance even with varying inlet pressures. Recommended for use with rotary nozzles (R-VAN).
- Five year trade warranty.



Description
RD1804 Spray Less Nozzle - NP (A35040NP)
RD1804 SprayBody Less Nozzle with SAM, PRS 30psi (A37340)
RD1804 SprayBody Less Nozzle with SAM, PRS 30psi + Flow Shield (A37340)
RD1804 Spray Less Nozzle with SAM, PRS 30psi + Flow Shield - NP (A37341NP)
RD1804 SprayBody Less Nozzle with SAM, PRS 45psi + Flow Shield (A37441)
RD1804 Spray Less Nozzle with SAM, PRS 45psi + Flow Shield - NP (A37441NP)
RD1806 SprayBody Less Nozzle with SAM, PRS 30psi (A37360)
RD1806 SprayBody Less Nozzle with SAM, PRS 30psi + Flow Shield (A37361)
RD1806 Spray Less Nozzle with SAM, PRS 30psi + Flow Shield - NP (A37361NP)
RD1806 SprayBody Less Nozzle with SAM, PRS 45psi + Flow Shield (A37461)
RD1806 Spray Less Nozzle with SAM, PRS 45psi + Flow Shield - NP (A37461NP)
RD1812 SprayBody Less Nozzle with SAM, PRS 30psi + Flow Shield (A37321)
RD1812 Spray Less Nozzle with SAM, PRS 30psi + Flow Shield - NP (A37321NP)
RD1812 SprayBody Less Nozzle with SAM, PRS 45psi + Flow Shield (A37421)
RD1812 Spray Less Nozzle with SAM, PRS 45psi + Flow Shield - NP (A37421NP)

Inventory Code	Carton QTY	Min Order QTY
*RD04NP	75	75
*RD04SP30	75	75
RD04SP30F	75	
*RD04SP30FN	75	75
*RD04SP45F	75	75
*RD04SP45FN	75	75
*RD06SP30	50	50
*RD06SP30F	50	50
*RD06SP30FN	50	50
*RD06SP45F	50	50
*RD06SP45FN	50	50
*RD12SP30F	50	50
*RD12SP30FN	50	50
*RD12SP45F	50	50
*RD12SP45FN	50	50

Spray Body Accessories

- PA8S & PA8SNP - Plastic Shrub Adaptors. Adapts Rain Bird Nozzles for use with 1/2" (15/21) NPT threaded risers.
- 1800EXT - Plastic Extension. Fits all Rain Bird Spray Bodies and Nozzles. Exception: Cannot be used with bubblers.
- RBA44400 - Plastic Adaptor. Adapts Rain Bird Spray Bodies for use with any 1/2" (15/21) NPT bubbler or spray nozzle.

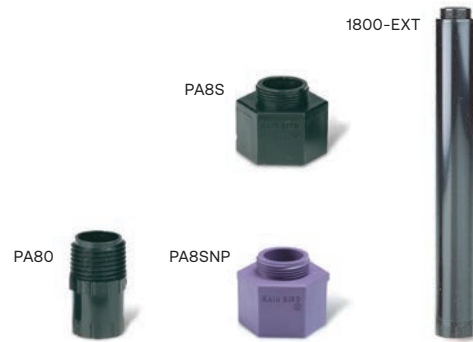

Description
1800 Series 6" Stem Extension (A44500)
1800 Series Shrub Head Adaptor (A16501A)
1800 Series Shrub Head Adaptor - Non Potable (A16505)
PA80 15mm Male Bubbler Adapter 1800s (A44400)

Inventory Code	Carton QTY	Min Order QTY
1800EXT	25	
PA8S	25	25
PA8SNP	25	25
RBA44400	250	

Bubbler Heads

Pressure Compensating Full-Circle Bubblers.

- Low flow rates allow water to be absorbed as needed. Reduces runoff.
- Flow will not fluctuate at pressures between 1.4 to 6.2 bar.
- Flow is not adjustable for increased vandal resistance.
- Shipped with special SR-050 1/2" (15/21) bubbler filter screen for easy installation and resistance to debris.
- Trickle pattern on models 1401 and 1402; umbrella pattern only available on 1404 model.
- Five year trade warranty.



Description
Pressure Compensating Bubbler with Screen 0.95 L/Min (A16110)
Pressure Compensating Bubbler with Screen 1.9 L/Min (A16120)
Pressure Compensating Bubbler with Screen 3.78 L/Min (A16130)

Inventory Code	Carton QTY	Min Order QTY
*1401RB	25	25
*1402RB	25	25
*1404RB	25	25

MPR Nozzles - Fixed Arc Matched Precipitation Rate Nozzles

- Matched precipitation rates across sets and patterns in 5 Series, 8 Series, 10 Series, 12 Series, and 15 Series for even water distribution and design flexibility.
- MPR Nozzles are installed by more contractors than all other brands combined.
- Quickly identify radius and arc with Top Color-coded™ nozzles even when system is not operating.
- Three year trade warranty.



Description	Inventory Code	Carton QTY	Min Order QTY
5' - 1.5m MPR Nozzle - Quarter Circle (A47084)	5Q	25	25
5' - 1.5m MPR Nozzle - Half Circle (A47083)	5H	25	25
5' - 1.5m MPR Nozzle - Full Circle (A47086)	5F	25	25
8' - 2.4m MPR Nozzle - Quarter Circle (A4702001)	8Q	25	25
8' - 2.4m MPR Nozzle - Half Circle (A4701901)	8H	25	25
8' - 2.4m MPR Nozzle - Full Circle (A4701801)	8F	25	25
10' - 3.0m MPR Nozzle - Quarter Circle (A47017)	10Q	25	25
10' - 3.0m MPR Nozzle - Half Circle (A47016)	10H	25	25
10' - 3.0m MPR Nozzle - Full Circle (A47015)	10F	25	25
12' - 3.6m MPR Nozzle - Quarter Circle (A47014)	12Q	25	25
12' - 3.6m MPR Nozzle - Half Circle (A47012)	12H	25	25
12' - 3.6m MPR Nozzle - Full Circle (A47009)	12F	25	25
15' - 4.6m MPR Nozzle - Quarter Circle (A47005)	15Q	25	25
15' - 4.6m MPR Nozzle - Half Circle (A47070)	15H	25	25
15' - 4.6m MPR Nozzle - Full Circle (A47000)	15F	25	25
15' - 4.6m MPR Nozzle - Centre Strip 15CST (A47007)	15CST	25	25
15' - 4.6m MPR Nozzle - End Strip 15EST (A47006)	15EST	25	25
15' - 4.6m MPR Nozzle - Left Corner Strip 15LCS (A47033A)	15LCS	25	25
15' - 4.6m MPR Nozzle - Right Corner Strip 15RCS (A47034A)	15RCS	25	25
15' - 4.6m MPR Nozzle - Side Strip 15SST (A47008)	15SST	25	25
9' - 2.7m MPR Nozzle - Side Strip 9SST (A47047)	9SST	25	25

VAN Nozzles - Variable Arc Nozzles

- A simple twist of the centre collar with no special tools increases or decreases the arc setting making it ideal for watering odd shaped areas.
- Quickly identify radius with Top Color-coded™ nozzles even when system is not operating.
- 12, 15, and 18-VAN have matched precipitation rates with Rain Bird MPR Nozzles.
- Three year trade warranty.



Description
4' - 1.2m VAN Nozzle (P10004)
6' - 1.8m VAN Nozzle (P10006)
8' - 2.4m VAN Nozzle (P10008)
10' - 3.0m VAN Nozzle (P1001001)
12' - 3.6m VAN Nozzle (P1001201)
15' - 4.6m VAN Nozzle (P1001501)
18' - 5.5m VAN Nozzle (P10018)

Inventory Code	Carton QTY	Min Order QTY
4VAN	25	25
6VAN	25	25
8VAN	25	25
10VAN	25	25
12VAN	25	25
15VAN	25	25
18VAN	25	25

HE-VAN Nozzles - High Efficiency Variable Arc Nozzles

- HE-VAN's even coverage allows you to shorten run times by up to 35%, saving you water and money, while still maintaining a healthy lawn.
- HE-VAN has more than a 40 percent even-coverage improvement over existing variable arc nozzles.
- HE-VAN nozzles have a unique stream pattern, designed for superior coverage and wind resistance. Low-trajectory spray and large water droplets prevent misting and airborne evaporation so the right amount of water is delivered to the right place. Gentle close-in watering eliminates dry-spots around the spray head.
- HE-VAN nozzles throw to the exact specified radius, delivering the cleanest edge of any VAN on the market today.
- Reduced zone run times, compared to competitive nozzles, help stay within tight watering windows, conserve water, and save money.
- With full adjustability from 0° to 360°, you'll be able to efficiently water landscapes of all shapes, while saving time and stocking fewer nozzles.
- Matched precipitation rates allow you to install Rain Bird HE-VAN, MPR and U-Series nozzles on the same zone.
- HE-VAN nozzles have a tactile click to keep the arc setting from drifting over time.
- Three year trade warranty.



Description
8' - 2.4m HE-VAN Nozzle (HE0801)
10' - 3.0m HE-VAN Nozzle (HE1001)
12' - 3.6m HE-VAN Nozzle (HE1201)
15' - 4.6m HE-VAN Nozzle (HE1501)

Inventory Code	Carton QTY	Min Order QTY
HE-VAN-8	25	25
HE-VAN-10	25	25
HE-VAN-12	25	25
HE-VAN-15	25	25

*indent only

R-VAN Rotary Nozzles

High Efficiency, Multi-Stream.

Rain Bird® R-VAN Adjustable Rotary Nozzles save more water, are easier to use, and are lower priced compared to leading rotating nozzles. R-VANs thick streams and large water droplets cut through the wind to deliver water where you want it. R-VANs are easier to use thanks to its hand-adjustable arc and radius.

- Matched precipitation across radius, arcs, and pattern types.
- Low precipitation rate reduces run-off and erosion.
- Adjust arc and radius without tools.
- A pull-up to flush feature clears the nozzle of dirt and debris.
- Maintains efficient performance at high operating pressures without misting or fogging.
- Compatible with all models of Rain Bird spray bodies, risers and adapters.
- Installing with Rain Bird 5000 MPR Series Rotors allows for matched precipitation from 2.4m to 10.7m.
- Three year trade warranty.



Description
8-14' - 2.4-4.3m Adjustable Arc Nozzle (45 to 270 degrees) (A84659)
13-18' - 4.0-5.5m Adjustable Arc Nozzle (45 to 270 degrees) (A84660)
17-24' - 5.2-7.3m Adjustable Arc Nozzle (45 to 270 degrees) (A84661)
8-14' - 2.4-4.3m Full Circle Nozzle (A84664)
13-18' - 4.0-5.5m Full Circle Nozzle (A84665)
17-24' - 5.2-7.3m Full Circle Nozzle (A84666)
R-Van Rotary Nozzle Left Side Strip 1.5-4.6m (A84667)
R-Van Rotary Nozzle Right Corner Strip 1.5-4.6m (A84668)
R-Van Rotary Nozzle Side Strip Centre 1.5 x 9.1m (A84669)

Inventory Code	Carton QTY	Min Order QTY
RVAN-14	10	10
RVAN-18	10	10
RVAN-24	10	10
RVAN-14F	10	10
RVAN-18F	10	10
RVAN-24F	10	10
R-VAN-LCS	10	10
R-VAN-RCS	10	10
R-VAN-SST	10	10

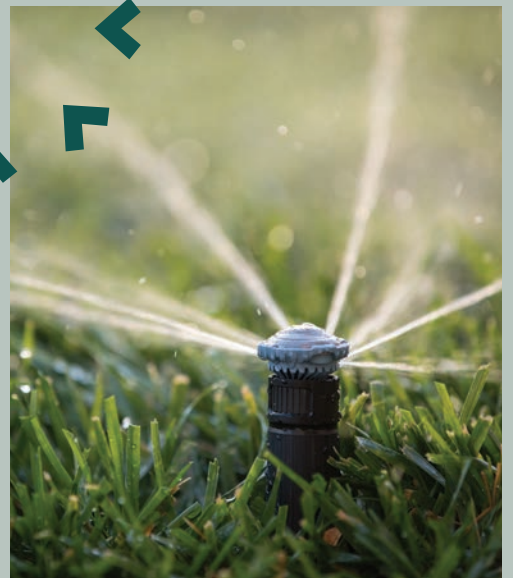
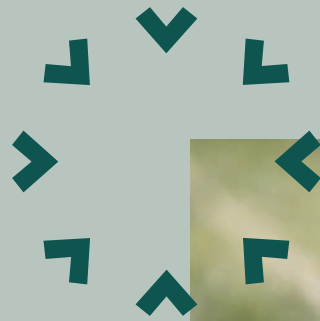



Sprinklers - Rotors



3500 Series Rotor Pop Up Sprinklers - 1/2" Inlet

Compact Residential Rotor. Big on value and convenience.

- Rain Curtain™ nozzles deliver even distribution over the entire radius including large wind resistant droplets and gentle close-in watering resulting in greener turf using less water.
- Oversized wiper seal prevents leaks and protects internals from debris.
- Arc adjustment through the top of the rotor requiring only a flat-blade screwdriver.
- Three year trade warranty.



Description
3500, 4" Part/Reverse Full Circle Rotor (Incl Nozzles) (Y34000)
3500, 4" Part/Reverse Full Circle Rotor + SAM (Incl Nozzles) (Y34500)

Inventory Code	Carton QTY	Min Order QTY
3504PC	20	
3504PCS	20	

5000 Plus Series Rotor Pop-Up Sprinkler - 3/4" Inlet

Engineered to be the industry's most reliable and best performing rotor.

- Oversized wiper seal prevents leaks and protects internals from debris.
- Rain Curtain™ nozzles deliver even distribution over the entire radius including large wind resistant droplets and gentle close-in watering resulting in greener turf using less water.
- A history of proven performance and reliability tested in millions of installations.
- Self-flushing arc adjustment port that prevents buildup of debris.
- Five year trade warranty.



Description
5004, 4" Full Circle Rotor (Incl Nozzles) (Y54017)
5004, 4" Part/Reverse Full Circle Rotor (Incl Nozzles) (Y54007)
5004 Plus, 4" Full Circle Rotor (Incl Nozzles) (Y45010)
5004 Plus, 4" Full Circle Rotor with SAM - PRS (Incl Nozzles) (Y65655)
5004 Plus, 4" Part/Reverse Full Circle Rotor (Incl Nozzles) (Y45000)
5004 Plus, 4" Part/Reverse Full Circle Rotor with SAM (Incl Nozzles) (Y45650)
5004 Plus, 4" Part/Reverse Full Circle Rotor with SAM - PRS (Incl Nozzles) (Y65650)
5004 Plus, 4" Part/Reverse Full Circle Rotor with SAM - PRS - NP (Y65670NP)
5006 Plus, 6" Part/Reverse Full Circle Rotor with SAM (Incl Nozzles) (Y45850)
5012 Plus, 12" Part/Reverse Full Circle Rotor with SAM - PRS (Incl Nozzles) (Y66050)
5012 Plus, 12" Part/Reverse Full Circle Rotor with SAM - PRS - NP (Y66070NP)

Inventory Code	Carton QTY	Min Order QTY
5004FC	20	
5004PC	20	
5004PLFC	20	
5004PLFCSR	20	
5004PLPC	20	
5004PLPCS	20	
5004PLPCSR	20	
*5004PLPCSRNP	20	
5006PLPCS	20	
5012PLPCSR	20	
5012PLPCSRNP	20	

*indent only

5000 Plus Series Rotor Pop-Up Sprinkler - 3/4" Inlet - Stainless Steel Riser

- Stainless steel (SS) riser helps deter vandalism on public turf areas (available on 5004 and 5006 models).

Description
5004 Plus, 4" Full Circle Rotor with SAM - PRS - SS (Incl Nozzles) (Y65755SS)
5004 Plus, 4" Part/Reverse Full Circle Rotor with SAM - PRS - SS (Incl Nozzles) (Y65750SS)
5004 Plus, 4" Part/Reverse Full Circle Rotor with SAM - PRS - SS - NP (Incl Nozzles) (Y65770SSNP)
5006 Plus, 6" Part/Reverse Full Circle Rotor with SAM - PRS - SS (Y65950SS)



Inventory Code	Carton QTY	Min Order QTY
5004PLFCSSRS	20	
5004PLPCSSRS	20	
5004PLPCSSRSNP	20	
*5006PLPCSSRS	20	

6504 Series Rotor Pop-Up Sprinklers - 1" Inlet (Complete with #10, #12, #14, #16, #18 Nozzles)

Reliable and Economical Falcon® Sprinkler.

- Ratcheting stem just like standard spray bodies.
- 3-port, colour-coded Rain Curtain nozzles for optimal long range, midrange, and close-in watering.
- SAM Seal-A-Matic check valve.
- Self-adjusting stator does not require replacement when changing nozzles.
- Heavy-duty, stainless steel retract spring ensures positive pop-down.
- Five year warranty.

Options

- Stainless steel (SS) riser helps deter vandalism on public turf areas.
- Purple cover (NP) for non-potable systems.

Description
6504 Falcon Full Circle with SAM (Incl Nozzles) (B65311)
6504 Falcon Part Circle with SAM (Incl Nozzles) (B65301)
6504 Falcon Full Circle with SAM - SS (incl Nozzles) (B65811)
6504 Falcon Part Circle with SAM - SS (Incl Nozzles) (B65801)
6504 Falcon Full Circle - SS - NP (B65831NP)
6504 Falcon Part Circle - SS - NP (B65821NP)



Inventory Code	Carton QTY	Min Order QTY
IF4FC	12	
IF4PC	12	
IF4FCSS	12	
IF4PCSS	12	
IF4FCSSNP	12	
IF4PCSSNP	12	

8005 Series Rotor Pop-Up Sprinklers - 1" Inlet

(Complete with #10, #12, #14, #16, #18 Nozzles).

Protect Your Turf with High Performance, Vandal and Abuse Resistant Rotors from 11.9 to 24.7 m.

- Vandal resistance, brass reinforced turret for increased side impact durability.
- Memory Arc® returns the rotor to its original arc setting.
- Non-strippable drive mechanism prevents damage from vandals.
- Easy, wet, dry arc adjustment with slotted screwdriver through top of rotor from 50° to 330° part-circle, 360° non-reversing full-circle. Full and part circle operation in one unit.
- Left and right side trips adjustable for ease of installation without turning the case and loosening the pipe connection.
- SAM Seal-A-Matic check valve.
- 3-port, colour-coded Rain Curtain nozzles for optimal long-range, midrange, and close-in watering.
- Five year warranty.

Options

- Stainless steel (SS) riser helps deter vandalism on public turf areas.
- Purple cover (NP) for non-potable systems.



Description	Inventory Code	Carton QTY	Min Order QTY
8005, 5" Part/Full Circle Rotor with SAM (Incl Nozzles) (B81200)	I8005	12	
8005, 5" Part/Full Circle Rotor with SAM - NP (B81200NP)	*I8005NP	12	12
8005, 5" Part/Full Circle Rotor with SAM - SS (Incl Nozzles) (B81400)	I8005SS	12	
8005, 5" Part/Full Circle Rotor with SAM - SS - NP (B81400NP)	I8005SSNP	12	

11000 Series Rotor Pop-Up Sprinklers - 1.5" ACME Inlet

The Rain Bird 11000 Series Rotor is specifically designed for use on sports fields and large commercial turf applications. Providing excellent water distribution uniformity over a full 32.0 m radius, makes this rotor ideal for sports fields and reduces the number of heads required. With a small exposed head and included rubber cover, this rotor is designed for in-field use and therefore can irrigate fields 25% larger than 1" rotors with 40% fewer rotors.

- Water-lubricated, gear-driven pop-up rotor.
- Top-serviceable rock screen.
- Seal-A-Matic (SAM) check valve to help prevent low-head drainage.
- Heavy-duty stainless steel retract spring ensures positive popdown.
- Standard rubber black cover.
- Available in non-reversing full-circle and 30-345° reversing part circle. Full and part circle operation in one unit.
- Five year trade warranty.



Description
11000 Series 4" ACME W/ #56 (B11056)
SOD CUP, 11000 Series
TURF COVER, 11000 Series
TURF COVER-GREEN, 11000 Series
TURF COVER-NP, 11000 Series

Inventory Code	Carton QTY	Min Order QTY
RB1100456	4	
RBSODCUPXL		
*RBCOVERXL		
*RBCOVERXLS		
RBCOVERXLNP		

Rotor Sprinklers Nozzle Kits

3500 Series Nozzle Tree



5000 Series Nozzle Tree



6504 + 8005 Series Nozzle Kit



Description	Inventory Code	Carton QTY	Min Order QTY
3500 Series Nozzle Tree - STD Rain Curtain (Y03500)	3500RCTREE	25	
5000 Series Nozzle Tree - MPR (Pack of 30 - 10 x 25', 10 x 30', 10 x 35') (Y046MPK)	5000MPRMPK	1	
5000 Series Nozzle Tree - STD Rain Curtain (Y04500)	5000RCTREE	25	
6504 + 8005 Series Low Flow Nozzle Kit #4, #6, #8 (B81610)	RAINNOZ-LF	3	
6504 + 8005 Series Standard Flow Nozzle Kit #10, #12, #14, #16, #18 (B81620)	RAINNOZ-SF	5	
8005 Series High Flow Nozzle Kit #20, #22, #24, #26 (B81630)	RAINNOZ-HF	4	
NOZ #44 BLUE, 11000 Series	RB11000NOZ44		
NOZ #48 YELLOW, 11000 Series	RB11000NOZ48		
NOZ #52 ORANGE, 11000 Series	RB11000NOZ52		
NOZ #56 GREEN, 11000 Series	RB11000NOZ56		
NOZ #60 BLACK, 11000 Series	RB11000NOZ60		
NOZ #64 RED, 11000 Series	RB11000NOZ64		
NOZ TAIL PLUG, 11000 Series	*RB11000PLUG		
NOZ TAIL GREEN, 11000 Series	*RB11000TAIL		



Impact Sprinklers



Brass Impact Sprinklers

3/4" (19mm) Full Circle, Brass Impact Sprinkler.

- Heavy duty brass construction.
- Stainless steel springs and fulcrum pin.
- Chemically resistant washers.
- Dual nozzle ports.
- Corrosion and grit resistant.
- Built to last.
- Five year warranty.

Description
30H RB Impact Sprinkler - 20mm BSP (A08401)
30H RB Impact Sprinkler Brass Nozzles 3/16 4.76mm with Vane (106131-12)
30H RB Impact Sprinkler Blank Plug (100255)



Inventory Code	Carton QTY	Min Order QTY
30H	5	
30H3/16NOZ	5	
30HBP	5	

Maxipaw Series Impact Pop-Up Sprinklers

Dirty water applications - spacing up to 13.7 m.

- Proven impact drive with straight-through flow for superior performance in dirty water.
- Five standard trajectory colour-coded nozzles for matched precipitation and in a wide range of applications.
- 360° full-circle OR arc adjustable from 20° to 340°.
- Side and combination 1/2" or 3/4" bottom inlet for design flexibility (Maxi-Paw).
- Three year warranty.

Description
Rain Bird Maxipaw Part/Full Circle Impact Sprinkler (B0690008)
Rain Bird Maxipaw Part/Full Circle Impact Sprinkler - SAM (B0610008)
Maxi Bird RB Impact Sprinkler - 15mm BSP PC/FC (B4600008)
Maxipaw Series Nozzle #6 Red (20659206)
Maxipaw Series Nozzle #7 Black (20659207)
Maxipaw Series Nozzle #8 Blue (20659208)
Maxipaw Series Nozzle #10 Yellow (20659210)
Maxipaw Series Nozzle #12 Beige (20659212)



Inventory Code	Carton QTY	Min Order QTY
*2045A	20	20
2045ASAM	20	
2045PJ	20	
2045NOZ06	25	
2045NOZ07	25	
2045NOZ08	25	
2045NOZ10	25	
2045NOZ12	25	

LF Series Sprinklers

The Rain Bird® LF™ Series Sprinkler is built to withstand the harsh conditions of a variety of agricultural applications. Leveraging the advantages of an impact sprinkler, the LF Series Sprinkler offers full circle operation with stream height flexibility to deliver precise, uniform, and unrivaled water distribution.

- ½" (13mm) NPT male pipe thread.
- Weighted drive unit increases dwell time between stream interruptions to maximize throw distance.
- Precision Jet (PJ) spoon directs water toward the field to prevent erosion at the riser base.
- Deflector's made of engineered thermoplastic for wear resistance and dimensional stability and designed with break-up features to optimise uniformity.
- Consistent performance in wide temperature range: ideal for cooling or frost protection.
- Snap-in-place colour-coded nozzles and deflectors for simple setup and easy field identification – no tools required.
- Five year warranty.



Description
LF1200 17DEG BLU 44ORNG
LF2400 22DEG DKGR, 30TAN
LF2400 Long Range GREY NOZ 27 DEFLECT
LF Sprinkler Edge Guard (118366)
LF Sprinkler Stream Splitter (118259)

Inventory Code	Carton QTY	Min Order QTY
LF1200-17-BL-OR	100	
LF2400-22-DKGR-TA	100	
LF2400-27-GY-BL	100	
LF118366		
LF118259		





Sprinkler Accessories



Articulated Risers

SA Series

- The operating range of the Rain Bird Swing assemblies matches or exceeds the operating range for most 15mm sprays and 20mm rotors.
- Operating pressure: Up to 5.5 bar.
- Maximum flow: 0.5 l/sec.
- Three year warranty.

SJ Series

- Pressure Rating: 315 psi (21.7 bar) at 73°F (22.8°C)
- Superior flow characteristics. An innovative swept elbow design reduces pressure loss by up to 50 percent over other swing joints.
- Double O-ring protection. Provides a better seal to ensure that joints are kept clean and can be repositioned easily.
- Extended Warranty: When used with Rain Bird golf rotors, extends rotor and swing joint warranty to five years.

Swing Articulated Riser



Swint Joint - PVC



Description	Inventory Code	Carton QTY	Min Order QTY
Swing Articulated Riser - 15x150mm - 1800/RD1800, 3500 Series (A48030)	SA6050	75	
Swing Articulated Riser - 15x300mm - 1800/RD1800, 3500 Series (A48035)	SA125050	50	
SWING JOINT 20 x 15 x 300 mm	SJ2015300		
SWING JOINT 20 x 20 x 300 mm	SJ2020300	10	
Rigid Articulated Riser 20x300mm - 5000, 5500 Series (AR20-300)	AR20-300	50	
Swing Joint PVC - 25x25x300mm BSPxBSP - 6504, 8005, QC Valves (JB000022)	ISJ1210022	15	
Swing Joint PVC - 40mm x 40mm x 300mm ACME x BSP	ISJ000023		
Swing Joint 32mm BSP-ACME	SJ1212523	10	
Swing Joint 40mm BSP-ACME	SJ1215023	10	10
Swing Joint PVC - 25x300mm with PRS 70psi (A66755)	*TSJ100PRS	15	
40mm BSP Female To ACME Male Adaptor	BSPACME40		
Spiral Barb Coupler - 15mm (A46006)	SBCPLG		
Spiral Barb Elbow - 15mm (A46010)	SBE050	200	
Spiral Barb Elbow - 20mm (A46011)	SBE075	200	
Spiral Barb Tee - 15mm (A46004)	SBTEE		

Sprinkler Tools



Description
Rotor Hold Up Tool with Bubble Level for 6504/8005 (232693S)
Green Handle Flat Head Tool with Pull Up Feature (Y05100)
Spray Head Pull Up Tool (N89900)
Key, Selector VLV Eagle
Snap Ring Pliers 700/750
Valve Insertion Tool 700/750
Installation Wrench - Maxi Paw (B41866)



Inventory Code	Carton QTY	Min Order QTY
HOLDUPTOOL	1	
ROTORTOOL	1	
PTC1	1	
EGLSVK	1	
SR700	1	
VT700	1	
42064	1	

Marker Flags



Description
Rain Bird Marker Flag - Blue - Bundle of 100 (V90104A)
Rain Bird Marker Flag - Green - Bundle of 100 (V90108A)
Rain Bird Marker Flag - Orange - Bundle of 100 (V90106A)
Rain Bird Marker Flag - Pink - Bundle of 100 (V90105A)
Rain Bird Marker Flag - White - Bundle of 100 (V90058A)
Rain Bird Marker Flag - Yellow - Bundle of 100 (V90107A)

Inventory Code	Carton QTY	Min Order QTY
FLAGBLUE	1	
FLAGGREEN	1	
FLAGORANGE	1	
FLAGPINK	1	
FLAGWHITE	1	
FLAGYELLOW	1	





Control Valves



DV Series Valves

Diaphragm Valve – the industry leader for over 25 years.

- Double-filtered (diaphragm and solenoid) pilot-flow design for maximum reliability and grit resistance.
- Buna-N, balanced pressure diaphragm with self-cleaning 200 micron pilot water filter and captive spring.
- Energy-efficient, low-power encapsulated solenoid with captured plunger and 200 micron solenoid filter.
- Unique, easy-to-turn pressure assisted flow control mechanism (DVF models only).
- External bleed to manually flush system of dirt and debris during installation and system start-up.
- Internal bleed for spray-free manual operation.
- Accepts Rain Bird TBOS latching solenoid for use with most battery operated controllers.
- Operates in low-flow and landscape drip applications when a 200 mesh filter is installed upstream.
- Not recommended for use with two-wire control systems.
- Pressure: 1.0 to 10.4 bar.
- Flow: 0.8 to 151.4l/min.
- Five year warranty.



Description
20mm Drip Zone Kit - Low Flow DV Vlv & PR Filter 30psi
20mm DC Drip Zone Kit - Low Flow DV Vlv, DC Coil & PR Filter 30psi (X10325)
25mm DV Valve BSP - without Flow Control (B7021f)
25mm DV Valve BSP - with Flow Control (B7031f)
25mm DV Valve 9VDC latch BSP - with Flow Control (B70350)

Inventory Code	Carton QTY	Min Order QTY
RBX10306	1	
RBX10325	1	
H100DV	20	
H100DVF	20	
H100DVFCL	20	

HV (High Value) Series Valves

High value valve. High performance. Big savings.

- Patented, eccentric, balanced pressure, Buna-N diaphragm with self-cleaning 200 micron pilot water filter and captured stainless steel spring – Eccentric design provides smoother closing, less water hammer.
- Only four durable, captured multi-drive bonnet screws that come out with half the number of turns for fast and easy servicing – at least twice as fast as the competition.
- Glass-filled polypropylene body for strength (slip by slip model bodies are PVC).
- Pressure: 1.0 to 10.3 bar.
- Flow: 0.8 to 113.67l/min.
- Three year warranty.



Description
25mm HV Valve BSP - without Flow Control (H01000)
25mm HV Valve BSP - with Flow Control (H01010)
25mm HV Valve Slip x Slip - without Flow Control (H02000)

Inventory Code	Carton QTY	Min Order QTY
H100HVBSP	1	20
H100HVFBSBP	1	20
H100HVSS	1	20

PGA Series Valves

Plastic Globe and Angle Valves. The toughest, most reliable valves in their class.

- Water-tight seal between the body and bonnet for maximum confidence, even in the most extreme conditions.
- Robust construction and electrical design for quiet performance you can count on.
- Filtered pilot flow to resist debris and clogging.
- Slow closing to prevent water hammer and subsequent system damage.
- Normally closed, forward flow design.
- Accepts latching solenoid for use with Rain Bird battery-operated controllers.
- Multi-drive screws (Phillips, flathead, hexagonal) for easy maintenance.
- Manual internal bleed operates the valve without allowing water into the valve box. This allows the pressure regulator to be adjusted without turning the valve on at the controller.
- One-piece solenoid design with captured plunger and spring for easy servicing. Prevents loss of parts during field service.
- Accommodates optional, field-installed PRS-D pressure regulating dial to ensure optimum sprinkler performance.
- Accepts latching solenoid for use with Rain Bird battery-operated controllers.
- Pressure: 1.04 to 10.4 bar.
- Flow without PRS-D option: 7.8 to 568 l/m.
- Flow with PRS-D option: 19.2 to 568 l/m.
- Three year trade warranty.



Description
25mm PGA Valve Globe/Angle Configuration - BSP (B31410)
40mm PGA Valve Globe/Angle Configuration - BSP (B31510)
50mm PGA Valve Globe/Angle Configuration - BSP (B31610)

Inventory Code	Carton QTY	Min Order QTY
I100PGA	10	
I150PGA	8	
I200PGA	4	

PEB Series Valves

Best-in-class Professional Series Plastic Irrigation Valves.

- Durable glass-filled nylon construction with fabric-reinforced rubber diaphragm for long life and reliable performance.
- Globe configuration.
- Normally closed, forward flow design.
- Slow closing to prevent water hammer and subsequent system damage.
- Low flow capability for a wide range of applications.
- One-piece solenoid design with captured plunger and spring for easy servicing. Prevents loss of parts during field service.
- Flow control handle adjusts water flows as needed.
- Manual internal bleed manually operates the valve without allowing water into the valve box; allows pressure regulator to be adjusted without turning the valve on at the controller first.
- Manual external bleed permits flushing debris from the system. Recommended for system start up and after repairs.
- Stainless steel studs molded into the body. Bonnet can be attached and removed more easily and more often without damaging threads.
- Nylon scrubber scrapes a stainless steel screen to clean and break down grit and plant material. Prevents debris build-up and clogging (PESB Series only).
- Pressure: 1.4 to 13.8 bar.
- Flow without PRS-D option: 1.2 to 750l/min.
- Flow with PRS-D option: 19 to 1133.33 l/min.
- Five year trade warranty.



Description	Inventory Code	Carton QTY	Min Order QTY
25mm PEB Valve Globe Configuration - BSP (B34073)	I100PEB	10	
40mm PEB Valve Globe Configuration - BSP (B34083)	I150PEB	8	
50mm PEB Valve Globe Configuration - BSP (B34093)	I200PEB	8	
25mm PEB Valve Globe Configuration - BSP - with Scrubber (B37073)	I100PESB	10	
40mm PEB Valve Globe Configuration - BSP - with Scrubber (B37083)	I150PESB	8	
50mm PEB Valve Globe Configuration - BSP - with Scrubber (B37102)	I200PESB	8	
25mm PEB Valve - BSP - with Scrubber & Reclaimed Water Kit (B37210)	I100PESBR	10	
40mm PEB Valve - BSP - with Scrubber & Reclaimed Water Kit (B37310)	I150PESBR	8	

BPE Series Valves - 80MM

3" Brass Master Valve - globe and angle configuration.

- Unique hybrid construction featuring durable red brass body and glass-filled nylon bonnet for long life at a value price.
- Normally closed, forward flow design.
- Slow closing to prevent water hammer and subsequent system damage.
- Robust solenoid provides dependable performance even during constant operation.
- Flow control handle adjusts water flows as needed and incorporates a brass thread insert for longer life.
- Manual internal bleed operates the valve without allowing water into the valve box. Allows pressure regulator adjustment without turning the valve on at the controller.
- Manual external bleed permits flushing debris from the system. Recommended for system start up and repairs.
- Highly efficient operation with extremely low pressure loss.
- Patented nylon scrubber scrapes a stainless steel screen to clean and break down grit and plant material. Prevents debris build-up and clogging.
- Pressure: 1.4 to 13.8 bar.
- Flow with/without PRS-D option: 226.67 to 1135 l/min.
- Three year trade warranty.



Description

80mm BPE Brass Valve - BSP - with Scrubber (B38213)

Inventory Code

*RBB38213

Carton QTY

1

Min Order QTY

1





Control Valve Accessories



Manifolds

A complete range of solenoid valves and manifolds for a easy installation and a maintenance with no comparison.

- PN12 PVC.
- Floating nut for easy assembly.
- BSP threaded.



Description	Inventory Code	Carton QTY	Min Order QTY
MANIFOLD TEE 1" FxFxM with O-Ring	M25TEE	120	
MANIFOLD 2 PORTS 1" with O-Ring	M25TEE2	60	
MANIFOLD 3 PORTS 1" with O-Ring	M25TEE3	50	
MANIFOLD 4 PORTS 1" with O-Ring	M25TEE4	40	
MANIFOLD NIPPLE 1" with O-Ring	M25NIPPLE	400	
MANIFOLD NIPPLE 1"x3/4" with O-Ring	M2520NIPPLE	400	
MANIFOLD CAP 1" with O-Ring	M25CAP	20	
MANIFOLD ELBOW 1" FxF with O-Ring	M25ELBOWFF	160	
MANIFOLD ELBOW 1" MxF with O-Ring	M25ELBOWMF	160	
MANIFOLD CROSS 1" MxFxFxF with O-Ring	M25CROSSMF	80	
MANIFOLD COUPLING 1" FxF with O-Ring	M25COUPLER	240	
MANIFOLD ADAPTOR 1" MxF with O-Ring	M25ADAPTOR	300	

Pressure Regulators and Filters

PRS-Dial - Pressure Regulating Module

- The PRS-Dial is an excellent means of regulating outlet pressure at the valve regardless of incoming pressure fluctuations. The visible scale makes adjustment quick and easy.
- The regulator fits all Rain Bird PGA, PEB, PESB, PESB-R, EFB-CP, and BPES series valves.
- Regulates and maintains constant outlet pressure between 1.04 to 6.9 bar within +/- 0.21 bar.
- Ergonomic design with snap-tight cover to prevent vandalism.
- Waterproof dial cartridge eliminates fogging and binding.
- Schrader valve connects pressure hose gauge.
- Easy field installation. PRS-Dial threads underneath the solenoid and adapter.
- Corrosion-resistant glass-filled nylon for rugged performance.
- Flow Range: Refer to solenoid valves above.
- Three year warranty.



Inline Pressure Regulators

- Can be installed above or below grade.
- Preset outlet pressure: 1.0 to 2.1 bar.
- 3/4" NPT female-threaded inlet and outlet.
- Three year warranty.



RBX Filters

- A simple and reliable filter for low-volume irrigation systems.
- Simple to clean, as cap has a sealing O-ring and unthreads to provide access to the stainless steel filter element.
- Strong and reliable due to its robust design and glass-filled polypropylene construction.
- Male x Male threaded connections for direct connection to valves and pressure regulators.
- Pressure-regulated models regulate pressure to a nominal 30 or 40 psi (2.0 or 2.8 bar).
- Three year warranty.



Description
PRS Dial Adjustable Pressure Regulator (B33135)
20mm Pressure Regulator 30 psi - low flow 0.8 to 18.9 l/m (X15000)
20mm Pressure Regulator 30 psi - 7.5 to 83 l/m (X15050)
20mm Pressure Regulator 40 psi - 7.5 to 83 l/m (A8860050)
20mm Pressure Regulating RBY Filter 30 psi, 200 Mesh - 0.8 to 18.9 l/m (X13000)
25mm Pressure Regulating RBY Filter 40 psi, 200 Mesh - 11.4 to 56.8 l/m (X13013)
20mm RBY Filter, 200 Mesh - 0.8 to 45.4 l/m (X14004)
25mm RBY Filter, 200 Mesh - 0.8 to 68.1 l/m (X14052)

Inventory Code	Carton QTY	Min Order QTY
PRSDIAL	10	
PSIL30	5	
PSIM30	5	
PSIM40	5	
RBX13000	5	
PRF-100RBY	5	
RBX14004	5	
RBX14052	5	

Solenoid Coils and Adaptors

Description
Potted Latching Solenoid - 9V DC suits all Rain Bird Valves (K80920)
DV Solenoid with Filter (20858801)
PGA, PEB Solenoid (236239)
TBOS Adaptor - Non-Rain Bird Plastic Valves to TBOS Solenoid (K80510)
TBOS Adaptor - Non-Rain Bird Brass Valves to TBOS Solenoid (K80610)

Inventory Code	Carton QTY	Min Order QTY
PLSDC	8	
RB20858801	1	
SOLASSG4	1	
TBOSADAPP	16	
TBOSADAPB	8	



Control Valve Spare Parts

Description
Diaphragm Assembly DV, DVF (21074603)
Diaphragm Assembly 100 PGA (209792)
Diaphragm Assembly 150 PGA (209675)
Diaphragm Assembly 200 PGA (209005)
Diaphragm & Bonnet Assembly 100 PEB (208143)
Diaphragm & Bonnet Assembly 150 PEB (236482)
Diaphragm & Bonnet Assembly 150 PESB (23648401)
Diaphragm & Bonnet Assembly 200 PEB (236483)
Diaphragm & Bonnet Assembly 200 PESB (23648501)
PEB/PESB Handle 25mm - NP (231230)
PEB/PESB Handle 40mm, 50mm - NP (231232)
Diaphragm Assembly 300BPES (231542)
Reclaimed diaphragm for PESB 50mm/40mm - diaphragm and scraper filter (20851804S+)

Inventory Code	Carton QTY	Min Order QTY
RB21074603	1	
RB209792	1	
RB209675	1	
RB209005	1	
RB208143	1	
RB236482	1	
*RB23648401	1	1
RB236483	1	
RB23648501	1	
RB231230	1	
RB231232	1	
RB231542	1	
*RB20851804S	1	



Quick Coupling Valves



QCV - Rain Bird

- Brass construction.
- Thermoplastic cover for durability.
- Stainless steel internal valve spring prevents leakage.

5RC

- Flow: 7.0 to 16.0 m³/h.
- Pressure: 0.4 to 8.6 bar.
- Three year warranty.

Stabiliser

- Class 350 ductile iron per ASTM A-536.
- Epoxy Coating.
- 304 Stainless Steel hardware.

Description

20mm P33 Plastic Quick Coupling Valve (LP3300)
20mm P33DK Plastic Quick Coupling Key - Single Lug (LP3310)
20mm 3RC Quick Coupling Valve - 1 Piece Body, Rubber Cover (B10603)
20mm 3DRC Quick Coupling Valve - 2 Piece Body, Rubber Cover (B11502)
20mm 33D Quick Coupling Valve Key, Suit 3RC, 3 DRC, 33D NP. Double Lug (B11801)
20mm 3DNP Quick Coupling Valve - 2 Piece Body, NP Rubber Cover (B11525)
25mm 5RC Quick Coupling Valve - 1 Piece Body, Rubber Cover (B12803)
25mm 55K Quick Coupling Valve Key - Single Lug (B13401)
40mm 7K Quick Coupling Valve - 1 Piece Body, Standard Cover (B14600)
40mm 7K Quick Coupling Valve Key (B14700)
QCV Gasket for 5RC, 5LRC & 5NP (200278)
QCV Repair Kit for 5RC, 5LRC & 5NP (203747)
20mm, 25mm Quick Coupling Stabiliser (V35126)
20mm Hose x 20mm NPT Swivel Elbow (B40001)
25mm Hose x 25mm BSP Swivel Elbow (B40103)



Inventory Code	Carton QTY	Min Order QTY
*RBLP3300	10	
*RBLP3310	10	
*RBB10603	1	
*RBB11502	1	
*33DK	1	
*33DNP	1	
RBB12803	1	
*RBB13401	1	
*RBB14600	1	
*RBB14700	1	
RB200278	1	
RB203747	1	
RBV35126	1	
*RBB40001	1	
*RBB40103	1	

QCV - Other

- Industrial-strength brass quick-coupling valves for convenient water access in potable and non-potable systems.
- Rugged, red brass construction for long life and reliable performance.
- Reliable operation with strong corrosion-resistant stainless steel spring.

Description

Brass Quick Valve/Coupler 25mm
Brass Quick Coupler Key 25mm
Brass Quick Valve/Coupler 40mm
Brass Quick Coupler Key 40mm
Brass Swivel for Hydropod 25mm x 90 Degree
Brass Swivel for Hydropod 40mm x 90 Degree



Inventory Code	Carton QTY	Min Order QTY
QCV25	1	
QCK25	1	
QCV40	1	
QCK40	1	
SE2590	1	
SE4090	1	

*indent only



Valve Boxes



PVB Series Valve Boxes

The PVB Series valve box provides rugged, no-nonsense dependability, with a price tag that can meet any budget.

- Light and durable construction.
- Side ridges for additional side wall support.
- Pre-molded pipe slots.
- Bottom flanges to help prevent sinking.
- Multiple configurations designed to provide tight seals and easy maintenance access.
- Three year warranty.



Description
6"/150mm Round Valve Box with Green Lid (A12523)
10"/250mm Round Valve Box with Green Lid (A12519)
Valve Box Standard Rectangular with Green Lid (A12500)
Valve Box Standard Rectangular - 6"/150mm Extension with Green Lid (A12504)
Standard Rectangular PVB Valve Box with Purple Lid (A12502)
Jumbo Valve Box with Green Lid (A12508)
Jumbo Valve Box 6"/150mm Extension with Green Lid (A12512)

Inventory Code	Carton QTY	Min Order QTY
PVB6RND	1	
PVB10RND	1	
PVBSTD	1	
PVBSTDEXT	1	
PVBSTDTP	1	
PVBJMB	1	
PVBJMBEXT	1	



Controllers



Tap Timer

Faucet attached controller.

- Extra large readout screen and programming dial make it easy to set and review your watering schedules.
- In operation, the screen also displays program status such as next scheduled cycle and time remaining on a current cycle.
- Advanced features include programming up to two watering times per day on any day(s) of the week, plus “water now” and “cancel” buttons to override programs instantly when desired.
- 20mm female BSP threaded inlet and 20mm male BSP threaded outlet.
- Working water pressure: 1 - 6 bar.
- Flow range 2.7L/m - 36.7 l/min.
- Uses 2 x 1.5V AA alkaline batteries (not included).
- Three year warranty.



Description
Rain Bird Tap Timer - Battery Operated (AA) (ZA84006)

Inventory Code	Carton QTY	Min Order QTY
TAPTIMERRB	5	

ESP-9V Battery Operated Controller

- Waterproof case ensures long life, even when installed in a valve box. IP68 certified for protection against dust and water intrusion.
- Common programming features are easily accessed on one screen, making programming quick and easy.
- Operates for approximately one full year using one 9-volt alkaline battery, or two years with two 9-volt alkaline batteries.
- Large LCD display with easy to navigate user interface.
- Sensor input with bypass override.
- Master valve/pump-start circuit (multi-zone units only).
- Non-volatile (100-year) program memory.
- Plastic controller case has outstanding resistance to weather, yellowing and aging.
- Five year warranty.



Description
1-Station ESP-9V controller w/ DVF Valve & 9V latching coil (F48373)
ESP DC Battery Controller 9V 1 Station No Solenoid (ESP-9V)
ESP DC Battery Controller 9V 2 Stations No Solenoid (F48352)
ESP DC Battery Controller 9V 4 Stations No Solenoid (F48354)
ESP DC Battery Controller 9V 6 Stations No Solenoid (F48356)
WPX Wall Mount Bracket (F48340)

Inventory Code	Carton QTY	Min Order QTY
RBESP9VIDVFKIT	4	
RBESP-9V	6	
RBESP9VI2	6	
RBESP9VI4	6	
RBESP9VI6	6	
WPXWALL	5	

*indent only

ESP-BAT-BT Bluetooth Battery Operated Controller

The BAT-BT offers greater visibility and total command over sites with its unrivaled battery life, trouble-free installation, and streamlined operation via the Rain Bird mobile app.

- BAT-BT uses 4 x AA/LR6 batteries for an extended battery life of up to five years.
- Dedicated master valve/pump output on all station models.
- Run time is from 7 seconds to 9 hours (max 18 hours with 200% seasonal adjust) in 1 second increments.
- Independent programs A, B, C and D, with 8 start times per day
- Operates one valve per station and stations can be assigned to several programs with different watering run times.
- Direct Rain Sensor Connection accommodates the Rain Bird RSD-BEX Rain Sensor.
- Many more features making this controller the most feature rich Bluetooth battery-operated controller yet.
- 3 year warranty.



Description
ESP-BAT-BT Bluetooth 1 Station Battery Controller
ESP-BAT-BT Bluetooth 2 Station Battery Controller
ESP-BAT-BT Bluetooth 4 Station Battery Controller
ESP-BAT-BT Bluetooth 6 Station Battery Controller

Inventory Code	Carton QTY	Min Order QTY
ESPBATBT1	TBC	
ESPBATBT2	TBC	
ESPBATBT4	TBC	
ESPBATBT6	TBC	

(Available Mid 2024)

TBOS 2 Battery Operated Controller

Bluetooth Battery-Operated Controller. Install anywhere. Program from a Smartphone via Rain Bird app.

- Operates for approximately one full year using one 9-volt alkaline battery.
- Completely potted to obtain IP68 conformity.
- Independent station operation allows sequential start times (with stacking in case of overlap) restriction compliance.
- Master valve output on TBOS BT1, 2, 4, & 6 control modules.
- No loss of irrigation program after a battery replacement.
- Three year warranty.



Description
TBOS Bluetooth 1 Station Control Module (F48501B)
TBOS Bluetooth 2 Station Control Module (F48502B)
TBOS Bluetooth 4 Station Control Module (F48504B)
TBOS Bluetooth 6 Station Control Module (F48506B)

Inventory Code	Carton QTY	Min Order QTY
TBOS2CM1	6	
TBOS2CM2	6	
TBOS2CM4	6	
TBOS2CM6	6	



Irrigation



TM2 Series Controller

The ESP-TM2 irrigation controller is the perfect option for basic residential solutions. Building upon Rain Bird's legacy of The Intelligent Use of Water®, this controller offers simple water saving features that you will actually use.

With the flexibility of 3 programs and 4 start times available per program, you can tailor your watering schedule to your landscape's needs.

The ESP-TM2 provides the Extra Simple Programming interface you are familiar with in a controller that is built to last!

Best of all, you can upgrade the ESP-TM2 into a Wi-Fi-enabled controller by simply installing a new LNK WiFi Module, without having to replace the entire unit.

Make your controller SMART with EPA WaterSense certification by adding the LNK WiFi module and a WR2 rain sensor.

Features:

- ESP = Easy Simple Programming.
- Available in 4, 6, 8, and 12 station models
- Easy to install indoors or outdoors.
- Quick programming in just 3 steps for ease of setup.
- One-touch manual watering capability for ease of use
- Large back-lit LCD display for improved visibility in lowlight and direct sun conditions.



ESP-TM2 Irrigation Controller

Simplified

Residential / Light Commercial Controllers

RZX

- WiFi compatible with the Rain Bird LNK2 WiFi Module.
- Large LCD display with easy to navigate user interface shows all of the programming for each zone at the same time.
- Weather Sensor input with software override.
- Master valve/pump start circuit.
- Non-Volatile (100- year) program memory.
- Programmable under battery power.
- Three year warranty.



TM2

- WiFi compatible with the Rain Bird LNK2 WiFi Module.
- Easy to install indoors or outdoors.
- Quick programming in just 3 steps for ease of setup.
- One-touch manual watering capability for ease of use.
- Large back-lit LCD display for improved visibility in low-light and direct sun conditions.
- Contractor Default™ allows you to easily save and restore your custom schedule.
- Bypass Rain Sensor for any station gives you the ability to customize which stations react to a rain sensor.
- Three year warranty.



RC2

- 8 station, plug and play, Wifi based controller.
- Quick Pair technology for fast and seamless mobile connection.
- Rain Bird mobile app provides easy access to all program features.
- Three year warranty.



ME3

- The industry's most flexible irrigation controller solution. Supports up to 22 stations.
- Built-in flow-sensing capabilities.
- Large back-lit LCD display for improved visibility in low-light and direct sun conditions.
- Non-Volatile (100 year) storage memory.
- Remotely Programmable under 9V battery power (not included).
- WiFi compatible with the Rain Bird LNK2 WiFi Module.
- Three year warranty.



Description
ESP-RZX 4 Station Outdoor Controller (WiFi ready) (F55364)
ESP-RZX 6 Station Outdoor Controller (WiFi ready) (F55366)
ESP-RZX 8 Station Outdoor Controller (WiFi ready) (F55368)
ESP-TM2 4 Station Outdoor Controller (WiFi ready) (F54264)
ESP-TM2 6 Station Outdoor Controller (WiFi ready) (F54266)
ESP-TM2 8 Station Outdoor Controller (WiFi ready) (F54268)
ESP-TM2 12 Station Outdoor Controller (WiFi ready) (F54272)
RC2 8 Station WiFi Controller
ESP-Me3 Modular 4-22 Station Outdoor Controller (WiFi ready) (F55450)
Rain Bird ESP - ME 3 Station Expansion Module (F38200)
Rain Bird ESP - ME 6 Station Expansion Module (F38260)

Inventory Code	Carton QTY	Min Order QTY
RZX4-AUS	1	
RZX6-AUS	1	
RZX8-AUS	1	
ESP-TM2-4STN	6	
ESP-TM2-6STN	6	
ESP-TM2-8STN	4	
ESP-TM2-12STN	4	
RC2		
IESP4ME3AUS	4	
ESPSM3	12	
ESPSM6	10	

ESP-LXME Commercial Traditionally Wired Controllers

Quickly expand from 12 stations up to 48 stations using 12 station modules.

- Large LCD display with easy to navigate softkey user interface.
- Hot-swappable modules, no need to power down the controller to add/remove modules.
- 2 x master valve/pump start circuits.
- Program memory retention without power or battery in non-volatile memory.
- Standard 10kV surge protection.
- Front panel is removable and programmable under battery power.
- Pro Smart Module™ with Learn Flow utility and flow usage totaliser.
- FloWatch™ protection for high and low flow conditions with user defined reactions.
- FloManager™ manages hydraulic demand, making full use of available water to shorten total watering time.
- Station run timing: up to 96 hrs continuous runtime.
- Seasonal Adjust: 0% to 300% (16 hrs maximum station run time).
- 40 independent programs, programs can overlap.
- 10 start times per program.
- See controller specification sheet for more features.
- Three year warranty.



Description
ESP-LXME2 12 Station Modular Controller
ESP-LXME2PRO 12 Station Modular Controller (with Flow Input)
Rain Bird ESP - LXM8 Station Expansion Module (F42210)
Rain Bird ESP - LXM12 Station Expansion Module (F42220)
Rain Bird ESP - LXME Flow Smart Module (F45000)
Pro-Smart Module for LXME2 (Flow Input and 2nd Master Valve)
ESP-LXME2 Front Panel Only
ESP-2WIRE (Coming Soon)

Inventory Code	Carton QTY	Min Order QTY
*IESPLXME2AU	1	1
IESPLXME2PAU	1	
ESPLXMSM8	12	
ESPLXMSM12	6	
FSMLXME	1	
PSMLXME2	1	
LXME2-FP	1	

ESP-2WIRE Controller

An entry-level, easy to use 2 wire irrigation controller for residential and light commercial applications that will accommodate up to 50 stations.

- Compatible with standard direct burial irrigation wire and standard irrigation wire connectors.
- Decoder Auto-Address to detect and assign decoder addresses to stations.
- Rain sensor input with bypass capability.
- Supports up to two 2-wire paths.
- 4 available programs with up to 6 start times for each program.
- Diagnostic LEDs on the back plane and on each 2W-1 Decoder for advanced troubleshooting.
- After decoders are programmed, the ESP-2WIRE Controller programs just like the popular ESP-ME3 Controller.
- 3 year warranty.



Description
ESP-2WIRE 50 Station Decoder Controller
ESP-2WIRE Single Station Decoder

Inventory Code	Carton QTY	Min Order QTY
ESP2WIRE	TBC	
ESP2WIRE-DEC	TBC	

(Available Mid 2024)

ESP-LXD Commercial 2 Wire Decoder Controllers

50 – 200 station capable Two-Wire Decoder Commercial Controller.

- 50-station capability standard expandable to 200 stations with optional ESPLXD-SM75 modules.
- Four available sensor inputs (one wired plus up to three decoder managed) with override switch.
- Up to five flow sensors supported.
- Supported decoders: FD-101TURF, FD-102TURF, FD-202TURF, FD-401TURF, FD-601TURF.
- Removable front panel is programmable under battery power.
- Station timing: 0 min to 12 hrs.
- Program level and global Monthly Seasonal Adjust; 0% to 300% (16 hrs maximum station run time).
- 4 independent programs (ABCD); ABC programs stack, ABCD overlap.
- 8 start times per program.
- Three year warranty.



Description
ESP-LXD 50 Station Modular to 200 Station, 2 Wire Decoder, Outdoor Controller (F43130)
Rain Bird ESP - LXD 75 Station Expansion Module (F43150)
FD-101 Decoder - 1 Address, 1 Solenoid per Address (D16250)
FD-102 Decoder - 1 Address, 2 Solenoid per Address (D16300)
FD-202 Decoder - 2 Addresses, 2 Solenoids per Address (D18600)
FD-401 Decoder - 4 Addresses, 1 Solenoid per Address (D18610)
FD-601 Decoder - 6 Addresses, 1 Solenoid per Address (D18000)
PD-210 Pump Decoder (D16500)
SD211 Sensor Decoder (D18711) - no surge protection
Sensor Decoder for switch sensors (M51300)
Line Surge Protector (D16350)

Inventory Code	Carton QTY	Min Order QTY
IESPLXDA	1	
ESPLXD75	1	
FD-101	1	
FD-102	1	
FD-202	1	
FD-401	1	
FD-601	1	
PD210	1	
SD211	1	
DECSENLR	1	
LSP-1	1	

ESP-LX-IVM Commercial Controllers

60/240 Station Capable Two-Wire Commercial Controller.

- Four available sensor inputs (one wired plus up to three on 2-Wire path) with override switch. Eight (Seven plus 1) for LX-IVM Pro.
- Five flow sensors supported (LX-IVM), Ten for LX-IVM Pro.
- Supported Field devices: IVM-SOL, IVM-OUT, IVM-SD, and IVM Smart Valves.
- Supports IVM-SEN sensor devices (flow sensing and weather sensor support) and IVM-SD surge devices.
- 10 independent programs (LX-IVM) or 40 Programs (LX-IVM Pro).
- Removable front panel is programmable under battery power.
- Station timing: 0 min to 96 hrs.
- Program level and global Monthly Seasonal Adjust; 0% to 300% (96 hrs maximum station run time).
- 8 start times per program.
- Three year warranty.



IVM-SOL

- Interfaces with LX-IVM to control station valves and master valves.
- Interfaces with PEB, PESB, PGA, EFB-BP and BESP Valves.
- Available pre-installed in a SmartValve configuration with PEB and PGA Valves.
- Three year warranty.



IVM-OUT

- Interfaces with LX-IVM to manage 3rd party valves (with latching solenoids) and external gear such as pump stations.
- Three year warranty.

IVM-SEN

- Interfaces with LX-IVM to control weather sensors or flow sensors.
- Three year warranty.



IVM-SD (Surge Protection)

- IVM-SD provides surge protection on the 2-Wire path.
- One every 150m or 15 field devices.
- Three year warranty.

Description
ESP-LXIVM 60 Station, 2 Wire Smart Valve Controller, Outdoor Controller (F46130)
ESP-LXIVM 240 Station, 2 Wire Smart Valve Controller, Outdoor Controller (F46135)
ESP-LXIVM 2 Wire Solenoid (F47100)
ESP-LXIVM 2 Wire Output Device (F47120)
ESP-LXIVM 2 Wire Sensor Device (F47110)
ESP-LXIVM 2 Wire Surge Device (F47125)

Inventory Code	Carton QTY	Min Order QTY
ILXIVMAU	1	
ILXIVMPAU	1	
LXIVMSOL	6	
LXIVMOUT	5	
LXIVMSEN	5	
LXIVMSD	12	



Remote

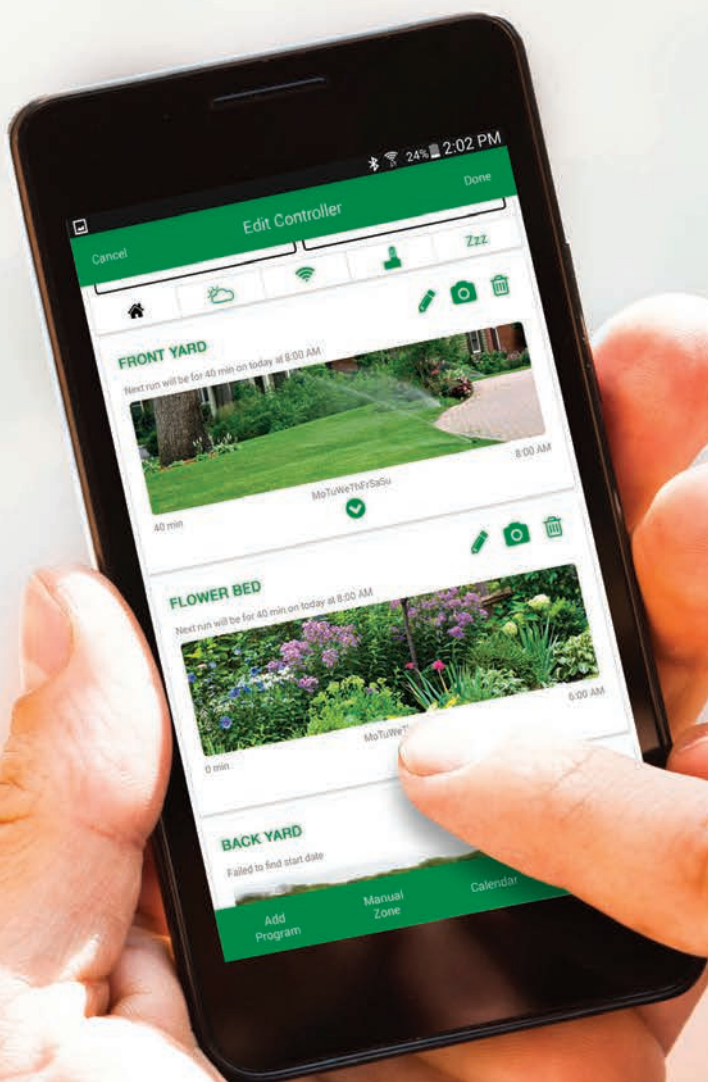

LNK2 WiFi Module

The Rain Bird LNK WiFi Module allows easy access and control of a Rain Bird irrigation system from anywhere in the world. With the LNK WiFi Module and Rain Bird's FREE mobile app, users get access to off-site management, real-time alerts and advanced water management tools via their smart phone or tablet.

Features:

- Upgrades WiFi-ready controllers to make them fully accessible from your mobile device.
- Simple to use mobile app interface gives you access from anywhere in the world.
- Operates like a wireless remote control for your irrigation system while onsite or an internet-based monitoring and control system when offsite.
- Streamlines and simplifies initial irrigation timer setup and seasonal adjustment.
- Built-in mobile notifications provide troubleshooting access, simplify service calls, and warn of freezing conditions when expected.
- Automatic weather adjustments provide daily run time changes, saving up to 50% in water.



RBf55002

Control

Controller Accessories/ Other Controllers

LNK2 WiFi Module

- Irrigation system control from anywhere.
- Upgrades WiFi-ready controllers to make them fully accessible and programmable from iOS 8.0 and Android 6 (or later) compatible devices.
- Operates like a wireless remote control for your irrigation system while onsite or an internet-based monitoring and control system when offsite.
- Streamlines and simplifies initial irrigation timer setup and seasonal adjustment.
- Compatible professional app features allow for simple multi-site management and remote diagnostics by landscape professionals.
- Built-in mobile notifications provide troubleshooting access, simplify service calls, and warn of freezing conditions when expected.
- Automatic weather adjustments provide daily run time changes, saving up to 50% in water.
- Three year warranty.

IQ NCC-RS RS232 Cartridge

- Includes RS-232 Port for IQ Direct Cable or external Modem communication connection to the IQ central computer, and external modem cable (IQ Direct Cable provided with IQ Software Package).
- Used for Direct or Server Satellite applications requiring direct cable connection or external modem (radio or other 3rd-party device) communication with the IQ central computer, and for Client.
- Satellite applications requiring IQNet high-speed data cable or radio communication with the Server Satellite.
- Three year warranty.

IQ NCC-EN Ethernet Cartridge

- Includes embedded Ethernet Network Modem with RJ-45 port.
- Includes RJ-45e patch cable (requires LAN network static IP address).
- Three year warranty.

IQ NCC 3G/4G Cellular Cartridge

- Includes embedded Cellular Data Modem with antenna connector.
- Includes internal antenna for plastic controller enclosures.
- Requires cellular data service plan purchased from Rain Bird with cellular service included.
- Used for direct or server satellite applications requiring wireless cellular communication with the IQ central computer.
- Available with 1st year of communication service included.
- Three year warranty.



Description
LNK Wifi Module (F55002)
Maxi Grounding Plate (D05400)
Maxi Surge Pipe (D05110)
Grounding Rods with Clamps (GR1324AU)
Grounding Rods with Clamps - 1 package with 10 rods (GR1324AUP)
IQ RS-232 NCC for LXME/LXD Controllers (IQ4600)
IQ Ethernet NCC for LXME/LXD Controllers (IQ4603)
IQ 3G NCC for LXME/LXD Controllers - with Sim Card/12 months data (IQ4613)
IQ 4G NCC for LXME/LXD Controllers - with Sim Card/12 months data (IQ4614A)
IQ Client/Server & Flow Smart Module for LXD (IQ4621)
IQ Client/Server & Flow Smart Module for LXME/F (IQ4622)
IQ External Antenna Kit (IQ4640)
Transformer - Large Decoder Interface (24V-75VA)
Large Decoder Interface without Transformer (H50210)
PT322 Pulse Transmitter - programmable by laptop, no transformer (M80201)
PT3002 Pulse Transmitter - with display, no transformer (M80206)

Inventory Code	Carton QTY	Min Order QTY
RBF55002	5	
MGP1	1	
MSP1	1	
GR1324AU	1	
GR1324AUP	10	
*IQ4600	1	1
IQ4603	1	
IQ4613	1	
IQ4614	1	
IQ4621	1	
IQ4622	1	
IQ4640	1	
RB24V-75VA	1	
RBH50210	1	
*RBM80201	1	1
*RBM80206	1	1

Sensors and Weather Stations

RSDBEX - Hard Wired Rain Sensor

- Robust, reliable design reduces service call backs.
- Moisture sensing disks work in a variety of climates.
- Different sensor mounts permit speed and flexibility on the job site.
- Latching hinge maintains alignment.
- Multiple rainfall settings from 5 - 20 mm are quick and easy with just the twist of a dial.
- Adjustable vent ring helps control drying time.
- High-grade, UV resistant polymer body resists the elements.
- Three year warranty.

WR2-RC - Wireless Rain Sensor

- Enhanced antenna array provides superior signal reliability that overcomes most line-of-sight obstructions.
- Sensor signal strength indicator enables one person set up, reducing installation time.
- Convenient adjustment and monitoring of rain or freeze settings at the controller interface.
- Highly intuitive icon-driven controller interface simplifies programming.
- Easy to install, self-leveling sensor bracket mounts to flat surfaces or rain gutters.
- 'Quick Shut Off' interrupts active irrigation cycle during a rain event.
- Signal transmission distance of 213.4 m Line of Sight.
- Battery life: four or more years under normal operating conditions.
- Three year warranty.

RBA65022 - Soil Moisture Sensor (SMRT-Y)

- Turns any controller into a water saving smart controller.
- Typical water savings exceed 40%.
- TDT digital sensor enables highly accurate readings that are independent of soil temperature and electrical conductivity (EC).
- Displays soil moisture content, soil temperature and EC.
- Corrosion-resistant in-ground sensor made of high-grade 304 stainless steel.
- Three year warranty.

Weather Station

- Scientific accuracy sensors located three meters above the ground for added vandal-resistance.
- Air Temperature, Solar Radiation, Relative Humidity, Wind Speed, Wind Direction and Rainfall Sensors.
- Three year warranty.

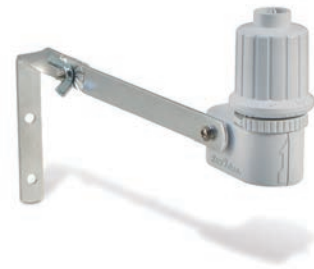

Description
Bracket Mount, Hard Wired Rain Sensor (A61200)
Wireless Rain Sensor (A553400)
Soil Moisture Sensor (A65020)
100mm Rainfall Gauge (M61010)
Wind Speed Sensor - Anemometer (M80302)
WS PRO 2 Weather Station - Phone (H59902)
WS PRO 2 Weather Station - Hardwire/Direct Connect (H59907)
WS PRO 2 Weather Station - Hardwire/Direct Connect - Solar (H59917)

Inventory Code	Carton QTY	Min Order QTY
RSDBEX	1	
WR2-RC	1	
RBA65022	1	
RBM61010	1	
*RBM80302	1	
*H59902	1	1
*H59907	1	
*H59917	1	

*indent only

Flow Sensors

FS Series

- Simple six-bladed impeller design.
- Designed for outdoor or underground applications.
- Pre-installed in tee or saddle mounted insert versions.
- Accuracy: +- 1% (full scale).
- Velocity: 0.15 - 9.2 meters per second depending on model.
- Pressure: 400 psi (27.5 bars) (max) on brass models; 100 psi (6.9 bars) (max) on plastic models.
- Three year warranty.



Description
25mm Flow Sensor (ST-ELF-T10-N02)
FG100 1" Flow Sensor BSP
40mm PVC Tee Flow Sensor - Female BSP (M80115)
50mm PVC Tee Flow Sensor - Female BSP (M80116)
100mm PVC Tee Flow Sensor - Flanged (M80118)
FS350B - Brass Insert Flow Sensor - 2"NPT (M80105)

Inventory Code	Carton QTY	Min Order QTY
ST-ELF-T10-N02	1	
RBF100	1	
FSM80115	1	
FSM80116	1	
FSM80118	1	
FSM80105	1	

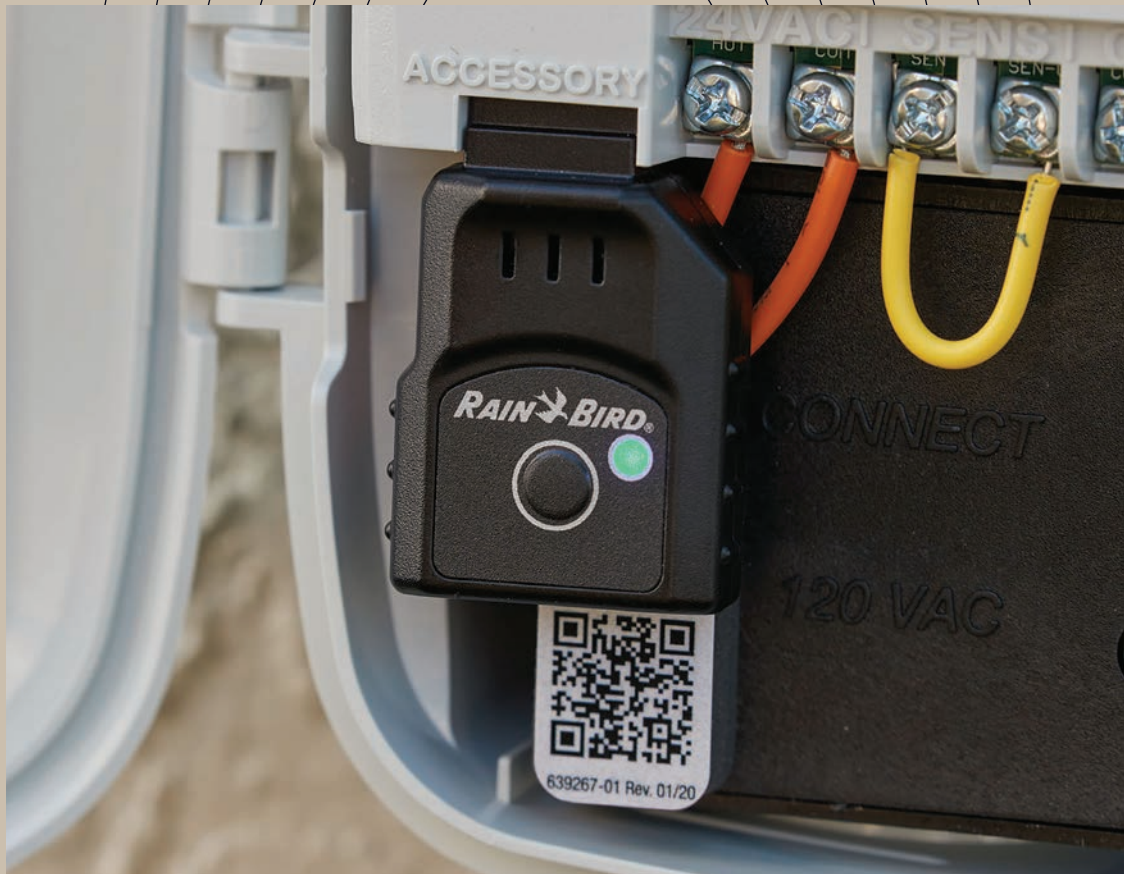



Cable and Cable Accessories

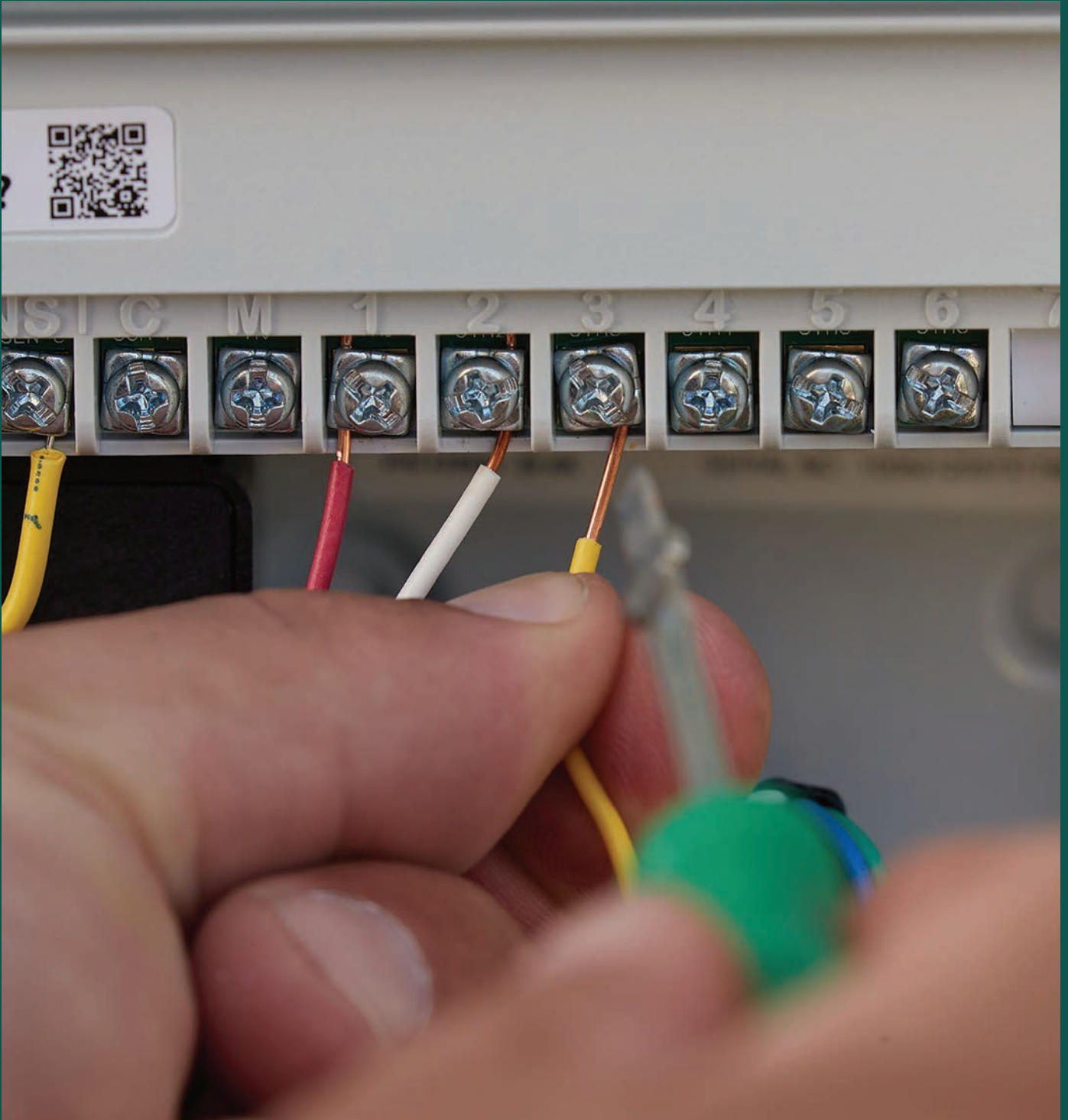

Wire - Maxi Cable

- Double-jacketed with solid copper wire and is non-twisted for reliable communication.
- Rated for direct burial.
- Comes in several colours which can be useful when troubleshooting if you use a different colour for each separate wire path.
- Tin coated, soft drawn bare copper.
- Insulation: Polyvinylchloride (PVC)
- Outer Jacket: Polyethylene (PE)
- Temperature: 60 C
- Voltage: 600 volts



Description
Maxi Cable - 2 Core x 2.5mm x 100m - Blue (WWS21178Blue100)
Maxi Cable - 2 Core x 2.5mm x 100m - Green (WWS21178Green100)
Maxi Cable - 2 Core x 2.5mm x 100m - Red (WWS21178Red100)
Maxi Cable - 2 Core x 2.5mm x 100m - Yellow (WWS21178Yellow100)
Maxi Cable - 2 Core x 2.5mm x 500m - Blue (WWS21178Blue)
Maxi Cable - 2 Core x 2.5mm x 500m - Green (WWS21178Green)
Maxi Cable - 2 Core x 2.5mm x 500m - Red (WWS21178Red)
Maxi Cable - 2 Core x 2.5mm x 500m - Yellow (WWS21178Yellow)

Inventory Code	Carton QTY	Min Order QTY
*MAXI100B	1	
*MAXI100G	1	
MAXI100R	1	
*MAXI100Y	1	
*MAXI500B	1	
*MAXI500G	1	
MAXI500RED	1	
*MAXI500Y	1	

Wire - Single Core

- PP Insulated, PVC Sheathed.
- Multi strand plain copper Conductor to AS1125.
- PP UV Stabilised.



Description
1.5mm x 100m Single Core Irrigation Cable - Black (SCW15-100B)
1.5mm x 500m Single Core Irrigation Cable - Black (SCW15-500BL)
1.5mm x 500m Single Core Irrigation Cable - Dark Green (SCW15-500DG)
1.5mm x 500m Single Core Irrigation Cable - Red (SCW15-500R)
1.5mm x 500m Single Core Irrigation Cable - Yellow (SCW15-500Y)
2.5mm x 500m Single Core Irrigation Cable - Black (SCW25-500BL)
2.5mm x 500m Single Core Irrigation Cable - Dark Green (SCW25-500DG)
2.5mm x 500m Single Core Irrigation Cable - Red (SCW25-500R)

Inventory Code	Carton QTY	Min Order QTY
*IWP15-100B	1	
*IWP15-500BLK	1	
*IWP15-500DG	1	
IWP15-500R	1	
*IWP15-500Y	1	
IWP25-500BL	1	
*IWP25-500DG	1	
*IWP25-500RED	1	

Wire - Multi Core

- PP insulated, PVC sheathed.
- Multi strand plain copper conductor to AS1125.
- PP UV stabilised.



Description	Inventory Code	Carton QTY	Min Order QTY
2 Core x 1.0mm x 100m Irrigation Cable - Red (MCW210-100)	MCP210-100	1	
2 Core x 1.0mm x 500m Irrigation Cable - Red (MCW210-500)	*MCP210-500	1	
2 Core x 1.5mm x 100m Irrigation Cable - Red (MCW215-100)	MCP215-100	1	
2 Core x 1.5mm x 500m Irrigation Cable - Red (MCW215-500)	MCP215-500	1	
2 Core x 2.5mm x 100m Irrigation Cable - Red (MCW225-100)	MCP225-100	1	
2 Core x 2.5mm x 500m Irrigation Cable - Red (MCW225-500)	MCP225-500	1	
3 Core x 0.5mm x 50m Irrigation Cable - Red (MCW35-50)	MCP35-50	1	
3 Core x 0.5mm x 100m Irrigation Cable - Red (MCW35-100)	MCP35-100	1	
3 Core x 1.5mm x 100m Irrigation Cable - Red (MCW315-100)	MCP315-100	1	
3 Core x 2.5mm x 100m Irrigation Cable - Red (MCW325-100)	*MCP325-100	1	
5 Core x 0.5mm x 50m Irrigation Cable - Red (MCW55-50)	MCP55-50	1	
5 Core x 0.5mm x 100m Irrigation Cable - Red (MCW55-100)	MCP55-100	1	
5 Core x 1.0mm x 100m Irrigation Cable - Red (MCW510-100)	MCP510-100	1	
5 Core x 1.0mm x 500m Irrigation Cable - Red (MCW510-500)	*MCP510-500	1	
5 Core x 1.5mm x 100m Irrigation Cable - Red (MCW515-100)	MCP515-100	1	
5 Core x 1.5mm x 500m Irrigation Cable - Red (MCW515-500)	MCP515-500	1	
5 Core x 2.5mm x 100m Irrigation Cable - Red (MCW525-100)	*MCP525-100	1	
5 Core x 2.5mm x 500m Irrigation Cable - Red (MCW525-500)	*MCP525-500	1	
7 Core x 0.5mm x 50m Irrigation Cable - Red (MCW75-50)	MCP75-50	1	
7 Core x 0.5mm x 100m Irrigation Cable - Red (MCW75-100)	MCP75-100	1	
7 Core x 0.5mm x 500m Irrigation Cable - Red (MCW75-500)	*MCP75-500	1	
7 Core x 1.0mm x 100m Irrigation Cable - Red (MCW710-100)	MCP710-100	1	
7 Core x 1.0mm x 500m Irrigation Cable - Red (MCW710-500)	*MCP710-500	1	
7 Core x 1.5mm x 100m Irrigation Cable - Red (MCW715-100)	MCP715-100	1	
7 Core x 1.5mm x 500m Irrigation Cable - Red (MCW715-500)	MCP715-500	1	
7 Core x 2.5mm x 100m Irrigation Cable - Red (MCW725-100)	*MCP725-100	1	
9 Core x 0.5mm x 50m Irrigation Cable - Red (MCW95-50)	MCP95-50	1	
9 Core x 0.5mm x 100m Irrigation Cable - Red (MCW95-100)	MCP95-100	1	
9 Core x 1.0mm x 100m Irrigation Cable - Red (MCW910-100)	*MCP910-100	1	
9 Core x 1.0mm x 500m Irrigation Cable - Red (MCW910-500)	*MCP910-500	1	
9 Core x 1.5mm x 100m Irrigation Cable - Red (MCW915-100)	MCP915-100	1	
9 Core x 1.5mm x 500m Irrigation Cable - Red (MCW915-500)	MCP915-500	1	
13 Core x 0.5mm x 100m Irrigation Cable - Red (MCW135-100)	MCP135-100	1	
13 Core x 1.0mm x 100m Irrigation Cable - Red (MCW1310-100)	*MCP1310-100	1	
13 Core x 1.0mm x 500m Irrigation Cable - Red (MCW1310-500)	*MCP1310-500	1	
13 Core x 1.5mm x 100m Irrigation Cable - Red (MCW1315-100)	MCP1315-100	1	
13 Core x 1.5mm x 500m Irrigation Cable - Red (MCW1315-500)	MCP1315-500	1	

Wire - Cable Connectors

3M-RANGE

- Suitable for joins up to 600VAC.
- Mineral Oil Base EG-3 Grease.
- Flame retardant.
- Maximum Operating Temperature 105°.
- Maximum Recommended Voltage Rating 600 V.
- 314 - For use with 0.5 to 1.5mm² cable.
- DBO/B - For use with 0.75 to 2.5mm² cable.
- DBR/Y - For use with 1.0 to 6.0mm² cable.



DBRY20 - RAINBIRD WC20

- Wire combinations ranging from 0.3 to 8.4mm².
- Use on connections from 24 VAC to 600 VAC.
- UL 486D certified for direct burial.
- The Strain Relief ensures wires are secure and won't pull apart.
- Waterproof silicone sealant protects against corrosion.
- UV-resistant material ensures product performance does not degrade even after long periods of exposure to sunlight.

Description
314 Scotchlok Electrical Connector (each - sold in bags 50)
Direct Bury Splice Kit DBO/B-6 100/CTN
Direct Bury Splice Kit DBR/Y-6 100/CTN
DB Red/Yellow Wire Connector 600V - Bag of 20 (WC20)

Inventory Code	Carton QTY	Min Order QTY
3M-314	50	50
3M-DBO/B	100	100
3M-DBR/Y	100	100
DBRY20	20	20

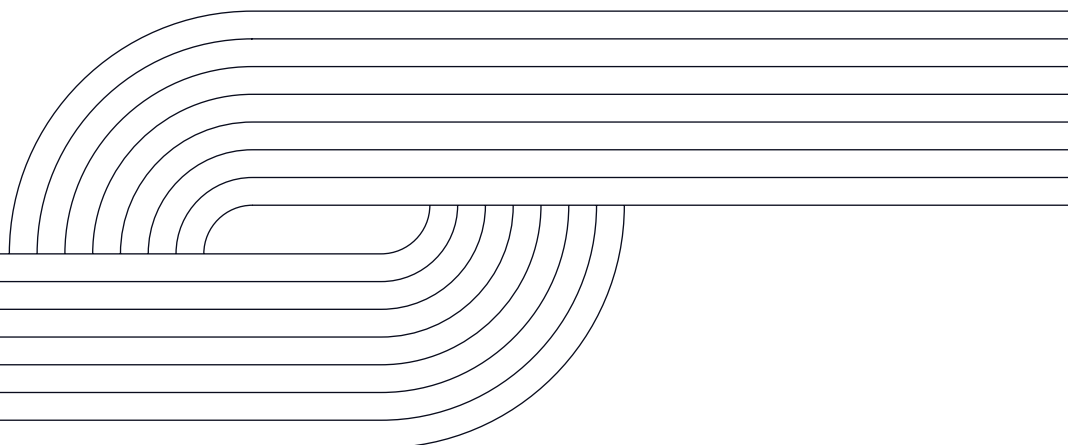



Drip / Micro Irrigation



Drippers

Drip System Operation Indicator

- Stem rises 15.2cm for clear visibility.
- When stem is extended, drip system is charged to a minimum of 1.38 bar.
- Operational Indicator Kit includes three different indication caps: potable, nonpotable, or an adjustable 4-VAN spray nozzle.
- Includes 40.6cm of 1/4" distribution tubing with connection fitting pre-installed.

Xeri-Bug™ Emitters

- A pressure-compensating design offers a consistent flow from 1.0 to 3.5 bar from the first emitter in the line to the last.
- A self-flushing action cleans the emitters every time the system turns on and off, reducing maintenance and extending the life of the emitter.
- Self-piercing models feature barbs that make installation easier.
- Robust design made from UV-resistant materials that are also resistant to chemicals.
- Colour-coded to identify flow rate.

Xeri-Bird™ 8-Outlet Emission Device

- The most flexible and feature-rich multi-outlet device on the market. Ideal for new projects and retrofit applications.
- The only multi-outlet device on the market with 8 configurable ports and 10 flow options for each port for maximum flexibility.
- Easy to maintain, because body can be easily removed from riser.
- Threads onto any 1/2" riser and delivers water to multiple locations for increased system flexibility.
- Eight bottom-mounted, sure-grip barbed outlets securely retain 6 mm Distribution Tubing.
- Unique union base nut allows removal of Xeri-Bird 8 body from riser for easy installation and maintenance.
- Emitters must be installed inside the Xeri-Bird to prevent excess back pressure.
- Pressure: 1.0 to 3.5 bar.
- One year warranty.



Description
Drip System Operational Indicator (X17500)
XERI Bug Emitter PC - 1.96 L/Hr (X68030)
XERI Bug Emitter PC - 3.8 L/Hr (X68040)
XERI Bug Emitter PC - 7.6 L/Hr (X68050)
XERI-BIRD With Emitters

Inventory Code	Carton QTY	Min Order QTY
RBX17500	1	
XB05PC	25	
XB10PC	25	
XB20PC	25	
RBX61000	1	

Micro-Quick Sprinklers

- No tools required for assembly, disassembly, or maintenance with easy snap fit nozzles and deflectors.
- All sprinkler spray patterns are aligned and fixed in position to the stake. Stake does not wilt or twist, even in the harshest environments.
- Colour-coded nozzles for easy identification.
- Constructed with Ultraviolet (UV) stabilised resin to protect from sun damage and chemicals.
- Operates in both an upright or inverted installation.
- Operational pressure range 0.69 to 2.07 bar.
- One year warranty.



Description
Micro-Quick Spray - 12 GPH - DC Pattern (Green) (MQBS36DC12)
Micro-Quick Spray - 14 GPH - DC Pattern (Purple) (MQBS36DC14)
Micro-Quick Dual Pattern Deflector (DC Pattern) (Q10900DC)
Micro-Quick Nozzle - 18.9l/h (Black) (Q1080005)
Micro-Quick Nozzle - 30.3l/h (Orange) (Q1080008)
Micro-Quick Nozzle - 45.4l/h (Blue) (Q1080012)
Micro-Quick Nozzle - 53l/h (Violet) (Q1080014)
Micro-Quick Nozzle - 64.4l/h (Green) (Q1080017)
Micro-Quick Nozzle - 90.9l/h (Red) (Q1080024)
Micro-Quick Nozzle - 124.9l/h (White) (Q1080033)

Inventory Code	Carton QTY	Min Order QTY
MQBS36DC12	400	
MQBS36DC14	400	
RBMQ10900DC	3000	
RBMQ1080005	5000	
RBMQ1080008	5000	
RBMQ1080012	5000	
RBMQ1080014	5000	
RBMQ1080017	5000	
RBMQ1080024	5000	
RBMQ1080033	5000	

SQ Series

Square Pattern Nozzles - Precise and efficient, low-volume spray nozzle for irrigation around the perimeter of trees or shrubs.

- Square spray pattern and pressure compensation offer increased efficiency and control, reducing overspray, property damage, and liability.
- Can be installed on a variety of spray heads and risers.
- With a simple turn of the nozzle to the next preset stop, the Rain Bird SQ Nozzle adjusts from a 0.8 m throw to a 1.2 m throw.
- Pressure: 1.4 to 3.5 bar.
- Three year warranty.



Description
Square Nozzle Full Circle - PC
Square Nozzle Three Quarter Circle - PC
Square Nozzle Half Circle - PC
Square Nozzle Quarter Circle - PC
SQ Poly Flex Riser Adaptor
SQ Poly Flex Riser Adaptor Assembly
SQ Poly Flex Riser Stake Assembly

Inventory Code	Carton QTY	Min Order QTY
RBX54900	100	
RBX54907	100	
RBX54901	100	
RBX54902	100	
RBX54903	200	
RBX56200	200	
RBX56500	250	

Root Watering System

- Subsurface aeration and irrigation prevents tree and shrub transplant shock.
- Highest efficiency solution for tree irrigation - up to 95% emission uniformity with minimal wind, evaporation, or edge control losses.
- Aesthetically designed subsurface bubbler contributes to a landscape's natural appearance.
- Locking grate at grade deters vandals.
- Helps prevent shallow root growth and hardscape damage.
- Aesthetically attractive below grade installation.
- Self-contained and factory assembled units for assured reliability.
- Three year warranty.



Description
Root Watering Sand Sock
Root Watering System - 900mm Long Basket - 2lph PC Bubbler
Root Watering System - 450mm Long Basket - 2lph PC Bubbler
Root Watering System - 200mm Long Basket - 2lph PC Bubbler

Inventory Code	Carton QTY	Min Order QTY
RBA22435	48	
RBA22450	6	
RBA22475	12	
RBA22490	20	

Metzer Dripline

Effluent - Purple

- 2.1 L/hr x 0.6mm spacing.
- 16mm ID tube with 0.9mm thickness.
- Excellent field performance under harsh conditions.
- Highly durable and reliable structure.
- Large clog-resistant inlet filter.
- Wide range of working pressures for various topographies.

Landscape - Brown

- 2.1 L/h x 0.3mm spacing.
- 13mm ID tube with 0.9mm wall thickness.
- Unique and accurate regulating labyrinth mechanism.
- Suitable for different water sources and quality.
- Long-lasting silicon diaphragm.



Description
Metzer Purple Wastewater Drip tube with Vered Dripper 2.1 l/h x 0.6m x 16mm x 0.9mm x 100m
Metzer Brown Irrigation Drip tube with Assif Dripper 2.1 l/h x 0.3m x 13mm x 0.9mm x 100m

Inventory Code	Carton QTY	Min Order QTY
NZS-01-PURPLE	1	
NZS-03-BROWN	1	

Dripline/Lateral Staples and Cobra Clamps

Staples

- Galvanised Wire pins/staples; For pipe up to 30mm OD.
- Rounded top to help prevent pinching of thin walled pipe.
- Can also be used as weedmat pins.
- 2 sizes available: 230mm (9") and 130mm (5") long.
- Box of 200.

Cobra Clips

- 304 Stainless Steel band.
- Low profile closure with self- adjusting diameter.
- Quick, easy and safe installation.
- C15/8 - for 13mm lateral and dripline pipe.
- C22/8 - for 19mm lateral pipe.
- C28/8 - for 25mm lateral pipe.
- NB: Many other sizes also available.



Description
5" Galvanised Hose Staple - Box of 200 pcs (FP-HS130B)
9" Galvanised Hose Staples - Box of 200 pcs (FP-HS230B)
W4, COBRA, IRRIGATION CLAMP, 15.5-17.0MM Ø, 8.0MM WIDE
W4, COBRA, IRRIGATION CLAMP, 22.5-24.0MM Ø, 8.0MM WIDE
W4, COBRA, IRRIGATION CLAMP, 28.5-30.0MM Ø, 8.0MM WIDE

Inventory Code	Carton QTY	Min Order QTY
GHS130	200	1
GHS230	200	1
C15/8	100	100
C22/8	100	100
C28/8	100	100

Dripline/Lateral Tools

Tube Cutter

- Designed for easy and clean cutting of all distribution tubing used in low volume irrigation installations.

Xeriman Hole Punch

- All-in-one tool inserts emitters, removes emitters, inserts 1/4" barbed fittings and installs goof plugs.



Description
Tube Cutter with SS Blade (13-16mm & 3-5mm Tube) (X82100)
XERIMAN Hole Punch Tool (X80100)

Inventory Code	Carton QTY	Min Order QTY
PPC200X	1	1
XMTOOL	1	1

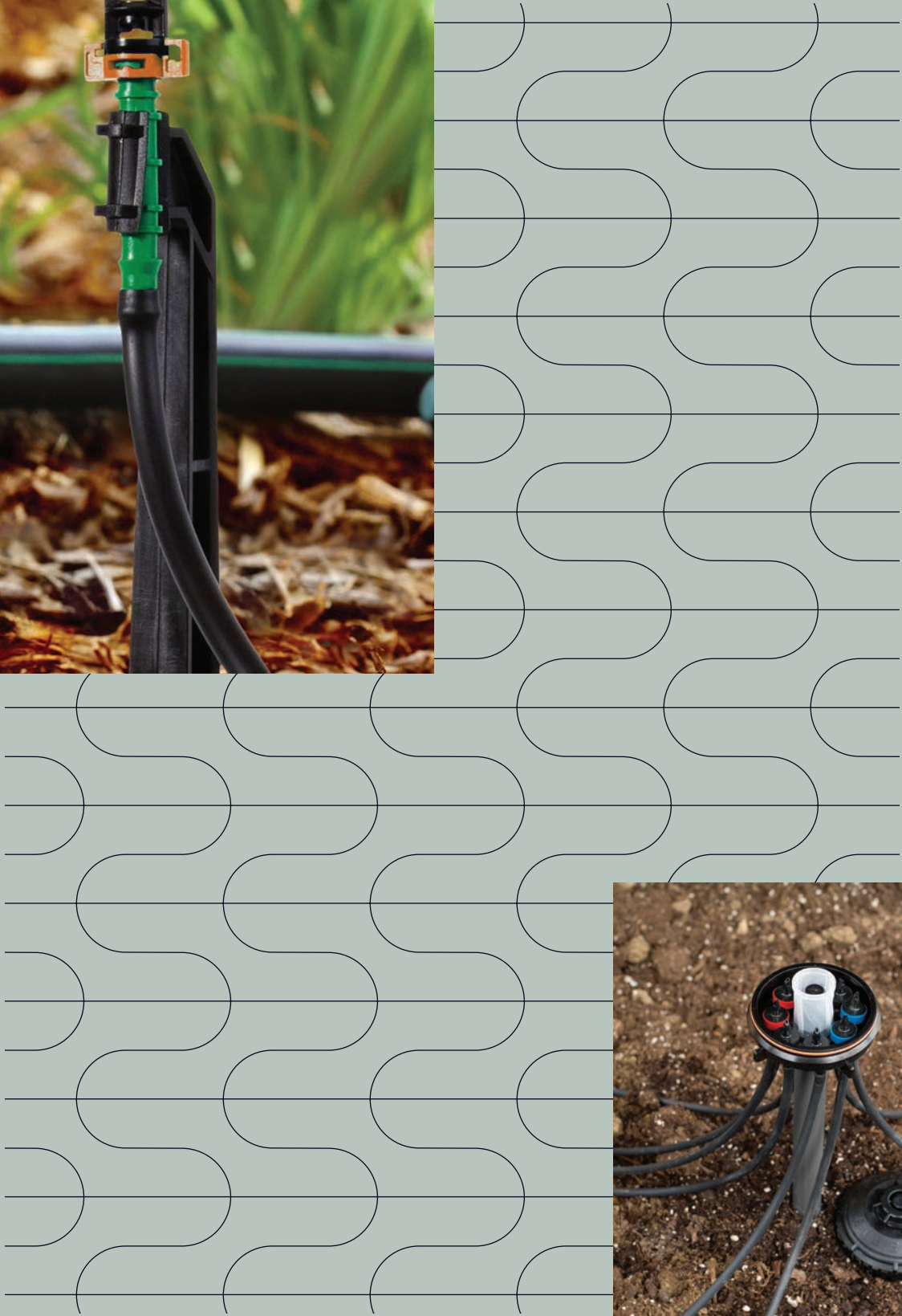

Why choose our products?

Our products were especially selected for their water saving features.

The very best advice from our technical team.

Peace of mind that your product is covered by warranty.

Our products offer quality, performance and reliability.

Automatic Irrigation for a Beautiful Landscape with confidence.

An automatic irrigation system with a controlled water intake system allows you to:



Enjoy your spare time

While your automatic watering takes care of your lawn and garden.



Save water

Programmable controllers can apply water at night when evaporation is low.



Maintain the health of your landscape

By regular and controlled water supply.



Save money

Plants are watered according to their needs, without excess.



Have peace of mind

Enjoy your holiday knowing your lawn and garden are automatically maintained.



Protect the environment

Our Irrigation products are designed to use water as efficiently as possible.

Guaranteed Water Savings

Controllers automatically monitor irrigation cycles, and sensors contribute to water savings by preventing irrigation systems from watering in the rain. Adding such devices can result in 25% or more in water savings.

These water savings will be achieved with a properly designed irrigation system, proper installation and regular system maintenance.

Tranquility for your garden, in agreement with the planet!

To be successful, your installation needs efficient and durable products. Our comprehensive Irrigation range offers quality products including: spray heads, rotors, valves, 230V or battery-operated controllers, landscape drip fittings, accessories, and more!

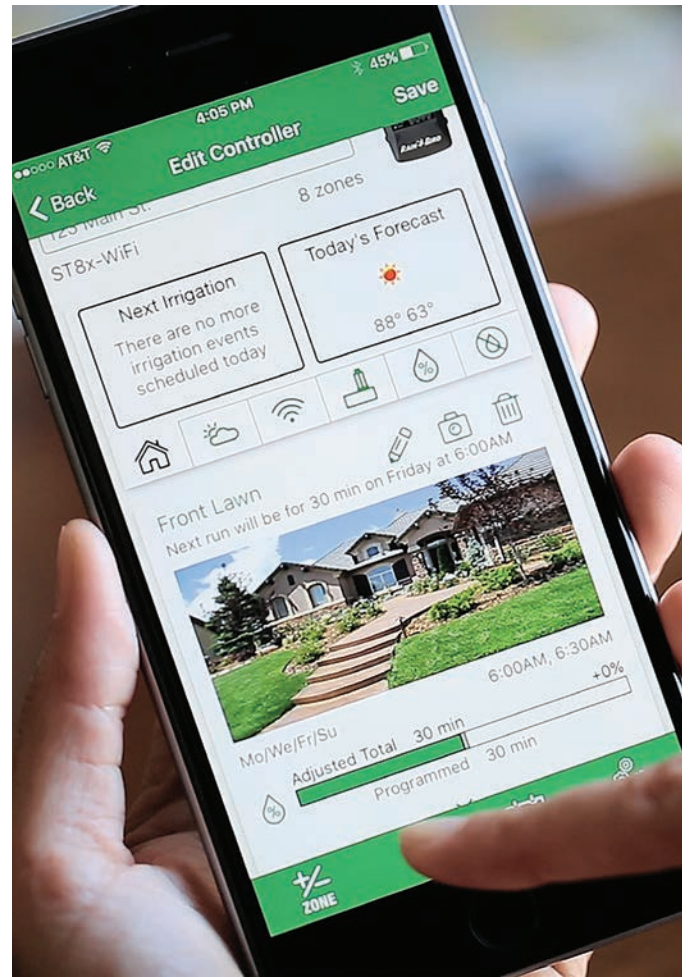

Intelligent,
efficient &
convenient
automation.



Do it Yourself Design Guide

Information Required for Design

-
- A scale plan/drawing of your property.
 - Power supply location and controller preference.
-
- What you are wanting watered.
 - Details of the water supply.
-

Scale Plan / Drawing

The first step is to produce a scale plan/drawing of your property.

A landscape or building site plan would be ideal for this. Ensure it has a scale or some measurements on it that show the size of the property.

Alternatively, using the included grid layout paper, draw your property, house etc to scale.

e.g.: 1 square = 1m. See example.

Drawing Example

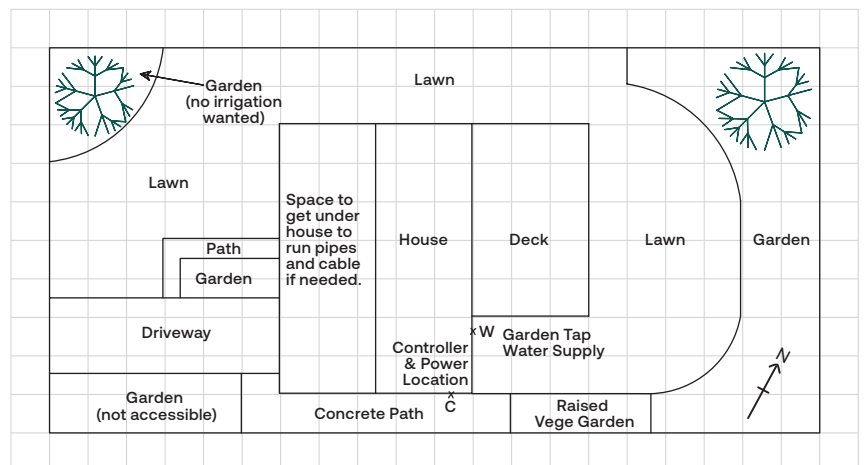

Both of the above options will require the following noted on them:

-
- Areas to be irrigated – lawns, gardens, vegetables etc clearly marked.
-
- Water supply type (pump, tap or mains tee-off) and location.
-
- Power supply location (for powered controller) or note if battery controller preferred. Powered controllers are generally longer lasting, so if there is no power then think about having an electrician install a standard 3-pin 240V outdoor power socket.
-
- Trees, decks, paths etc clearly marked and note whether there is under house access.
-
- Indication of North.
-

Scale Plan / Drawing

1 square = 1m

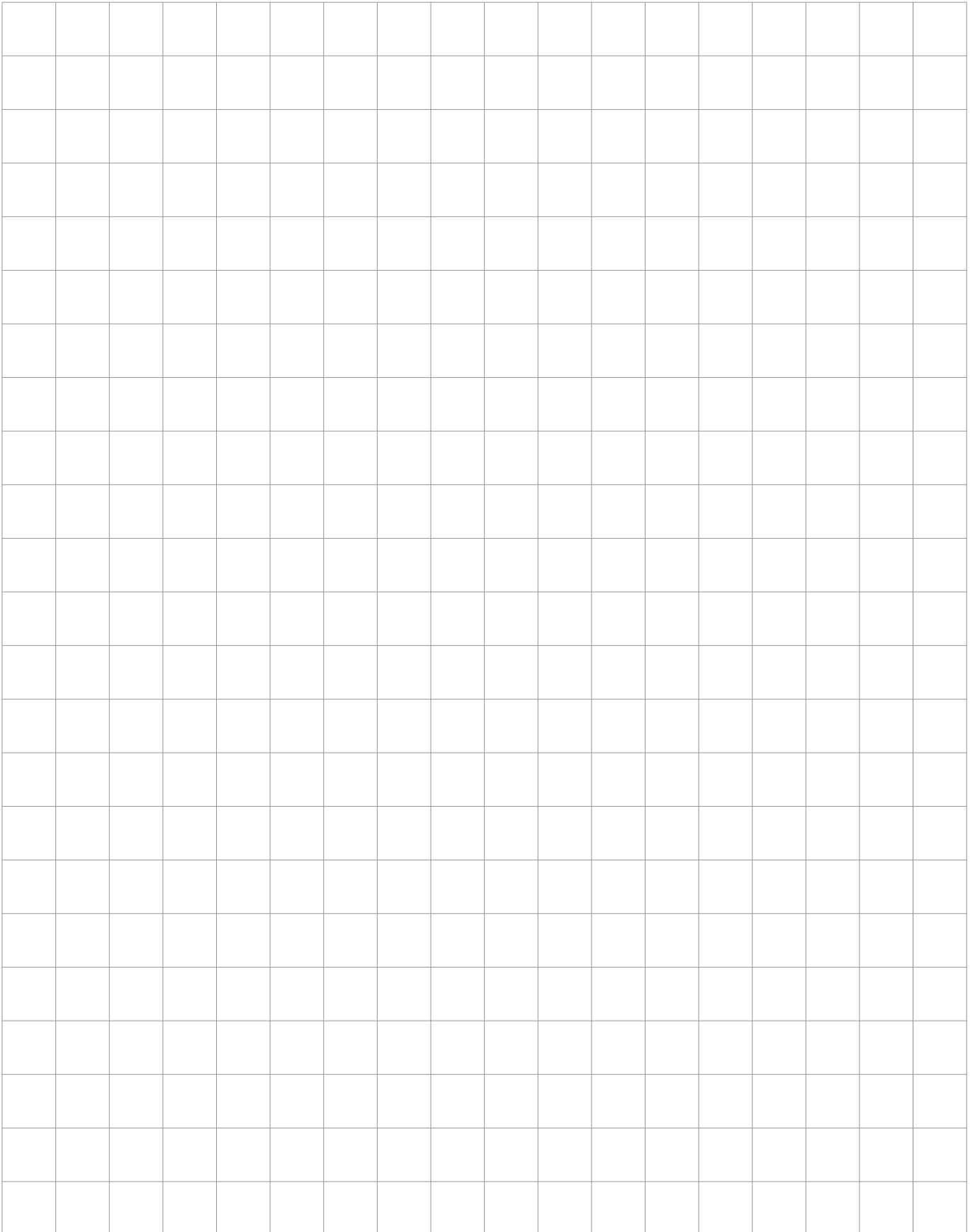

Water Supply

The next step is to figure out the available water supply.

Mains Supply

If you are running the system from your mains water supply, then using the tap that you wish to have as your irrigation supply, or the tap closest to the properties mainline that you will be teeing into, do a "bucket test" water supply test.

Grab a bucket (noting the size of the bucket, 10L is the best), have a stopwatch ready, turn your tap on full, place the bucket under the tap and time how long it takes to fill the bucket up.

➤ NB: If you have access to a pressure gauge and isolation valve, fit them to the tap and take the bucket test at a pressure of 250kPa.

Record the results here:

Bucket size (in Litres): _____ Time to fill bucket: _____

To work out your own flow rate, the formula is:

_____ (Size of bucket x 60) ÷ time taken to fill bucket = _____ L/min

If you have done the bucket test with a pressure gauge you will now have your design flow at 250kPa.

If you have taken it without a pressure gauge you have what is called an open flow rate. 80% of this value is used to allow for pressure to operate the irrigation components.

This is will then be your design flow.

_____ Open flow rate value (from above) x 0.8 = _____ L/min

Pump System

Is the system to be run from a pump? If you have an existing pump, then note the make and model of the pump below then look up the manufacturers pump curve:

Make: _____ Model: _____

Pump Duty: _____ @250kPa

To ensure you have enough water for the system, take note of how much storage capacity your tank/s have. _____ L

Then ask, how is the tank topped up and what is the flow rate of this? Will there be enough water for the system?

Product Specification

Extra information required to assist product selection:

➤ What type of controller do you want to use? Battery powered or mains powered.	<input type="checkbox"/> Battery	<input type="checkbox"/> Mains Powered
➤ Do you want to be able to monitor/operate the controller when away from the property?	<input type="checkbox"/> Yes	<input type="checkbox"/> No
➤ If yes, is there WiFi connection available?	<input type="checkbox"/> Yes	<input type="checkbox"/> No
➤ Will the system have a Rain Switch/Sensor?	<input type="checkbox"/> Yes	<input type="checkbox"/> No
➤ Are the properties lawns soil or sand based?	<input type="checkbox"/> Soil	<input type="checkbox"/> Sand
➤ Is the property flat or does it slope?	<input type="checkbox"/> Flat	<input type="checkbox"/> Sloped

Sprinkler Layout Example

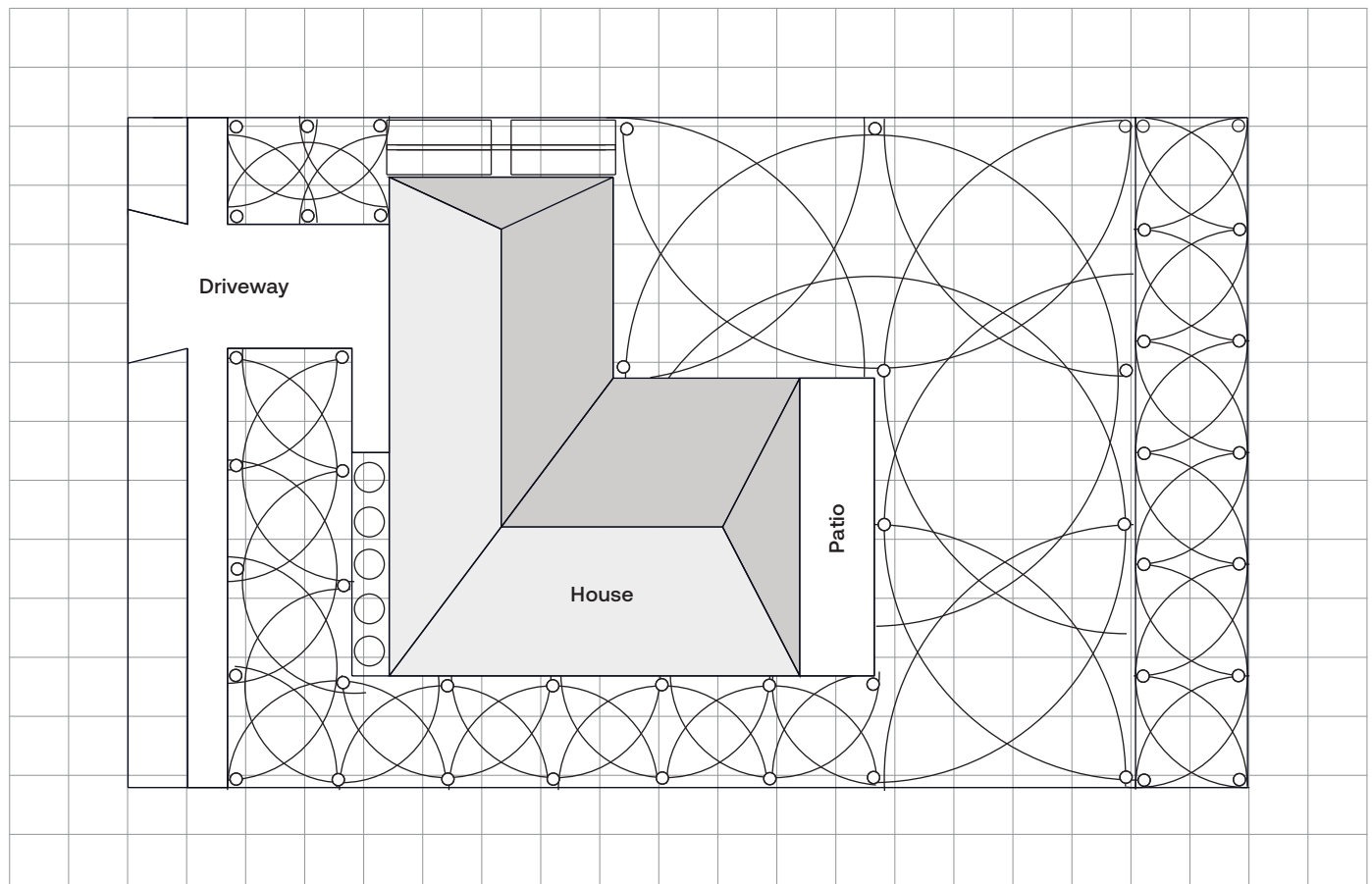





Nozzle Performance





HE-VAN - High Efficiency Variable Arc Nozzles.

R-VAN - Rotary Nozzles.

VAN - Variable Arc Nozzles.





HE-VAN Nozzles





8 Series HE-VAN		24° Trajectory				
Nozzle	Pressure (bar)	Radius (m)	Flow (m ³ /h)	Flow (L/m)	Precip (mm/h)	Precip (mm/h)
360° 	1.0	1.5	0.19	3.14	82	95
	1.4	1.8	0.22	3.62	66	76
	1.7	2.1	0.25	4.05	54	62
	2.1	2.4	0.27	4.43	45	52
270° 	1.0	1.5	0.14	2.35	82	95
	1.4	1.8	0.16	2.72	66	76
	1.7	2.1	0.18	3.04	54	62
	2.1	2.4	0.20	3.33	45	52
180° 	1.0	1.5	0.10	1.57	82	95
	1.4	1.8	0.11	1.81	66	76
	1.7	2.1	0.12	2.02	54	62
	2.1	2.4	0.13	2.22	45	52
90° 	1.0	1.5	0.05	0.78	82	95
	1.4	1.8	0.05	0.91	66	76
	1.7	2.1	0.06	1.01	54	62
	2.1	2.4	0.07	1.11	45	52

10 Series HE-VAN		27° Trajectory				
Nozzle	Pressure (bar)	Radius (m)	Flow (m ³ /h)	Flow (L/m)	Precip (mm/h)	Precip (mm/h)
360° 	1.0	2.1	0.29	4.78	64	74
	1.4	2.4	0.34	5.52	56	65
	1.7	2.7	0.37	6.17	50	57
	2.1	3.1	0.41	6.76	44	51
270° 	1.0	2.1	0.22	3.59	64	74
	1.4	2.4	0.25	4.14	56	65
	1.7	2.7	0.28	4.63	50	57
	2.1	3.1	0.31	5.07	44	51
180° 	1.0	2.1	0.15	2.39	64	74
	1.4	2.4	0.17	2.76	56	65
	1.7	2.7	0.19	3.09	50	57
	2.1	3.1	0.21	3.38	44	51
90° 	1.0	2.1	0.07	1.20	64	74
	1.4	2.4	0.08	1.38	56	65
	1.7	2.7	0.09	1.54	50	57
	2.1	3.1	0.10	1.69	44	51





➤ Use HE-VAN, R-VAN & VAN nozzles on 1800 Series Sprinkler Bodies.











12 Series HE-VAN		23° Trajectory				
Nozzle	Pressure (bar)	Radius (m)	Flow (m ³ /h)	Flow (L/m)	Precip (mm/h)	Precip (mm/h)
360° 	1.0	2.7	0.38	6.33	50.5	58.3
	1.4	3.0	0.44	7.31	47.3	54.6
	1.7	3.4	0.49	8.18	43.7	50.4
	2.1	3.7	0.54	8.96	40.2	46.4
270° 	1.0	2.7	0.28	4.75	50.5	58.3
	1.4	3.0	0.33	5.48	47.3	54.6
	1.7	3.4	0.37	6.16	43.7	50.4
	2.1	3.7	0.40	6.72	40.2	46.4
180° 	1.0	2.7	0.19	3.17	50.5	58.3
	1.4	3.0	0.22	3.66	47.3	54.6
	1.7	3.4	0.25	4.09	43.7	50.4
	2.1	3.7	0.27	4.48	40.2	46.4
90° 	1.0	2.7	0.09	1.58	50.5	58.3
	1.4	3.0	0.11	1.83	47.3	54.6
	1.7	3.4	0.12	2.04	43.7	50.4
	2.1	3.7	0.13	2.24	40.2	46.4

15 Series HE-VAN		25° Trajectory				
Nozzle	Pressure (bar)	Radius (m)	Flow (m ³ /h)	Flow (L/m)	Precip (mm/h)	Precip (mm/h)
360° 	1.0	3.4	0.59	9.91	52.9	61.1
	1.4	3.7	0.69	11.44	51.3	59.3
	1.7	4.3	0.77	12.79	42.2	48.7
	2.1	4.6	0.84	14.01	40.2	46.5
270° 	1.0	3.4	0.45	7.43	52.9	61.1
	1.4	3.7	0.51	8.58	51.3	59.3
	1.7	4.3	0.58	9.59	42.2	48.7
	2.1	4.6	0.63	10.51	40.2	46.5
180° 	1.0	3.4	0.30	4.95	52.9	61.1
	1.4	3.7	0.34	5.72	51.3	59.3
	1.7	4.3	0.38	6.39	42.2	48.7
	2.1	4.6	0.42	7.00	40.2	46.5
90° 	1.0	3.4	0.15	2.48	52.9	61.1
	1.4	3.7	0.17	2.86	51.3	59.3
	1.7	4.3	0.19	3.20	42.2	48.7
	2.1	4.6	0.21	3.50	40.2	46.5

R-VAN Adjustable Arc Nozzles (45° to 270°)

R-VAN14		2.4 to 4.6m					
Nozzle	Pressure (bar)	Radius (m)	Flow (m ³ /h)	Flow (L/m)	Precip (mm/h)	Precip (mm/h)	
270° 	2.1	4.0	0.19	3.18	16	19	
	2.4	4.0	0.20	3.29	17	19	
	2.8	4.3	0.21	3.48	15	18	
	3.1	4.3	0.21	3.56	16	18	
	3.4	4.6	0.25	4.20	16	19	
210° 	2.1	4.0	0.15	2.46	16	19	
	2.4	4.0	0.15	2.57	17	19	
	2.8	4.3	0.16	2.73	15	18	
	3.1	4.3	0.17	2.76	16	18	
	3.4	4.6	0.20	3.26	16	19	
180° 	2.1	4.0	0.13	2.12	16	19	
	2.4	4.0	0.13	2.20	17	19	
	2.8	4.3	0.14	2.31	15	18	
	3.1	4.3	0.14	2.38	16	18	
	3.4	4.6	0.17	2.80	16	19	
90° 	2.1	4.0	0.06	1.06	16	19	
	2.4	4.0	0.07	1.10	17	19	
	2.8	4.3	0.07	1.17	16	18	
	3.1	4.3	0.07	1.21	15	18	
	3.4	4.6	0.08	1.40	16	19	
	3.8	4.6	0.09	1.48	17	20	

R-VAN18		4.0 to 5.5m					
Nozzle	Pressure (bar)	Radius (m)	Flow (m ³ /h)	Flow (L/m)	Precip (mm/h)	Precip (mm/h)	
270° 	2.1	4.9	0.29	4.77	17	19	
	2.4	4.9	0.31	5.11	16	19	
	2.8	5.2	0.32	5.38	16	19	
	3.1	5.2	0.34	5.72	16	19	
	3.4	5.5	0.36	5.94	15	18	
210° 	2.1	4.9	0.22	3.71	16	19	
	2.4	4.9	0.24	3.97	17	20	
	2.8	5.2	0.25	4.16	16	19	
	3.1	5.2	0.27	4.43	16	20	
	3.4	5.5	0.28	4.62	16	18	
180° 	2.1	4.9	0.19	3.22	17	19	
	2.4	4.9	0.21	3.44	16	19	
	2.8	5.2	0.22	3.71	16	19	
	3.1	5.2	0.23	3.82	16	19	
	3.4	5.5	0.24	4.05	15	18	
90° 	2.1	4.9	0.10	1.59	17	19	
	2.4	4.9	0.11	1.78	16	19	
	2.8	5.2	0.11	1.89	16	19	
	3.1	5.2	0.11	1.89	16	19	
	3.4	5.5	0.12	2.04	15	18	
	3.8	5.5	0.13	2.20	15	18	

R-VAN24		5.2 to 7.3m					
Nozzle	Pressure (bar)	Radius (m)	Flow (m ³ /h)	Flow (L/m)	Precip (mm/h)	Precip (mm/h)	
270° 	2.1	5.8	0.41	6.81	16	19	
	2.4	6.1	0.44	7.38	16	18	
	2.8	6.7	0.52	8.74	15	18	
	3.1	7.0	0.57	9.54	15	18	
	3.4	7.3	0.64	10.67	16	19	
210° 	2.1	5.8	0.32	5.30	16	19	
	2.4	6.1	0.35	5.75	16	18	
	2.8	6.7	0.41	6.81	15	18	
	3.1	7.0	0.45	7.42	15	18	
	3.4	7.3	0.50	8.29	16	19	
180° 	2.1	5.8	0.27	4.54	16	19	
	2.4	6.1	0.30	4.92	16	18	
	2.8	6.7	0.35	5.83	15	18	
	3.1	7.0	0.38	6.36	15	18	
	3.4	7.3	0.43	7.12	16	19	
90° 	2.1	5.8	0.14	2.27	16	19	
	2.4	6.1	0.15	2.46	16	18	
	2.8	6.7	0.17	2.91	15	18	
	3.1	7.0	0.19	3.18	15	18	
	3.4	7.3	0.21	3.56	16	19	
	3.8	7.3	0.22	3.63	16	19	

R-VAN Full Circle Nozzles (360°)

R-VAN14-360		2.4 to 4.6m					
Nozzle	Pressure (bar)	Radius (m)	Flow (m ³ /h)	Flow (L/m)	Precip (mm/h)	Precip (mm/h)	
360° 	2.1	4.0	0.25	4.16	16	18	
	2.4	4.0	0.25	4.24	16	19	
	2.8	4.3	0.28	4.62	15	18	
	3.1	4.3	0.29	4.81	16	18	
	3.4	4.6	0.32	5.34	15	18	
	3.8	4.6	0.33	5.49	16	18	

R-VAN18-360		4.0 to 5.5m					
Nozzle	Pressure (bar)	Radius (m)	Flow (m ³ /h)	Flow (L/m)	Precip (mm/h)	Precip (mm/h)	
360° 	2.1	4.9	0.38	6.25	16	18	
	2.4	4.9	0.38	6.32	16	19	
	2.8	5.2	0.41	6.81	15	18	
	3.1	5.2	0.42	7.00	16	18	
	3.4	5.5	0.47	7.76	15	18	
	3.8	5.5	0.48	7.99	16	18	

R-VAN24-360		4.0 to 5.5m					
Nozzle	Pressure (bar)	Radius (m)	Flow (m ³ /h)	Flow (L/m)	Precip (mm/h)	Precip (mm/h)	
180° 	2.1	5.8	0.53	8.90	16	18	
	2.4	6.1	0.57	9.54	16	19	
	2.8	6.7	0.71	11.85	15	18	
	3.1	7.0	0.79	13.17	16	18	
	3.4	7.3	0.82	13.67	15	18	
	3.8	7.3	0.85	14.16	16	18	

R-VAN Strip Nozzles (Left Corner, Side, Right Corner)





R-VAN-LCS		1.5 x 4.6m					
Nozzle	Pressure (bar)	W x L (m)	Flow (m ³ /h)	Flow (L/m)	Precip (mm/h)	Precip (mm/h)	
Left Corner Strip 	2.1	1.2x4.3	0.04	0.68	16	16	
	2.4	1.5x4.6	0.05	0.83	14	14	
	2.8	1.5x4.6	0.05	0.87	15	15	
	3.1	1.5x4.6	0.05	0.91	16	16	
	3.4	1.5x4.6	0.06	0.95	16	16	
	3.8	1.8x4.9	0.06	1.06	14	14	

R-VAN-SST		1.5 x 9.1m					
Nozzle	Pressure (bar)	W x L (m)	Flow (m ³ /h)	Flow (L/m)	Precip (mm/h)	Precip (mm/h)	
Side Strip 	2.1	1.2x8.5	0.08	1.36	16	16	
	2.4	1.5x9.1	0.10	1.67	14	14	
	2.8	1.5x9.1	0.10	1.74	15	15	
	3.1	1.5x9.1	0.11	1.82	16	16	
	3.4	1.5x9.1	0.11	1.89	16	16	
	3.8	1.8x9.8	0.13	2.12	14	14	





R-VAN-RCS		1.5 x 4.6m					
Nozzle	Pressure (bar)	W x L (m)	Flow (m ³ /h)	Flow (L/m)	Precip (mm/h)	Precip (mm/h)	
Right Corner Strip 	2.1	1.2x4.3	0.04	0.68	16	16	
	2.4	1.5x4.6	0.05	0.83	14	14	
	2.8	1.5x4.6	0.05	0.87	15	15	
	3.1	1.5x4.6	0.05	0.91	16	16	
	3.4	1.5x4.6	0.06	0.95	16	16	
	3.8	1.8x4.9	0.06	1.06	14	14	

VAN Nozzles





4 Series VAN 0° Trajectory

Nozzle	Pressure (bar)	Radius (m)	Flow (m3/h)	Flow (L/m)	Precip (mm/h)	Precip (mm/h)	
	330°	1.0	0.9	0.14	2.3	189	218
	1.5	1.0	0.17	2.8	183	215	
	2.0	1.2	0.20	3.3	152	176	
	2.1	1.2	0.20	3.3	152	176	
	270°	1.0	0.9	0.12	2.0	198	229
	1.5	1.0	0.14	2.3	187	216	
	2.0	1.2	0.16	2.7	148	171	
	2.1	1.2	0.17	2.8	157	181	
	180°	1.0	0.9	0.07	1.2	173	200
	1.5	1.0	0.09	1.5	180	208	
	2.0	1.2	0.10	1.7	139	161	
	2.1	1.2	0.10	1.7	139	161	
	90°	1.0	0.9	0.05	0.8	247	285
	1.5	1.0	0.06	0.9	240	277	
	2.0	1.2	0.06	1.1	167	193	
	2.1	1.2	0.07	1.1	194	224	





10 Series VAN 10° Trajectory

Nozzle	Pressure (bar)	Radius (m)	Flow (m3/h)	Flow (L/m)	Precip (mm/h)	Precip (mm/h)	
	360°	1.0	2.1	0.44	7.3	96	111
	1.5	2.4	0.53	9.0	89	103	
	2.0	2.7	0.57	9.8	76	88	
	2.1	3.1	0.59	9.8	63	73	
	270°	1.0	2.1	0.33	5.5	96	111
	1.5	2.4	0.40	6.8	89	103	
	2.0	2.7	0.43	7.8	76	88	
	2.1	3.1	0.48	7.9	68	79	
	180°	1.0	2.1	0.22	3.7	96	111
	1.5	2.4	0.27	4.6	89	103	
	2.0	2.7	0.29	5.3	76	88	
	2.1	3.1	0.33	5.5	71	82	
	90°	1.0	2.1	0.11	1.8	96	111
	1.5	2.4	0.13	2.3	89	103	
	2.0	2.7	0.14	2.7	76	88	
	2.1	3.1	0.17	2.8	73	85	





18 Series VAN 26° Trajectory

Nozzle	Pressure (bar)	Radius (m)	Flow (m3/h)	Flow (L/m)	Precip (mm/h)	Precip (mm/h)	
	360°	1.0	4.3	0.96	15.9	52	60
	1.5	4.8	1.07	18.0	47	55	
	2.0	5.4	1.20	19.8	41	48	
	2.1	5.5	1.21	20.1	40	46	
	270°	1.0	4.3	0.72	12.0	52	60
	1.5	4.8	0.80	13.5	47	55	
	2.0	5.4	0.90	14.8	41	48	
	2.1	5.5	0.91	15.1	40	46	
	180°	1.0	4.3	0.48	8.0	52	60
	1.5	4.8	0.54	9.0	47	55	
	2.0	5.4	0.60	9.9	41	48	
	2.1	5.5	0.61	10.1	40	46	
	90°	1.0	4.3	0.24	4.0	52	60
	1.5	4.8	0.27	4.5	47	55	
	2.0	5.4	0.30	5.0	41	48	
	2.1	5.5	0.30	5.0	40	46	





6 Series VAN 0° Trajectory

Nozzle	Pressure (bar)	Radius (m)	Flow (m3/h)	Flow (L/m)	Precip (mm/h)	Precip (mm/h)	
	330°	1.0	1.2	0.19	3.2	144	166
	1.5	1.5	0.23	3.8	112	129	
	2.0	1.8	0.27	4.5	91	105	
	2.1	1.8	0.27	4.5	91	105	
	270°	1.0	1.2	0.18	3.0	167	193
	1.5	1.5	0.21	3.5	124	143	
	2.0	1.8	0.24	4.1	99	114	
	2.1	1.8	0.25	4.2	103	119	
	180°	1.0	1.2	0.10	1.6	139	161
	1.5	1.5	0.11	1.9	98	113	
	2.0	1.8	0.13	2.2	80	92	
	2.1	1.8	0.14	2.3	86	99	
	90°	1.0	1.2	0.06	1.0	167	193
	1.5	1.5	0.07	1.2	124	143	
	2.0	1.8	0.08	1.4	99	114	
	2.1	1.8	0.08	1.4	99	114	





12 Series VAN 15° Trajectory

Nozzle	Pressure (bar)	Radius (m)	Flow (m3/h)	Flow (L/m)	Precip (mm/h)	Precip (mm/h)	
	360°	1.0	2.7	0.35	5.80	48	55
	1.5	3.2	0.44	7.37	43	50	
	2.0	3.6	0.52	8.75	41	47	
	2.1	3.7	0.54	9.02	40	46	
	270°	1.0	2.7	0.26	4.35	48	55
	1.5	3.2	0.33	5.53	43	50	
	2.0	3.6	0.39	6.56	41	47	
	2.1	3.7	0.41	5.76	40	46	
	180°	1.0	2.7	0.17	2.90	48	55
	1.5	3.2	0.22	3.69	43	50	
	2.0	3.6	0.26	4.37	41	47	
	2.1	3.7	0.27	4.51	40	46	
	90°	1.0	2.7	0.09	1.45	48	55
	1.5	3.2	0.11	1.84	43	50	
	2.0	3.6	0.13	2.19	41	47	
	2.1	3.7	0.14	2.25	40	46	

8 Series VAN 5° Trajectory

Nozzle	Pressure (bar)	Radius (m)	Flow (m3/h)	Flow (L/m)	Precip (mm/h)	Precip (mm/h)	
	330°	1.0	1.8	0.27	4.6	91	105
	1.5	2.1	0.32	5.4	79	91	
	2.0	2.3	0.38	6.3	78	90	
	2.1	2.4	0.39	6.4	74	86	
	270°	1.0	1.8	0.25	4.2	103	119
	1.5	2.1	0.30	4.9	91	105	
	2.0	2.3	0.34	5.8	86	99	
	2.1	2.4	0.35	5.9	81	94	
	180°	1.0	1.8	0.19	3.2	117	135
	1.5	2.1	0.23	3.8	104	120	
	2.0	2.3	0.26	4.4	98	113	
	2.1	2.4	0.27	4.5	94	109	
	90°	1.0	1.8	0.12	1.9	148	171
	1.5	2.1	0.14	2.3	127	147	
	2.0	2.3	0.16	2.7	121	140	
	2.1	2.4	0.16	2.7	111	128	

15 Series VAN 23° Trajectory

Nozzle	Pressure (bar)	Radius (m)	Flow (m3/h)	Flow (L/m)	Precip (mm/h)	Precip (mm/h)	
	360°	1.0	3.4	0.60	9.8	52	60
	1.5	3.9	0.72	11.8	47	55	
	2.0	4.5	0.84	13.7	41	48	
	2.1	4.6	0.84	14.0	40	46	
	270°	1.0	3.4	0.45	7.4	52	60
	1.5	3.9	0.54	8.8	47	55	
	2.0	4.5	0.63	10.3	41	48	
	2.1	4.6	0.63	10.5	40	46	
	180°	1.0	3.4	0.30	4.9	52	60
	1.5	3.9	0.36	5.9	47	55	
	2.0	4.5	0.42	6.9	41	48	
	2.1	4.6	0.42	7.0	40	46	
	90°	1.0	3.4	0.15	2.5	52	60
	1.5	3.9	0.18	2.9	47	55	
	2.0	4.5	0.21	3.4	41	48	
	2.1	4.6	0.21	3.5	40	46	

15 Strip Series

15EST 30° Trajectory

Nozzle	Pressure (bar)	W x L (m)	Flow (m3/h)	Flow (L/m)	
	End Strip	1.0	1.2x4.0	0.10	1.7
	1.5	1.2x4.3	0.11	2.0	
	2.0	1.2x4.3	0.13	2.3	
	2.5	1.2x4.6	0.14	2.3	

15RCS 30° Trajectory

Nozzle	Pressure (bar)	W x L (m)	Flow (m3/h)	Flow (L/m)	
	Right Corner Strip	1.0	0.8x3.2	0.08	1.3
	1.5	1.0x3.9	0.09	1.6	
	2.0	1.2x4.5	0.11	1.8	
	2.5	1.2x4.6	0.11	1.9	

15CST 30° Trajectory

Nozzle	Pressure (bar)	W x L (m)	Flow (m3/h)	Flow (L/m)	
	Side Strip	1.0	1.2x7.9	0.20	3.4
	1.5	1.2x8.5	0.23	4.0	
	2.0	1.2x8.5	0.25	4.5	
	2.5	1.2x9.2	0.27	4.6	

15CST 30° Trajectory

Nozzle	Pressure (bar)	W x L (m)	Flow (m3/h)	Flow (L/m)	
	Centre Strip	1.0	1.2x7.9	0.20	3.4
	1.5	1.2x8.5	0.23	4.0	
	2.0	1.2x8.5	0.25	4.5	
	2.5	1.2x9.2	0.27	4.6	

15LCS 30° Trajectory

Nozzle	Pressure (bar)	W x L (m)	Flow (m3/h)	Flow (L/m)	
	Left Corner Strip	1.0	0.8x3.2	0.08	1.3
	1.5	1.0x3.9	0.09	1.6	
	2.0	1.2x4.5	0.11	1.8	
	2.5	1.2x4.6	0.11	1.9	

15CST 30° Trajectory

Nozzle	Pressure (bar)	W x L (m)	Flow (m3/h)	Flow (L/m)	
	Side Strip	1.0	2.7x4.6	0.30	5.1
	1.5	2.7x4.9	0.33	5.8	
	2.0	2.7x5.5	0.36	6.5	
	2.5	2.7x5.5	0.39	6.5	



Rotor Sprinkler Nozzle Performance

3500 Series Rotor Pop-Up Sprinklers

5000 Series Rotor Pop-Up Sprinklers



3500 Series Nozzle Performance

Pressure (bar)	Nozzle	Radius (m)	Flow (m ³ /h)	Flow (L/m)	Metric	
					■ Precip (mm/h)	▲ Precip (mm/h)
1.7	0.75	4.6	0.12	2.04	12	14
	1.0	6.1	0.17	2.91	9	11
	1.5	7.0	0.24	4.01	10	11
	2.0	8.2	0.32	5.30	9	11
	3.0	8.8	0.49	8.21	13	15
	4.0	9.4	0.67	11.24	15	17
2.0	0.75	4.8	0.13	2.24	12	13
	1.0	6.2	0.19	3.14	10	11
	1.5	7.0	0.26	4.35	11	12
	2.0	8.2	0.34	5.74	10	12
	3.0	9.1	0.53	8.87	13	15
	4.0	9.7	0.73	12.17	16	18
2.5	0.75	5.2	0.16	2.58	12	13
	1.0	6.4	0.21	3.55	10	12
	1.5	7.0	0.30	4.94	12	14
	2.0	8.2	0.39	6.51	12	13
	3.0	9.4	0.60	10.03	13	16
	4.0	10.1	0.83	13.82	16	19
3.0	0.75	5.2	0.17	2.86	13	15
	1.0	6.4	0.24	3.93	12	13
	1.5	7.3	0.33	5.49	12	14
	2.0	8.2	0.43	7.17	13	15
	3.0	9.4	0.67	11.13	15	17
	4.0	10.6	0.92	15.32	16	19
3.5	0.75	5.4	0.19	3.09	13	15
	1.0	6.6	0.26	4.27	12	14
	1.5	7.3	0.36	5.97	13	15
	2.0	8.4	0.47	7.79	13	15
	3.0	9.6	0.71	11.90	15	18
	4.0	10.7	1.00	16.66	18	20
3.8	0.75	5.5	0.19	3.22	13	15
	1.0	6.7	0.27	4.47	12	14
	1.5	7.3	0.37	6.25	14	16
	2.0	8.5	0.49	8.14	13	15
	3.0	9.8	0.74	12.30	16	18
	4.0	10.7	1.04	17.41	18	21

5000 Series Std. Angle Nozzle Performance

Metric

Pressure (bar)	Nozzle	Radius (m)	Flow (m ³ /h)	Flow (L/m)	Precip (mm/h)	Precip (mm/h)
1.7	1.5	10.10	0.25	4.2	5	6
	2.0	10.70	0.34	5.4	6	7
	2.5	10.70	0.41	6.6	7	8
	3.0	11.00	0.51	8.4	8	10
	4.0	11.3	0.66	10.8	10	12
	5.0	11.90	0.84	13.8	12	14
	6.0	11.90	0.97	16.2	14	16
	8.0	11.00	1.34	22.2	22	26
2.0	1.5	10.20	0.28	4.8	5	6
	2.0	10.80	0.36	6.0	6	7
	2.5	10.90	0.44	7.2	7	9
	3.0	11.20	0.55	9.0	9	10
	4.0	11.6	0.71	12.0	11	12
	5.0	12.10	0.91	15.0	12	14
	6.0	12.40	1.05	17.4	14	16
	8.0	11.80	1.45	24.0	21	24
2.5	1.5	10.40	0.31	5.4	6	7
	2.0	11.00	0.41	6.6	7	8
	2.5	11.30	0.50	8.4	8	9
	3.0	11.20	0.62	10.2	9	11
	4.0	12.3	0.81	13.2	11	13
	5.0	12.70	1.03	17.4	13	15
	6.0	13.20	1.21	20.4	14	16
	8.0	13.30	1.63	27.0	19	21
3.0	1.5	10.60	0.34	6.0	6	7
	2.0	11.20	0.45	7.8	7	8
	2.5	11.30	0.56	9.6	9	10
	3.0	12.10	0.69	11.4	9	11
	4.0	12.7	0.89	15.0	11	13
	5.0	13.50	1.13	18.6	12	14
	6.0	13.90	1.34	22.2	14	16
	8.0	14.10	1.79	30.0	18	21
3.5	1.5	10.70	0.37	6.0	7	8
	2.0	11.30	0.49	8.4	8	9
	2.5	11.30	0.60	10.2	9	11
	3.0	12.20	0.74	12.6	10	12
	4.0	12.8	0.97	16.2	12	14
	5.0	13.70	1.23	20.4	13	15
	6.0	14.20	1.45	24.0	14	17
	8.0	14.90	1.93	32.4	18	20
4.0	1.5	10.60	0.40	6.6	7	8
	2.0	11.10	0.52	9.0	8	10
	2.5	11.30	0.64	10.8	10	12
	3.0	12.20	0.80	13.2	11	12
	4.0	12.8	1.04	17.4	13	15
	5.0	13.70	1.32	22.2	14	16
	6.0	14.90	1.55	25.8	15	17
	8.0	15.20	2.06	34.2	18	21
4.5	1.5	10.40	0.42	7.2	8	9
	2.0	10.70	0.55	9.0	10	11
	2.5	11.30	0.68	11.4	11	12
	3.0	12.20	0.84	13.8	11	13
	4.0	12.8	1.10	18.0	13	15
	5.0	13.70	1.40	23.4	15	17
	6.0	14.60	1.64	28.2	15	18
	8.0	15.20	2.19	36.6	19	22

5000 Series Low Angle Nozzle Performance

Metric

Pressure (bar)	Nozzle	Radius (m)	Flow (m ³ /h)	Flow (L/m)	Precip (mm/h)	Precip (mm/h)
1.7	1.0 LA	7.60	0.17	3.0	6	7
	1.5 LA	8.20	0.26	4.2	8	9
	2.0 LA	8.80	0.33	5.4	9	10
	3.0 LA	8.80	0.51	8.4	13	15
2.0	1.0 LA	8.00	0.18	3.0	6	6
	1.5 LA	8.60	0.28	4.8	8	9
	2.0 LA	9.10	0.36	6.0	9	10
2.5	3.0 LA	9.30	0.55	9.0	13	15
	1.0 LA	8.60	0.20	3.6	5	6
	1.5 LA	9.20	0.32	5.4	8	9
3.0	2.0 LA	9.50	0.41	6.6	9	10
	3.0 LA	10.10	0.62	10.2	12	14
	1.0 LA	8.80	0.22	3.6	6	7
3.5	1.5 LA	9.40	0.35	6.0	8	9
	2.0 LA	9.70	0.45	7.8	10	11
	3.0 LA	10.60	0.68	11.4	12	14
4.0	1.0 LA	8.80	0.24	4.2	6	7
	1.5 LA	9.40	0.38	6.6	9	10
	2.0 LA	9.90	0.49	8.4	10	11
	3.0 LA	10.80	0.74	12.6	13	15
4.0	1.0 LA	8.80	0.26	4.2	7	8
	1.5 LA	9.40	0.41	6.6	9	11
	2.0 LA	10.10	0.52	9.0	10	12
	3.0 LA	11.00	0.80	13.2	13	15
4.0	1.0 LA	8.80	0.27	4.8	7	8
	1.5 LA	9.40	0.44	7.2	10	11
	2.0 LA	10.10	0.56	9.0	11	13
4.0	3.0 LA	11.00	0.84	13.8	14	16



Controllers

	Stations	Programs	Remote Management	Flow Sensing	Automatic Weather Based Adjustments	Key Solution
ESP-TM2	Fixed 4, 6, 8 or 12	3	Yes	No	Requires: LNK WiFi	– Cost Effective and Easy to Use
RC2 CONTROLLER	Fixed 8	3	Yes	No	Built-in Wifi Based Adjustments	– Seamless mobile pairing and fast intuitive programming
ESP-ME3	Modular up to 22	4	Yes	High & low flow leak detection	Requires: LNK WiFi	– Advanced residential controller – 1 master valve – 1 flow sensor
ESP-LXME2 ESP-LXME2PRO	Modular up to 48 (5 simulstations)	40	Yes	High & low flow leak detection *Pro only	Requires: iQ4	– Next generation modular control – PRO = flow and 2nd – M.V. output for station level pump control
ESP-LXD	Modular 50 to 200 (8 simulstations)	4	Yes	High & low flow leak detection	Requires: iQ4	– Flexible 2-Wire control – 5 master valves – 5 flow sensors
ESP-LXIVM ESP-LXIVM-PRO	Fixed 60 or 240 (8 or 16 simulstations)	10 or 40	Yes	High & low flow leak detection	Requires: iQ4	– Revolutionary 2-Wire control with smart valve technology – 5 or 10 master valves – 5 or 10 flow sensors
ESP-9V	Fixed 1, 2, 4 or 6	3	No	No	Monthly Seasonal Adjust	– Simple programming with large backlit display – Submersible & cost effective
TBOS-BT	Fixed 1, 2, or 4	3		No	Monthly Seasonal Adjust	– Smartphone control with a vandal-proof design

Dripline

Inline emitter tubing is ideal for irrigating any rows of vegetation, hedges, trees, and gardens.

- Laid at 500mm spacings between rows.
- 13mm tube with 2.1l/hr drippers and a 30cm spacing between drippers.
- 100m = 11.67 l/min.



Valves

DV and HV electric valves are ideal for residential installations.

Available with 24V solenoid (for 230V controller) or with 9V solenoid (for battery powered controller).

DV Series Valves

The market standard.



– From 0.045 to 9.08 m³/h.

HV Series Valves

Rain Bird quality at the best price.



– From 1.0 to 10.4 bars.

Low Flow Valve Kit

20mm DV Valve - Low Flow.

Specifically designed for drip irrigation systems.



– From 0.045 to 1.8 m³/h.

– From 1.0 to 10.3 bars.

➤ Other valves available for larger and commercial sites.

Rain Shutoff Devices

Electronic rain shutoff devices are indispensable in all automatic irrigation systems for residential use.

They monitor rainfall or freeze levels and automatically override the controller to prevent unnecessary irrigation.

➤ Other parts to consider to complete your system:



WR2 Wireless
Rain Freeze Sensor



RSD-BEx Wired
Rain Sensor



SMRT-Y Soil
Moisture Sensor

- Isolation Valves
- Filter
- Fittings
- Pipe
- Valve Box
- Cable and connectors

Installation Tips

When it comes to installing your irrigation system, these tips will ensure a smooth and effective process.

➤ Pegs

Pegs are useful to mark locations of sprinklers and a string line will assist in keeping trenches straight. Trenching shovels or trenching machines can be hired to make trenching easier.

➤ Assemble Screw Fittings

Assemble fittings which screw together. Screw sprinklers to swing joints and then screw to tee or elbow. Screw threaded fittings into solenoid valves (thread seal tape should be used on all threads except where the swing joints screws into the sprinkler). Place these fittings alongside trenches where they are to be installed.

➤ Trenches

Dig trenches 100 - 150mm deep, putting any sod on one side and any dirt or soil on the other side of the trench.

Ensure that when trenching that all telephone wires, gas and water lines are avoided.

➤ Pipe

Pin the pipe into the trench to avoid it working it's way to the surface.

➤ Pop-up Sprinkler Installation

When installing pop-up sprinklers, they are installed just below the surface. This avoids damage from lawn mowers.

Pin the swing arm near the base of the sprinkler to reduce sprinkler movement and hand pack soil around the sprinkler body.

Once all pipe work, cable and sprinklers are in place, flush the system so all dirt is removed. Check mainline for leaks, then install sprinkler nozzles.

➤ Controller Installation

Rain Bird controllers have a 3-pin plug for easy connection to power. Low voltage wire as specified on the irrigation design is used for solenoid operation. This is run in the trenches to solenoids from controller. One wire is used from each valve to terminals on controller and the other wire is used as a common wire and is looped in series to each valve and then to a common terminal on controller. See image to right.

➤ Valves

Open each valve and check for leaks and proper coverage. If satisfactory, cover valves with valve box, fill in trenches and replace sod.

Now you can sit back and relax and watch your garden grow while being watered automatically with your Rain Bird irrigation system.

Sprinkler Installation Example

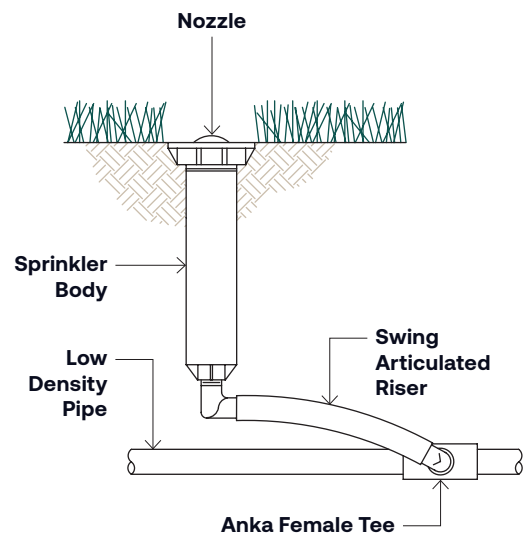

Controller Installation Example

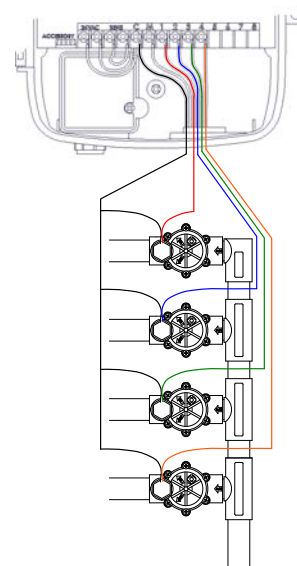

Contact

AUCKLAND

Office Address

221 Bush Road
Rosedale, Albany, North Shore
Auckland

Delivery Address

Auckland PO Box 33 780,
Takapuna, Auckland
P.+64 9 415 6151

CHRISTCHURCH

Office Address

58 Hammersmith Drive,
Wigram,
Christchurch 8042

Delivery Address

Christchurch PO Box 4419,
Christchurch 8140
P.+64 3 341 1048

<https://hydroflow.co.nz/products/irrigation>

irrigation@hydroflow.co.nz

HYDROFLOW

Irrigation

Hydroflow Distributors Ltd
221 Bush Road
Rosedale
Auckland 0632

hydroflow.co.nz

