

⊕ LA COUPLINGS

Since 1957, LA couplings, developed for direct connection of plain pipes, have been adopted by waterworks authorities, gas companies, contractors, civil aviation and shipping bureaus and the Ministry of Transport.

INDEX

Types and Connection of LA Couplings	2
LA Type	2
HI-LA Type	3
P-LA Type	4
Connection of LA Couplings for Dissimilar Pipes	5
Rubber Packings for LA Couplings	6
Applications of LA Couplings	7
Types and Dimensions of LA Couplings	8
Types and Connection of F-LA Couplings	10

Types and Applications of LA Couplings

Type	Applicable Fluid					
	Hot-dipped galvanized				Top-Coat (epoxy coated)	
	Water supply	Hot water (up to 60°C)	Air	Gas	Water supply	Gas
LA Coupling, LA Type	●	●	●	●	●	●
LA Coupling, HI-LA Type (with lock ring)	●	●	●	●	●	●
LA Coupling, P-LA Type (with lock ring)	●				●	
F-LA Coupling	●	●	●	●	●	●

Note: LA Couplings are applicable to the above-mentioned fluids provided that NBR packings are used.

Features

1. Easy connection

LA Couplings can be connected directly to plain pipes as they have a highly efficient sealing mechanism using special rubber packing. This eliminates threading, grooving and welding pipes. The special mechanism allows the length and angle of pipes to be adjusted easily and so speeds up installation work.

2. Total utilization of pipe strength

As pipes do not require threading to effect coupling up, the entire strength of the pipe is utilized, and this means greater pipe durability. Threaded connection can result in leakage through the screw section or breakage due to corrosion of the exposed threaded part. These problems are all prevented by using LA Couplings.

3. Highly resistant to expansion, contraction, vibration and deflection

LA Couplings are designed to give flexibility and to withstand a certain amount of expansion and contraction.

4. Easy connection with pipes of dissimilar materials

LA Couplings are used for the connection of pipes of dissimilar materials such as steel and PVC pipes, PVC and polyethylene pipes, steel and polyethylene pipes, etc. in piping for various plants, hot water piping for agricultural vinyl houses and farms, piping for sprinklers, temporary piping for construction sites as well as piping for machinery and equipment.

This is a unique features of LA Couplings. (Refer to page 5. Connection of LA Couplings for Dissimilar pipes.)

5. Excellent capability

LA Couplings are widely used for water, hot water, gas, air, and many other applications. They have earned an excellent reputation thanks to their high quality.

Applicable Pipes and Nominal Size of LA Couplings

Nominal Size	Applicable Pipe			Type of LA Coupling		
	Type of pipe	Nominal size, mm	O.D., mm	LA Type	HI-LA Type	P-LA Type
3/8	PVC pipe	10	15.0	●	/	/
	PVC pipe	13	18.0	●	●	/
	Steel pipe	10 (3/8)	17.3	●	●	/
	Polyethylene pipe	10	17.0	/	/	●
1/2	PVC pipe	16	22.0	●	/	/
	Steel pipe	15 (1/2)	21.7	●	●	/
	Polyethylene pipe	13	21.5	/	/	●
3/4	PVC pipe	20	26.0	●	●	/
	Steel pipe	20 (3/4)	27.2	●	●	/
	Polyethylene pipe	20	27.0	/	/	●
1	PVC pipe	25	32.0	●	●	/
	Steel pipe	25 (1)	34.0	●	●	/
	Polyethylene pipe	25	34.0	/	/	●
1 1/4	PVC pipe	30	38.0	●	●	/
	Steel pipe	32 (1 1/4)	42.7	●	●	/
	Polyethylene pipe	30	42.0	/	/	●
1 1/2	PVC pipe	40	48.0	●	●	/
	Steel pipe	40 (1 1/2)	48.6	●	●	/
	Polyethylene pipe	40	48.0	/	/	●
2	PVC pipe	50	60.0	●	●	/
	Steel pipe	50 (2)	60.5	●	●	/
	Polyethylene pipe	50	60.0	/	/	●
2 1/2	PVC pipe	65	76.0	●	/	/
	Steel pipe	65 (2 1/2)	76.3	●	●	/
	Polyethylene pipe	65	76.0	/	/	●
3	PVC pipe	75	89.0	●	/	/
	Steel pipe	80 (3)	89.1	●	●	/
	Polyethylene pipe	75	89.0	/	/	●

() indicates inch dimensions

How to Order

When ordering LA Couplings, the connecting pipes, nominal size, fluid and pressure should be specified. Dimension and material of rubber packing depends on the type of the pipe and fluid in some cases. The rubber packing, washer, lock ring and nut are available as separate items.

TYPES AND CONNECTION OF LA COUPLINGS (LA TYPE)

LA Type

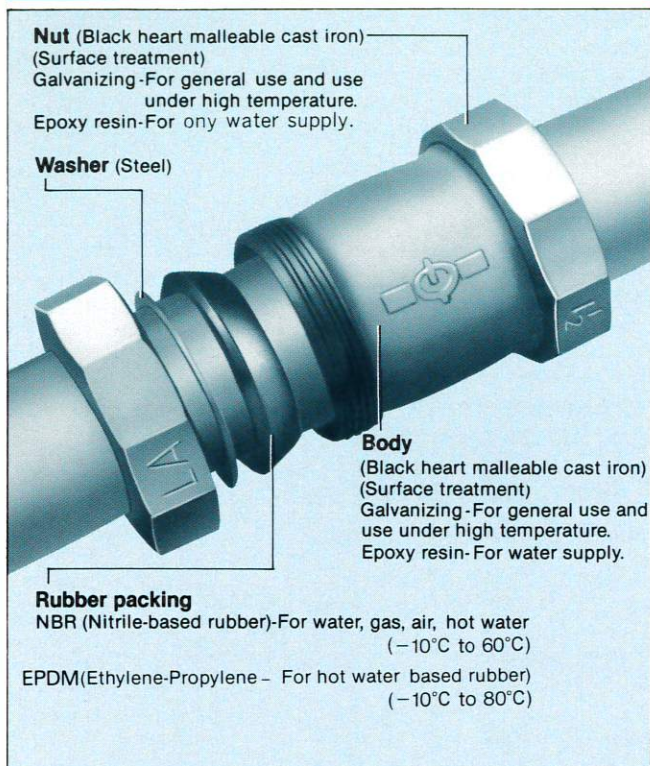

(Refer to RIKEN for special applications.)

As seen from the photo, LA type consists of the body, rubber packings, washers and nuts. In this type, the sealing effect on the fluid can be obtained by tightening the nut as this causes the highly elastic rubber packing to be pressed tightly against the surface of the pipe. Since the rubber packing exerts a large reaction force and frictional force on the internal face of the nut, the nut is held fast so that it will not loosen. Pipes should be fixed.

Applications:

For general use, water, supply, supply gas and hot water piping as well as other piping which requires some expansion and contraction.

Applicable Pipes:

JIS G3452 Carbon Steel Pipes for Ordinary Piping
JIS G3442 Galvanized Steel Pipes for Ordinary Piping
JIS K6741 Unplasticized Poly (Vinyl Chloride) (PVC-U) Pipes
JIS K6742 Unplasticized Poly (Vinyl Chloride) (PVC-U) Pipes for Water Works

Applicable Fluids and Working Pressure:

Applicable Fluid	Working pressure, MPa
Water, hot water	1 (Pipes should be fixed.)
Gas, air	0.3 (Pipes should be fixed.)

Available Nominal Size:

1/2 to 3

Note: Refer to RIKEN for applications other than buried piping.

Connection of LA Type

1. Setting procedure of each part and dimension A

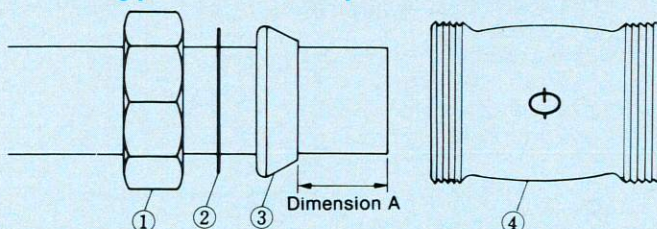

Each part should be set in numerical order as shown in the figure. At that time, rubber packing should be set conforming to dimension A as listed in the following table.

Nominal size	$\frac{3}{8}$, $\frac{1}{2}$, $\frac{3}{4}$, 1	$1\frac{1}{4}$, $1\frac{1}{2}$, 2	$2\frac{1}{2}$, 3
Dimension A, mm	15	20	25

2. Tightening of nuts and required torque

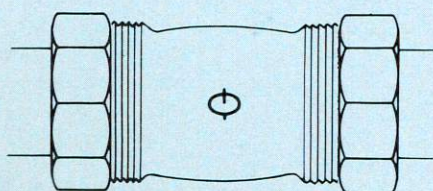

The nut should be tightened with a wrench according to the tightening torque as shown in the table.

Take care not to cause deterioration of rubber packing by excessive tightening torque.

Nominal size	Tightening Torque, N·m (kgf·m)
$\frac{3}{8}$	39 (4)
$\frac{1}{2}$	39 (4)
$\frac{3}{4}$	59 (6)
1	69 (7)
$1\frac{1}{4}$	78 (8)
$1\frac{1}{2}$	88 (9)
2	98 (10)
$2\frac{1}{2}$	127 (13)
3	147 (15)

TYPES AND CONNECTION OF LA COUPLINGS (HI-LA TYPE)

HI-LA Type

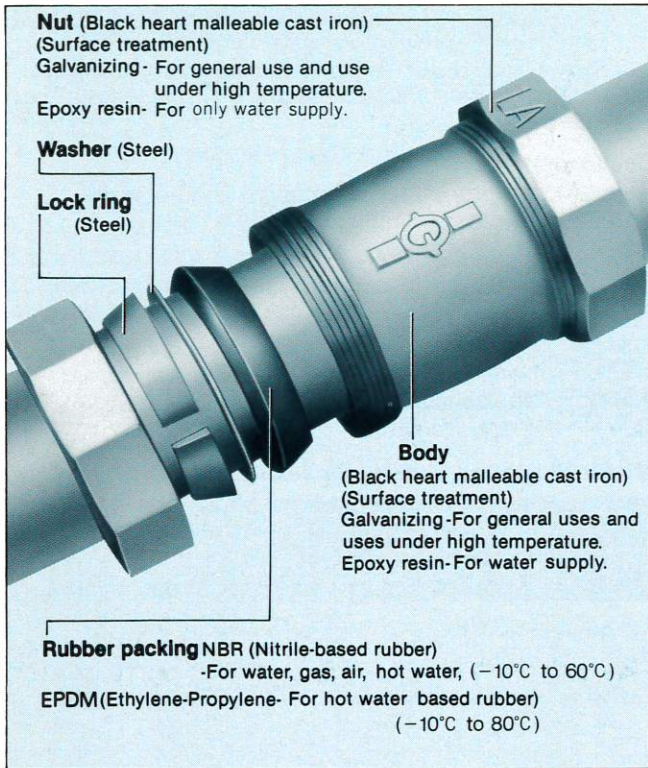

HI-LA type is one variation of the LA type with lock rings provided to prevent pipes from slipping off.

Applications:

General-use, water, gas, hot water and air as well as piping for vessels, vehicles, engine rooms, compressors, sprinklers, buildings and bridges. Also buried piping which may be subject to partial subsidence of ground or localized load.

Applicable Pipes:

JIS G3452 Carbon Steel Pipes for Ordinary Piping
JIS G3442 Galvanized Steel Pipes for Ordinary Piping
JIS K6741 Unplasticized Poly (Vinyl Chloride) (PVC-U) Pipes
JIS K6742 Unplasticized Poly (Vinyl Chloride) (PVC-U) Pipes for Water Works.

Applicable Fluids and Working Pressure:

Applicable Fluid	Working pressure, MPa
Water, hot water	1
Gas, air	0.3

Available Nominal Size:

1/2 to 3

Connection of HI-LA Type

1. Setting procedure of each part and dimension A

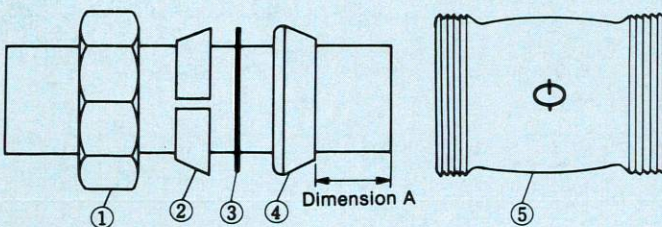

Each part should be set in numerical order as shown in the figure. At that time, rubber packing should be set conforming to dimension A as listed in the following table.

Nominal size	3/8, 1/2, 3/4, 1	1 1/4, 1 1/2, 2	2 1/2, 3
Dimension A, mm	15	20	25

2. Tightening of nuts and required torque

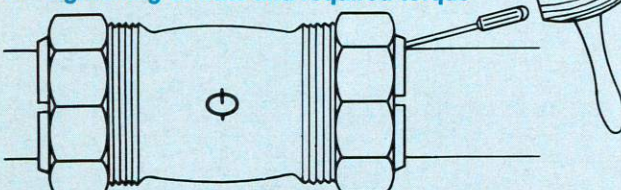

The nut should be tightened with a wrench according to the tightening torque as shown in the table. Take care not to cause deterioration of rubber packing by excessive tightening torque.

Driving of lock ring

The lock ring should be driven at last tightening position of piping system. After the nut is tightened slightly, knock the edge of the lock ring with the tip of the driver, then tighten the nut securely.

Nominal size	Tightening Torque, N·m (kgf·m)
3/8	69 (7)
1/2	69 (7)
3/4	78 (8)
1	98 (10)
1 1/4	118 (12)
1 1/2	157 (16)
2	196 (20)
2 1/2	225 (23)
3	245 (25)

3. Tightening of single lock ring

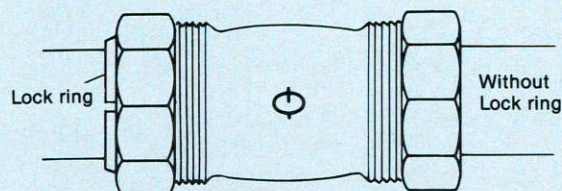

Tighten HI-LA type side according to tightening torque for HI-LA type, then tighten LA type side according to tightening torque for LA type.

TYPES AND CONNECTION OF LA COUPLINGS (P-LA TYPE)

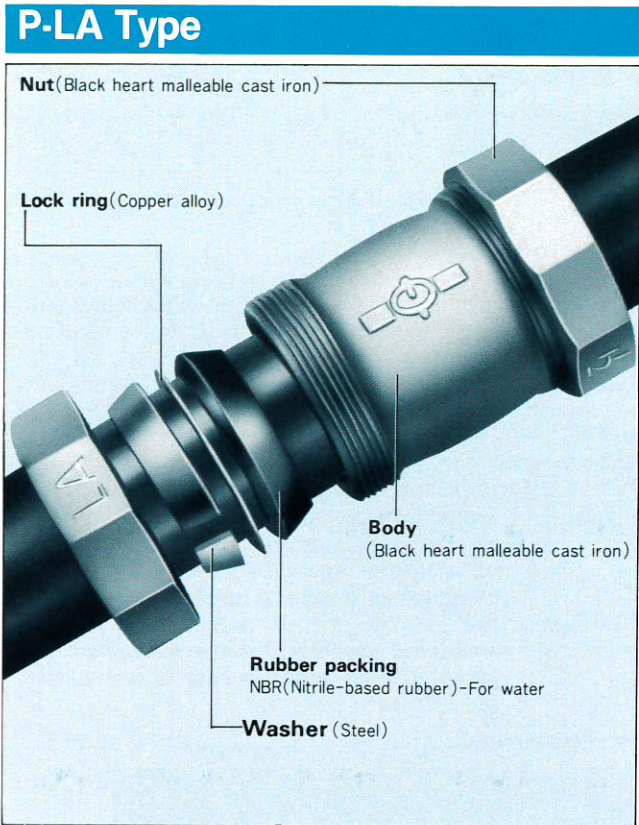

This type has been developed exclusively for polyethylene pipes, and is provided with lock rings to prevent pipes from slip-off. The lock rings are designed so that their edges will bite ideally into polyethylene pipes, and this means that lock rings prevent slip-off without reducing the strength of polyethylene pipes which is required to withstand external forces as well as internal pressure. These advantages contribute to reliability of piping system, good workability and labor saving.

Applications:

Water supply

Applicable Pipes:

JIS K6762 Double Wall Polyethylene Pipes for Water Supply.

Applicable Fluids and Working Pressure:

Applicable Fluid	Working Pressure, MPa
Water	0.75

Note: Working pressure varies with specified type of the pipe.

Available Nominal Size:

1/2 to 2

Note: Refer to RIKEN for applications other than buried piping.

Connection of P-LA Type

1. Setting procedure of each part and dimension A

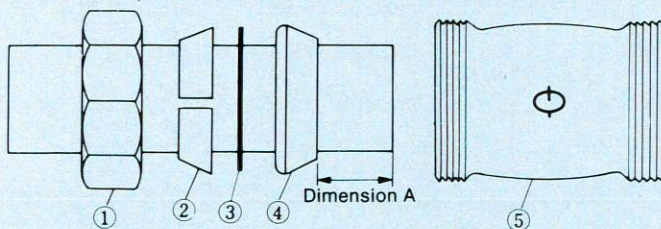

Each part should be set in numerical order as shown in the figure. At that time, rubber packing should be set conforming to dimension A as listed in the following table.

Nominal size	3/8, 1/2, 3/4, 1	1 1/4, 1 1/2, 2
Dimension A, mm	15	20

2. Tightening of nuts

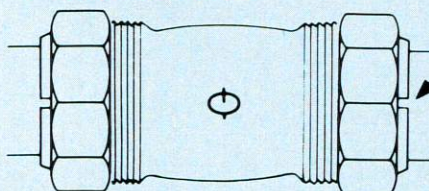

Tighten the nut by hand, close the gap of the lock ring by tightening with a wrench, then tighten an additional half turn.

3. Tightening of single lock ring torque of LA type (In case of dissimilar pipes)

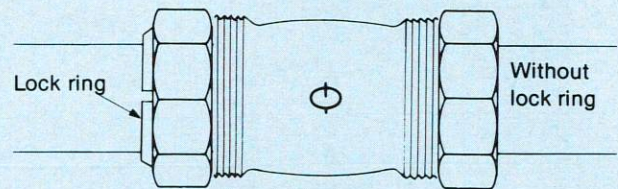

Tighten P-LA type side first, then tighten the other nut without lock ring (LA type)

CONNECTION OF LA COUPLINGS FOR DISSIMILAR PIPES

Universal connection for dissimilar pipes just by changing parts.....

When LA couplings are used for connection of dissimilar pipes such as steel and PVC pipes, PVC and polyethylene pipes, polyethylene and steel pipes, etc., please pay attention to the following:

- (1) Bodies of LA, HI-LA and P-LA types are common.
- (2) LA and HI-LA types are designed for steel and PVC pipes, while P-LA type is designed exclusively for polyethylene pipes.
- (3) Outside diameters of PVC, steel and polyethylene pipes may differ considerably from the nominal diameter. Therefore, the washer, rubber packing, nut and lock ring should be selected properly according to the interchangeability and size of each part listed in the following table. Parts marked with  are common. Other parts should be replaced before use.

● Connection between Steel Pipe and PVC Pipe

LA Type : In case of nominal size 3/8" (steel) × 10mm (PVC), 1" (steel) × 25mm (PVC) and 1 1/4" (steel) × 30mm (PVC), the rubber packing, washer and nut on one side should be replaced for PVC pipes. No such rearrangement is required for other nominal sizes.

HI-LA Type: For all nominal size, the nut (except nominal size 16mm) and lock ring on one side should be rearranged for PVC pipes. Also, the rubber packing and washer should be rearranged for PVC pipes in case of nominal size 3/8" (steel) × 10mm (PVC), 1" (steel) × 25mm (PVC) and 1 1/4" (steel) × 30mm (PVC).

● Connection between PVC Pipe and Polyethylene Pipe









































In this case, it is efficient to use P-LA type by rearranging each part on one side to LA or HI-LA type for PVC pipes. When LA or HI-LA type is used, rearrangement should be made referring to interchangeability listed in the following table.

● Connection between Polyethylene Pipe and Steel Pipe

LA Type : For all nominal size, the nut and lock ring on one side should be rearranged for polyethylene pipes. Also, the washer should be replaced in case of nominal size 50mm.

HI-LA Type: For all nominal sizes, only the lock ring should be rearranged. Also, the washer should be rearranged in case of nominal size 50mm.

The following combination should be selected to ensure maximum performance

Nominal size of LA Coupling	Applicable Pipe			Interchangeability and Dimension of Each Part					
				I.D. of Rubber Packing, mm	I.D. of Washer, mm	I.D. of Nut, mm		I.D. of Lock Ring, mm	
	Type of pipes	Nominal size, mm (in.)	O.D., mm			LA Type	HI-LA Type P-LA Type	HI-LA Type	P-LA Type
3/8	PVC Pipe	10	15.0				/	/	/
	PVC Pipe	13	18.0						/
	Steel Pipe	10(3/8)	17.3						/
	Polyethylene Pipe	10	17.0			/		/	
1/2	PVC Pipe	16	22.0						/
	Steel Pipe	15(1/2)	21.7						/
	Polyethylene Pipe	13	21.5			/		/	
3/4	PVC Pipe	20	26.0						/
	Steel Pipe	20(3/4)	27.2						/
	Polyethylene Pipe	20	27.0			/		/	
1	PVC Pipe	25	32.0						/
	Steel Pipe	25(1)	34.0						/
	Polyethylene Pipe	25	34.0			/		/	
1 1/4	PVC Pipe	30	38.0						/
	Steel Pipe	32(1 1/4)	42.7						/
	Polyethylene Pipe	30	42.0			/		/	
1 1/2	PVC Pipe	40	48.0						/
	Steel Pipe	40(1 1/2)	48.6						/
	Polyethylene Pipe	40	48.0			/		/	
2	PVC Pipe	50	60.0						/
	Steel Pipe	50(2)	60.5						/
	Polyethylene Pipe	50	60.0			/		/	
2 1/2	PVC Pipe	65	76.0						/
	Steel Pipe	65(2 1/2)	76.3						/
	Polyethylene Pipe	65	76.0			/		/	
3	PVC Pipe	80	89.0						/
	Steel Pipe	80(3)	89.1						/
	Polyethylene Pipe	75	89.0			/		/	

RUBBER PACKINGS FOR LA COUPLINGS

Types of Rubber Packings and Applicable Fluids (Refer to RIKEN for details of applications.)

- Three types of rubber packing materials are available for each nominal size according to applicable fluids.

Material	Marking	Applicable Fluid	Working Temperature, °C
NBR (Nitrile rubber)	G	Water, gas, air, hot water}(up to 60°C)	-10~60
EPDM (Ethylene-propylene rubber)	EP	Hot water	-10~80

- Reference data for material selection

Application			Rubber Packing Material	
Fluid	Concentration, %	Temperature, °C	NBR	EPDM
Water, hot water	100	R.T.	◎ (× above 60°C)	◎ (-10°C to 80°C)
Air	100	60	◎	◎ (× with oil)
City gas	100	R.T.	◎	○
Propane gas	100	R.T.	◎	×
Natural gas	100	R.T.	◎	×

◎ Excellent ○ Good × Not recommended (Refer to RIKEN for details)

Marking of Rubber Packings

As shown in the figure, the applicable nominal size, material, etc. are marked by embossed letters on the rubber packing.

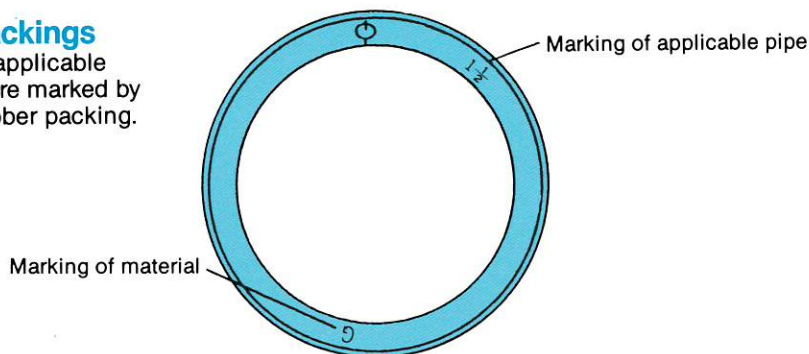

Nominal size. of LA Type.	Nominal size. of Rubber Packing.	Applicable Pipe, Pipe Nominal Size						Mark of Nominal Size		
		Steel Pipe		PVC Pipe	PVC Pipe for Waterworks, mm	Polyethylene Pipe, in.	Polyethylene Pipe for Waterworks, mm	For Steel Pipe	For PVC Pipe.	For Polyethylene Pipe.
			mm	mm						
3/8	3/8	3/8	10	13	13	10	10	3/8	13	10
1/2	1/2	1/2	15	16	—	13	13	1/2	16	13
3/4	3/4	3/4	20	20	20	20	20	3/4	20	20
1	PVC 25mm	—	—	25	25	—	—	—	25	—
	1	1	25	—	—	25	25	1	—	25
1 1/4	PVC 30mm	—	—	30	30	—	—	—	30	—
	1 1/4	1 1/4	32	—	—	30	30	1 1/4	—	30
1 1/2	1 1/2	1 1/2	40	40	40	40	40	1 1/2	40	40
2	2	2	50	50	50	50	50	2	50	50
2 1/2	2 1/2	2 1/2	65	—	—	—	—	2 1/2	—	—
3	3	3	80	—	—	—	—	3	—	—

TYPES AND DIMENSIONS OF LA COUPLINGS

● **Types of LA Couplings** (Other types and dimensions are available on request).

Type	LA Coupling				
	LA Type	HI-LA Type			P-LA Type
		With lock ring on one outlet	With lock ring on both outlets	With lock ring on three outlets	
Socket (S)	○ ○	A	AB		○
Long socket (SSS)	○ ○	A	AB		○
Elbow (L)	○ ○	A	AB		○
45° Elbow (45° L)	○ ○	A	AB		○
Tee with threaded branch outlet (T)	○ ○	A	AB		○
Reducing tee with threaded branch outlet (RT)	○ ○	A	AB		○
Tee (NT)	○ ○	A	AB, AC	ABC	○
Adapter, male threaded (AP)	○ ○	A			○
Reducing adapter, male threaded (RAP)	○ ○	A			○
Adapter, female threaded (AQ)	○ ○	A			○
Reducing adapter, female threaded (RAQ)	○ ○	A			○

A : with one lock ring	Socket	Elbow	Tee with threaded branch outlet.
AB, AC : with two lock rings			
ABC : with three lock rings			

● **Nut**

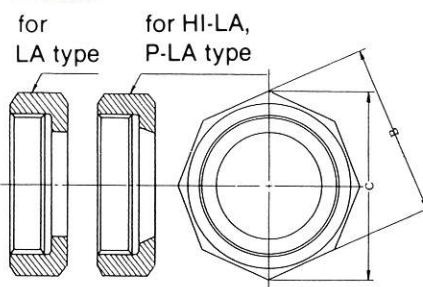

Nominal size of nut	B Width across flats, mm	C Approx. diagonal dimension, mm	Shape of nut
3/8	37	40	Octagonal
1/2	42	45.5	Octagonal
3/4	49	53	Octagonal
1	58	62.8	Octagonal
1 1/4	66	69.4	Decagonal
1 1/2	73	76.8	Decagonal
2	87	91.5	Decagonal
2 1/2	108	113.6	Decagonal
3	123	129.3	Decagonal

○ Taper Pipe Threads

Dimensions of LA Couplings (Max 2inch for P-LA)

SOCKET (S)	Nominal Size	LA Type		HI-LA Type	P-LA Type	
		L Approx	A	L Approx	A	
 	3/8	64	50	75	50	
	1/2	69	55	80	55	
	3/4	75	60	85	60	
	1	80	65	90	65	
	1 1/4	86	70	96	70	
	1 1/2	91	75	102	75	
	2	97	80	112	80	
	2 1/2	110	90	124	90	
	3	120	100	136	100	

LONG SOCKET (SSS)	Nominal Size	LA Type		HI-LA Type	P-LA Type	
		L Approx	A	L Approx	A	
 	1/2	101.5	87.5	112.5	87.5	
	3/4	109	94	119	94	
	1	115	100	125	100	
	1 1/4	122	106	132	106	
	1 1/2	128.5	112.5	139.5	112.5	
	2	136	119	151	119	

ELBOW (L)

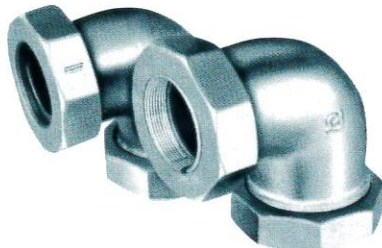
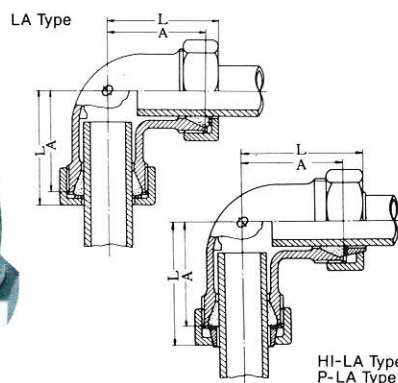
Nominal Size	LA Type		HI-LA Type	P-LA Type
	L Approx	A	L Approx	A
1/2	49	42	54	42
3/4	55.5	48	60	48
1	61.5	54	66	54
1 1/4	70	62	75	62
1 1/2	77	69	82	69
2	87.5	79	95.5	79
2 1/2	97	87	104	87
3	105	95	112	95

45° ELBOW (45°L)

Nominal Size	LA Type		HI-LA Type	P-LA Type
	L Approx	A	L Approx	A
1 1/2	70	57	70	57
2	83.5	67	83.5	67

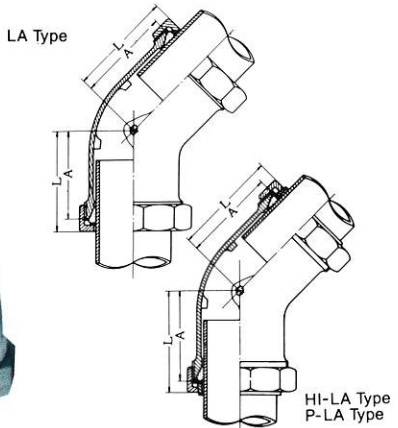
TEE WITH THREADED BRANCH OUTLET (T)

Nominal Size	LA Type				HI-LA Type				P-LA Type			
	L Approx	A	C	d (Rc)	L Approx	A	C	d (Rc)	L Approx	A	C	d (Rc)
1/2	85	71	29	1/2	96	71	29	1/2	96	71	29	1/2
3/4	97	82	34	3/4	107	82	34	3/4	107	82	34	3/4
1	106	91	40	1	116	91	40	1	116	91	40	1
1 1/4	122	106	46.5	1 1/4	132	106	46.5	1 1/4	132	106	46.5	1 1/4
1 1/2	133	117	51	1 1/2	144	117	51	1 1/2	144	117	51	1 1/2
2	150	133	59	2	165	133	59	2	165	133	59	2
2 1/2	178	158	71.5	2 1/2	192	158	71.5	2 1/2	192	158	71.5	2 1/2
3	191	171	81	3	205	171	81	3	205	171	81	3

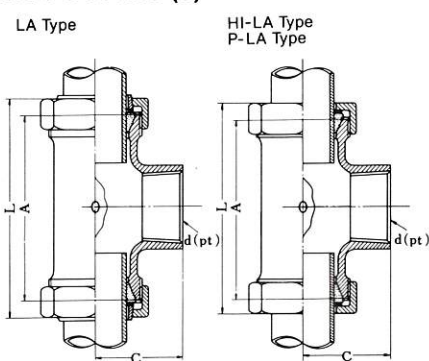
REDUCING TEE WITH THREADED BRANCH OUTLET (RT)

Nominal Size	LA Type				HI-LA Type				P-LA Type			
	L Approx	A	C	d	L Approx	A	C	d	L Approx	A	C	d
3/4 x 1/2	90.5	76	32	1/2	101	76	32	1/2	101	76	32	1/2
1 x 1/2	90.5	81	36	1/2	106	81	36	1/2	106	81	36	1/2
1 x 3/4	102	87	38	3/4	112	87	38	3/4	112	87	38	3/4
1 1/4 x 1/2	101	86	40	1/2	112	86	40	1/2	112	86	40	1/2
1 1/4 x 3/4	107.5	92	42	3/4	118	92	42	3/4	118	92	42	3/4
1 1/4 x 1	113.5	98	44	1	124	98	44	1	124	98	44	1
1 1/2 x 1/2	106	91	43.5	1/2	118	91	43.5	1/2	118	91	43.5	1/2
1 1/2 x 3/4	112.5	97	45.5	3/4	124	97	45.5	3/4	124	97	45.5	3/4
1 1/2 x 1	118.5	103	47.5	1	130	103	47.5	1	130	103	47.5	1
1 1/2 x 1 1/4	127	111	50	1 1/4	138	111	50	1 1/4	138	111	50	1 1/4
2 x 1/2	111.5	96	50	1/2	128	96	50	1/2	128	96	50	1/2
2 x 3/4	118	102	52	3/4	134	102	52	3/4	134	102	52	3/4
2 x 1	124	108	54	1	140	108	54	1	140	108	54	1
2 x 1 1/4	132.5	116	56.5	1 1/4	148	116	56.5	1 1/4	148	116	56.5	1 1/4
2 x 1 1/2	132.5	122	57.5	1 1/2	154	122	57.5	1 1/2	154	122	57.5	1 1/2
2 1/2 x 2	190	170	70	2	206	170	70	2	206	170	70	2
3 x 2	200	180	77	2	216	180	77	2	216	180	77	2

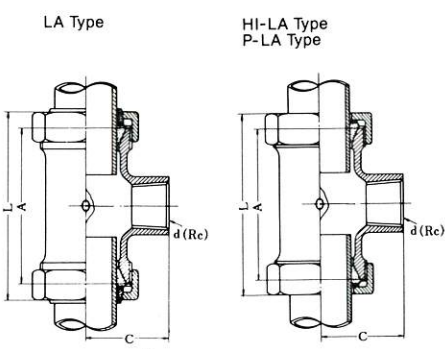
DIMENSIONS OF LA COUPLINGS

TEE (NT)

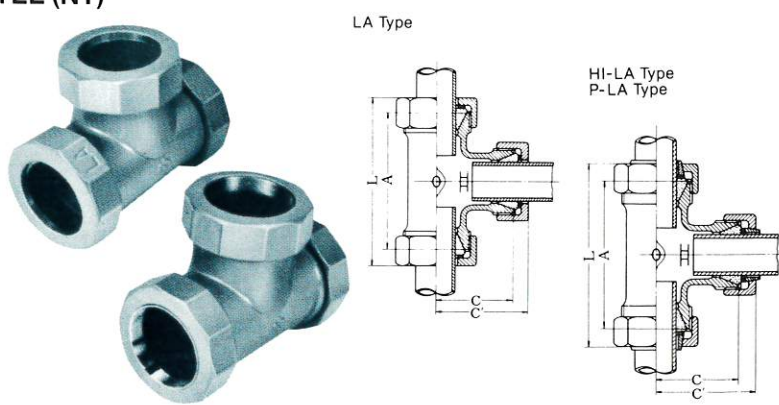

Nominal Size	LA Type				HI-LA Type		P-LA Type	
	L Approx	A	C	C'	L Approx	A	C	C'
3/8	77	63	35	42	87	63	35	47
1/2	85	71	39	46	95	71	39	51
3/4	97	82	44	51.5	106	82	44	56
1	106	91	50	57.5	115	91	50	62
1 1/4	122	106	56.5	64.5	132	106	56.5	70
1 1/2	133	117	63	71	143	117	63	76
2	150	133	71	79.5	165	133	71	87

**ADAPTER, MALE THREADED (AP)
REDUCING ADAPTER, MALE THREADED (RAP)**

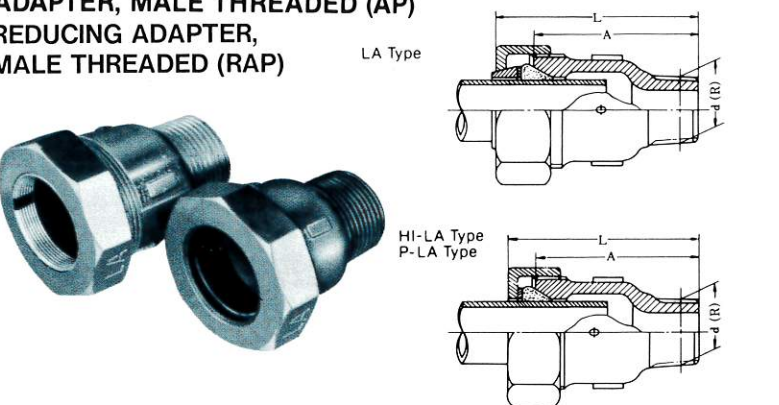

Nominal Size	LA Type			HI-LA Type		P-LA Type	
	L Approx	A	d	L Approx	A	d	(R)
3/8 x 1/2	57	50	1/2	64	50	1/2	1/2
1/2	61	54	1/2	66	54	1/2	1/2
3/4	61.5	56	3/4	68	56	3/4	3/4
1	69.5	62	1	74	62	1	1
1 1/4	72	64	1 1/4	77	64	1 1/4	1 1/4
1 1/2	73	65	1 1/2	78	65	1 1/2	1 1/2
2	82	73.5	2	89	73.5	2	2
2 1/2	93	83	2 1/2	100	83	2 1/2	2 1/2
3	99	89	3	106	89	3	3

**ADAPTER, FEMALE THREADED (AQ)
REDUCING ADAPTER, FEMALE THREADED (RAQ)**

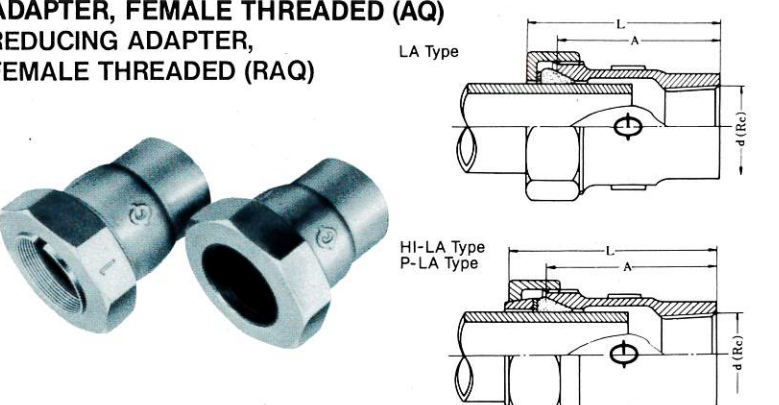

Nominal Size	LA Type			HI-LA Type		P-LA Type	
	L Approx	A	d (Rc)	L Approx	A	d (Rc)	(Rc)
3/8 x 1/2	55	48	1/2	60	48	1/2	1/2
1/2	57	50	1/2	62	50	1/2	1/2
3/4	60	53	3/4	65	53	3/4	3/4
1	66	58.5	1	70.5	58.5	1	1
1 1/4	70	62	1 1/4	75	62	1 1/4	1 1/4
1 1/2	72.5	64.5	1 1/2	77.5	64.5	1 1/2	1 1/2
2	80.5	72	2	88.0	72	2	2
2 1/2	91	81	2 1/2	98	81	2 1/2	2 1/2
3	93.5	83.5	3	100.5	83.5	3	3