



PT3002 Flow Sensor Transmitter
Installation and Programming Instructions
Instrucciones de instalación y programación



Contents

Wiring Instructions	3
For Use As A High Flow Shut Off Device With A Stand Alone Controller.....	4
Using a Normally Closed Master Valve	4
Using a Normally Open Master Valve	4
For Output to Maxicom®	5
Initial Powerup	6
Display and Key Pad	6
General Programming	6
Step 1	6
Step 2a	9
Step 2b	11
Resetting the 3002 After a High Flow Occurrence	13
Resetting the 3002 To Zero Total Flow Readings	13
Appendix A	
Appendix B	

Wiring Instructions

NOTE: Refer to the PT3002 Flow Monitor and NEMACAB Installation sheet for more detailed instructions.

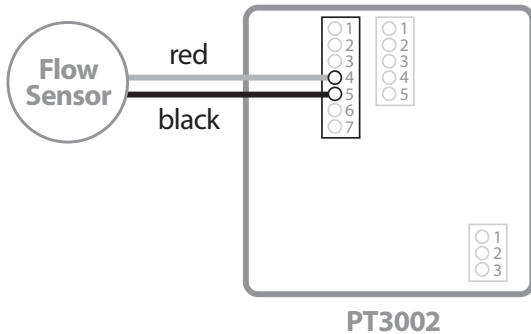

Wire red wire from flow sensor to terminal four on terminal block with seven terminals. Wire black wire from flow sensor to terminal five on terminal block with seven terminals. See wiring diagram label on side of PT3002.

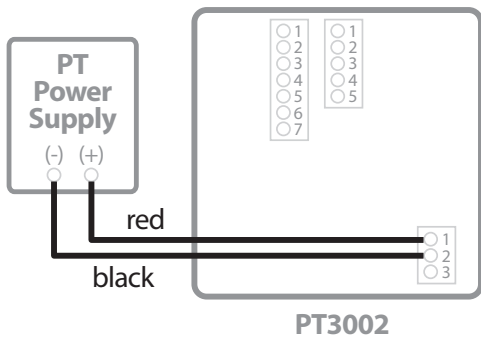

Wire the red lead (+) from the PT Power Supply to the terminal one on the three port terminal block. Wire the black / white (-) wire to terminal two of the three port terminal block.

Wiring Instructions (cont.)

For Use As A High Flow Shut Off Device With A Stand Alone Controller

Using a Normally Closed Master Valve

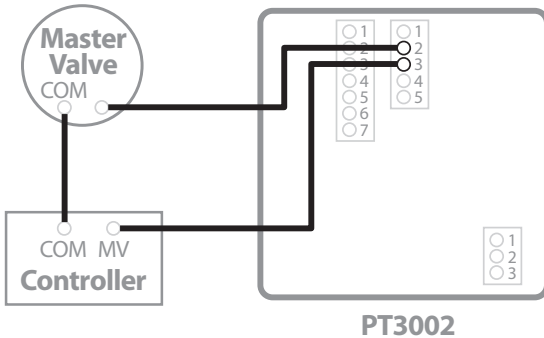

Wire one leg of the master valve solenoid wire to the Relay 1 NC 2 terminal. Wire the Relay 1 COM 3 terminal to the master valve terminal in the controller.

Note: Wire master valve common to controller common as in any normal installation.

Using a Normally Open Master Valve

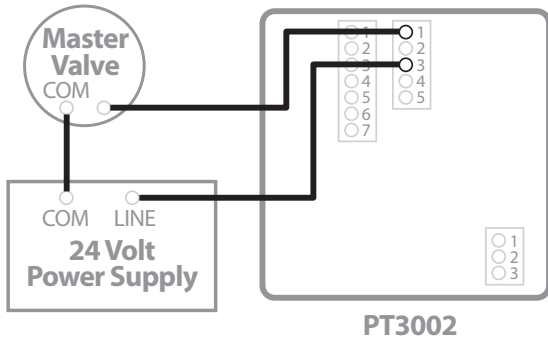

Wire one leg of the master valve solenoid wire to the Relay 1 NO 1 terminal. Wire the second leg of the solenoid to an auxiliary 24 volt power supply. Wire the Relay 1 COM 3 to the other leg of the auxiliary power supply. When a high flow condition occurs the internal relay closes, powering the normally open master valve and closing it.

For Output to Maxicom® or Site Control

(complete step 1 on pages 6 to 8 and step 2b on pages 11 to 12)

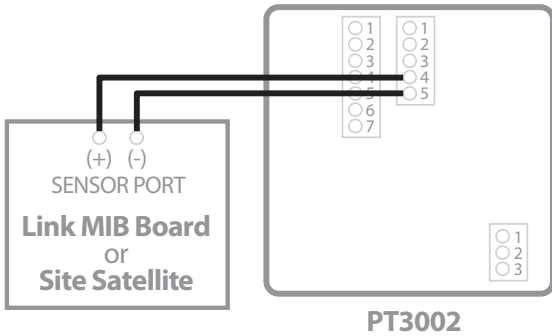

Wire the Pulse 1 Out terminal four to the positive (+) terminal of the sensor port on a link MIB board or Site Satellite. Wire Pulse 2 Out terminal five to the negative (-) terminal of the sensor port on a link MIB board or Site Satellite.

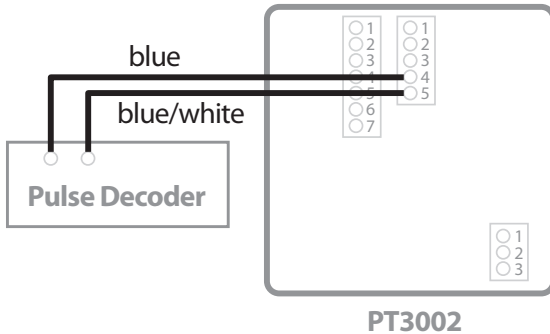

Wire the Pulse 1 Out terminal four to the blue wire of a pulse decoder if using two wire communications between CCU and satellite Controller. Wire Pulse 2 Out terminal five to the blue / white wire of a pulse decoder.

Initial Powerup



Plug the PT3002 Flow Monitor power supply into a 120 VAC electrical outlet.

When the PT3002 is first powered up, it runs through internal self checks, while displaying "PT3002 DIC Initializing." At the end of this cycle its normal display will appear.

Display and Key Pad

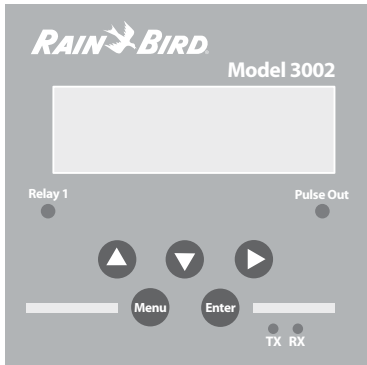

- Menu**
 - 1-Switch to main menu
 - 2-Backward/Previous menu
- Enter**
 - 1-Save value
 - 2-Forward/Next menu
- ▲**
 - 1-Select Menu option
 - 2-Increase numerical value
- ▼**
 - 1-Select Menu option
 - 2-Decrease numerical value
- ▶**
 - 1-Select Menu option
 - 2-Move cursor to the right

General Programming

Step 1

1. Press MENU to enter Programming Mode. Press ▼ to go to the Password Screen.

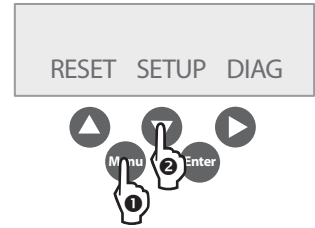

2. Use the arrow keys to enter a 4 digit password then press ENTER OR press ENTER to bypass using a password.

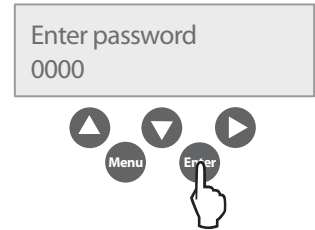

3. At the Setup menu, press ▶ to go to the Flow 1 Setup Screen.

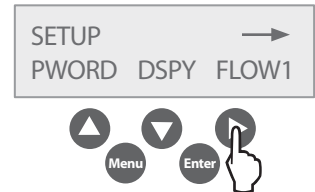

4. Press ▲ to go to the Flow 1 Rate Screen.

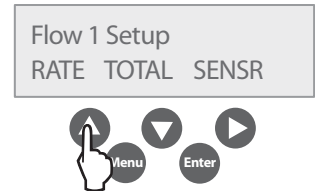

5. Press ▲ to Set Units.

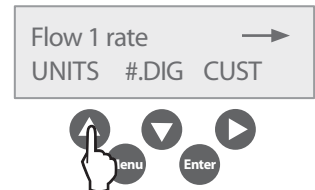

6. Set UNITS for GPM* by using ▲ or ▼ then press ENTER (the PT3002 saves the setting).
(Note: GPM used as an example throughout this manual.)

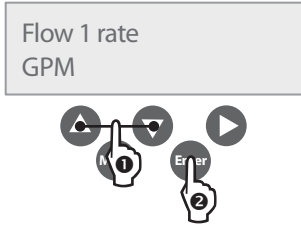

7. Press MENU once to go to the Flow 1 Setup Screen.

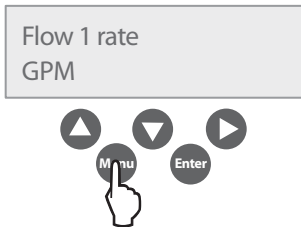

8. Press ▼ to Set TOTAL.

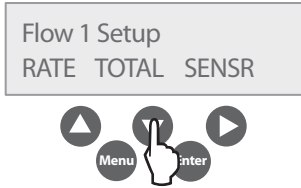

9. Press ▲ to Set UNITS.

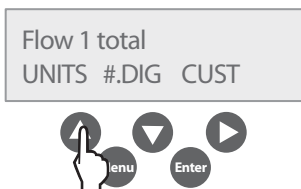

10. Set UNITS for gal by using ▲ or ▼ then press ENTER (the PT3002 saves the setting)

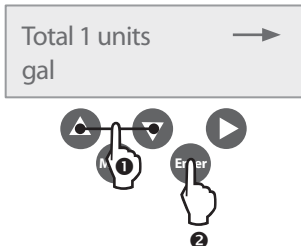

11. Press MENU twice to go to the Flow 1 Setup Screen.

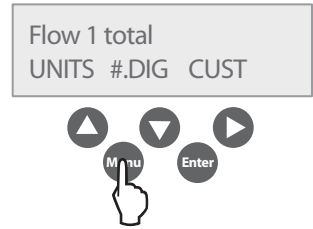

12. Press ► to Set SENSOR.

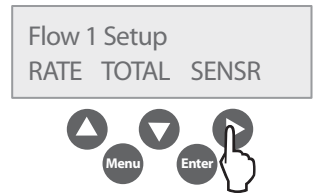

13. Press ▲ to Set TYPE.

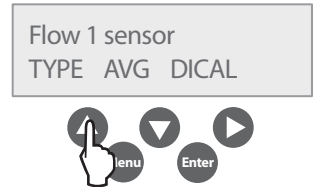

14. Press ▲ or ▼ until "Pulse -DI" appears, then press ENTER. The PT3002 saves the setting and brings you back to the screen below

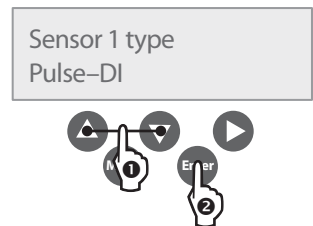

15. Press ► to Set DICAL.

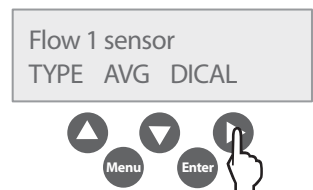



PT3002 Flow Sensor Transmitter
Installation and Programming Instructions
Instrucciones de instalación y programación



Contents

Wiring Instructions	3
For Use As A High Flow Shut Off Device With A Stand Alone Controller.....	4
Using a Normally Closed Master Valve	4
Using a Normally Open Master Valve	4
For Output to Maxicom®	5
Initial Powerup	6
Display and Key Pad	6
General Programming	6
Step 1	6
Step 2a	9
Step 2b	11
Resetting the 3002 After a High Flow Occurrence	13
Resetting the 3002 To Zero Total Flow Readings	13
Appendix A	
Appendix B	

Wiring Instructions

NOTE: Refer to the PT3002 Flow Monitor and NEMACAB Installation sheet for more detailed instructions.

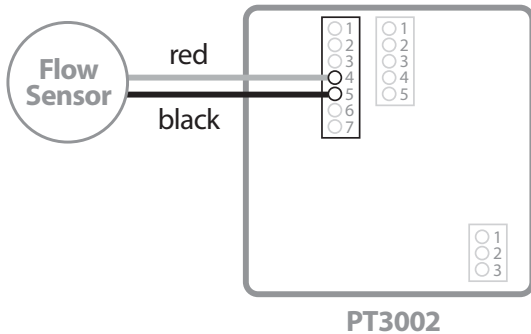

Wire red wire from flow sensor to terminal four on terminal block with seven terminals. Wire black wire from flow sensor to terminal five on terminal block with seven terminals. See wiring diagram label on side of PT3002.

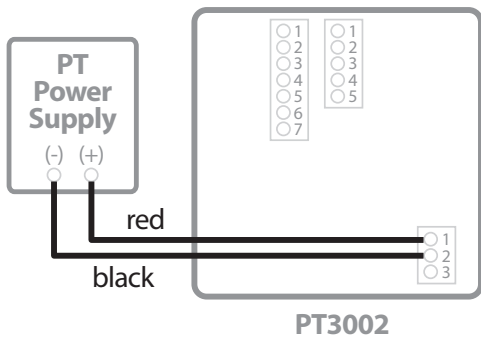

Wire the red lead (+) from the PT Power Supply to the terminal one on the three port terminal block. Wire the black / white (-) wire to terminal two of the three port terminal block.

Wiring Instructions (cont.)

For Use As A High Flow Shut Off Device With A Stand Alone Controller

Using a Normally Closed Master Valve

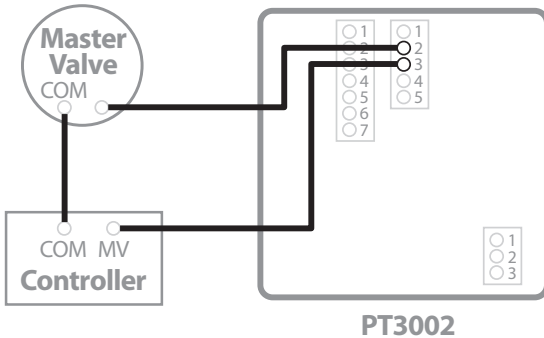

Wire one leg of the master valve solenoid wire to the Relay 1 NC 2 terminal. Wire the Relay 1 COM 3 terminal to the master valve terminal in the controller.

Note: Wire master valve common to controller common as in any normal installation.

Using a Normally Open Master Valve

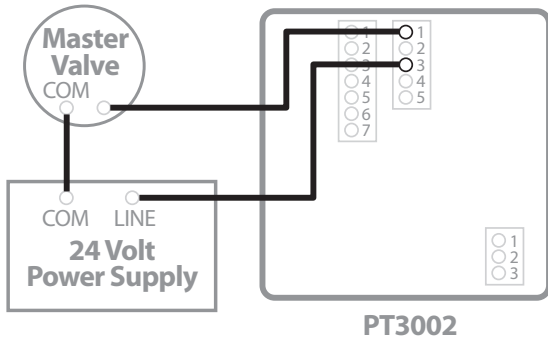

Wire one leg of the master valve solenoid wire to the Relay 1 NO 1 terminal. Wire the second leg of the solenoid to an auxiliary 24 volt power supply. Wire the Relay 1 COM 3 to the other leg of the auxiliary power supply. When a high flow condition occurs the internal relay closes, powering the normally open master valve and closing it.

For Output to Maxicom® or Site Control

(complete step 1 on pages 6 to 8 and step 2b on pages 11 to 12)

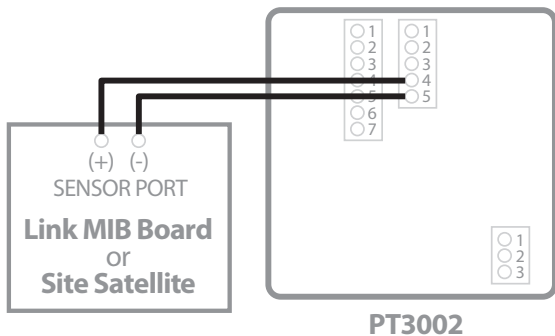

Wire the Pulse 1 Out terminal four to the positive (+) terminal of the sensor port on a link MIB board or Site Satellite. Wire Pulse 2 Out terminal five to the negative (-) terminal of the sensor port on a link MIB board or Site Satellite.

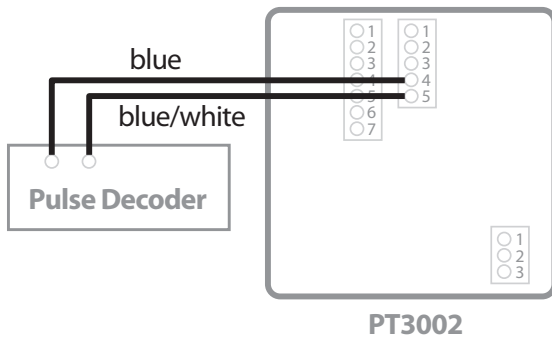

Wire the Pulse 1 Out terminal four to the blue wire of a pulse decoder if using two wire communications between CCU and satellite Controller. Wire Pulse 2 Out terminal five to the blue / white wire of a pulse decoder.

Initial Powerup



Plug the PT3002 Flow Monitor power supply into a 120 VAC electrical outlet.

When the PT3002 is first powered up, it runs through internal self checks, while displaying "PT3002 DIC Initializing." At the end of this cycle its normal display will appear.

Display and Key Pad

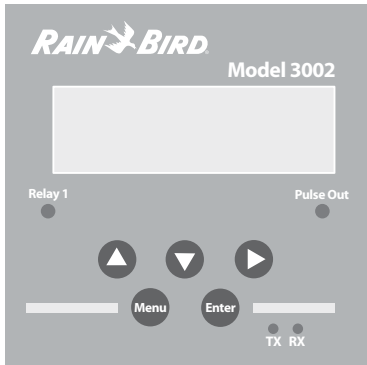

- Menu**
 - 1-Switch to main menu
 - 2-Backward/Previous menu
- Enter**
 - 1-Save value
 - 2-Forward/Next menu
- ▲**
 - 1-Select Menu option
 - 2-Increase numerical value
- ▼**
 - 1-Select Menu option
 - 2-Decrease numerical value
- ▶**
 - 1-Select Menu option
 - 2-Move cursor to the right

General Programming

Step 1

1. Press MENU to enter Programming Mode. Press ▼ to go to the Password Screen.

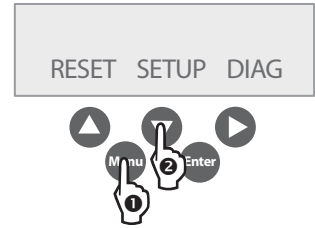

2. Use the arrow keys to enter a 4 digit password then press ENTER OR press ENTER to bypass using a password.

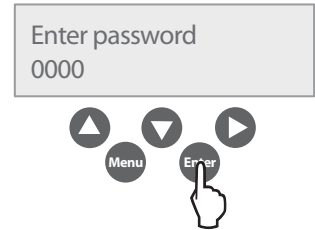

3. At the Setup menu, press ▶ to go to the Flow 1 Setup Screen.

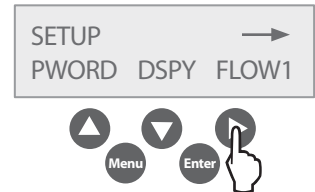

4. Press ▲ to go to the Flow 1 Rate Screen.

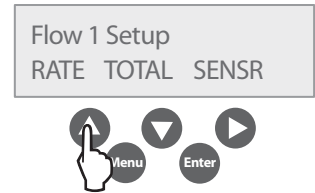

5. Press ▲ to Set Units.

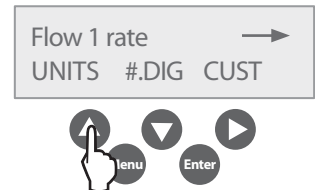

6. Set UNITS for GPM* by using ▲ or ▼ then press ENTER (the PT3002 saves the setting).
(Note: GPM used as an example throughout this manual.)

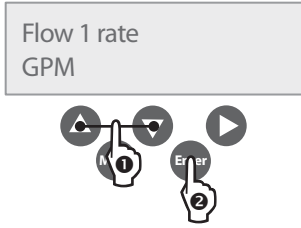

7. Press MENU once to go to the Flow 1 Setup Screen.

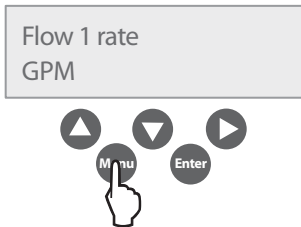

8. Press ▼ to Set TOTAL.

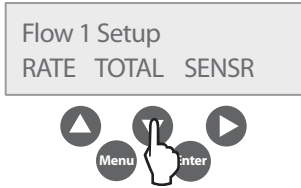

9. Press ▲ to Set UNITS.

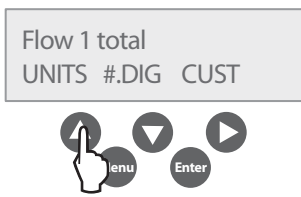

10. Set UNITS for gal by using ▲ or ▼ then press ENTER (the PT3002 saves the setting)

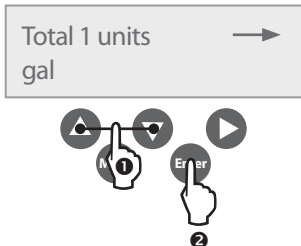

11. Press MENU twice to go to the Flow 1 Setup Screen.

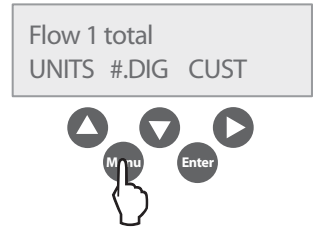

12. Press ► to Set SENSOR.

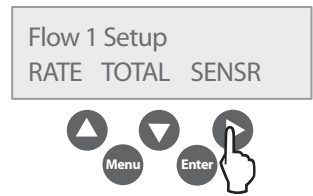

13. Press ▲ to Set TYPE.

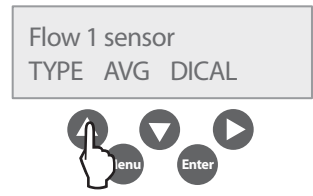

14. Press ▲ or ▼ until "Pulse -DI" appears, then press ENTER. The PT3002 saves the setting and brings you back to the screen below

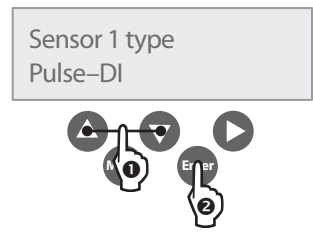

15. Press ► to Set DICAL.

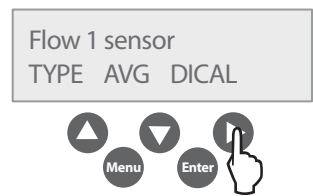

Step 1 cont.

16. Press ▲ to Set SENSOR K FACTOR.

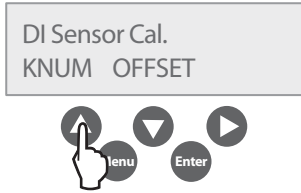

17. Use the ▲▼▶ keys to enter the K FACTOR then press ENTER (the PT3002 saves the setting and returns to the Sensor Calibration Screen)

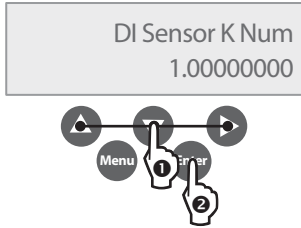

Note: See instructions pages 26 - 29 for Rain Bird Flow Sensor K & Offset information or instruction sheet included with Rain Bird Flow Sensors.

18. Press ▼ to Set SENSOR OFFSET.

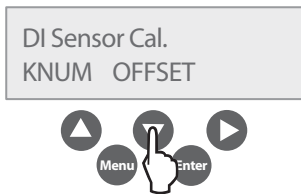

19. Use the ▲▼▶ keys to enter the OFFSET then press ENTER (the PT3002 saves the setting and returns to the Sensor Calibration Screen)

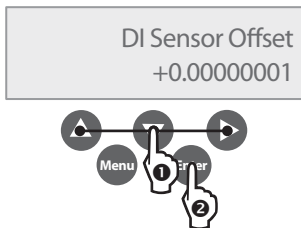

Note: See instructions pages 26 - 29 for Rain Bird Flow Sensor K & Offset information or instruction sheet included with Rain Bird Flow Sensors.

20. Press MENU until you arrive at the GPM / Total Screen.

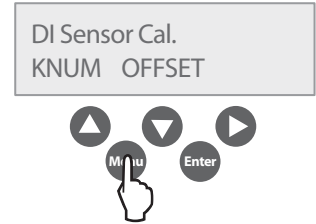

21. The screen will look as to the right.

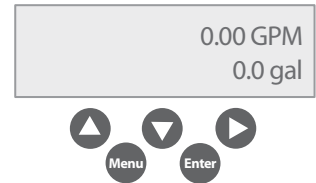

Follow Step 2a or Step 2b to complete setup.

Step 2a

Set Up as a High Flow Shut Off Device With a Stand Alone Controller

Be Sure Unit is Set Up Through Step 1 Above Before Continuing

1. Press MENU to enter Programming Mode. Press ▼ to go to the Password Screen.

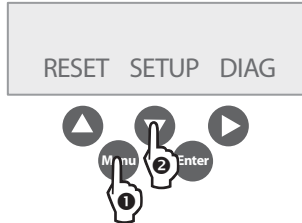

2. Use the arrow keys to enter a 4 digit password then press ENTER OR press ENTER to bypass using a password.

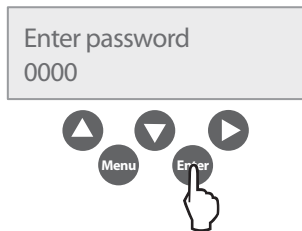

3. At the Setup screen, press ENTER.

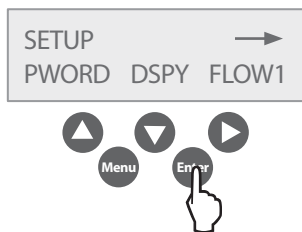

4. Press ▲ for RLY1.

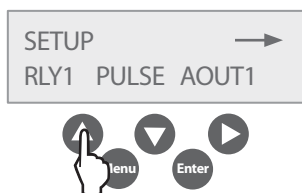

5. Press ▲ for FUNC.

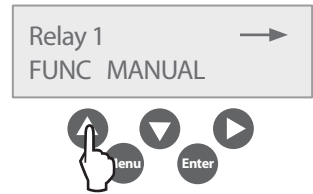

6. Press ▲ for MANUAL.

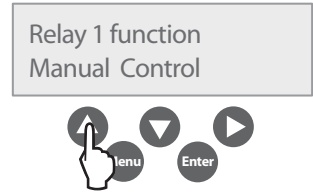

7. Press ▲ or ▼ until ALARM appears. Press ENTER to SAVE.

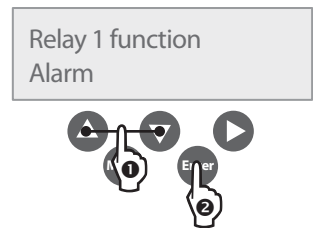

8. Press ENTER.

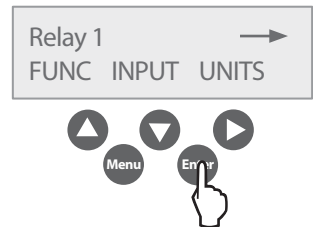

9. Press ▲.

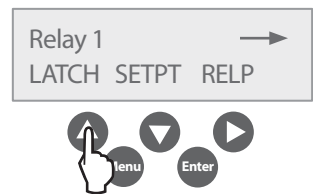

Step 2a cont.

10. Press ▲ or ▼ until brackets are around "ON" then press ENTER.

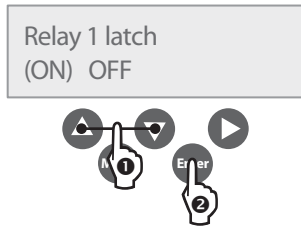

11. Press ▼ for SET POINT.

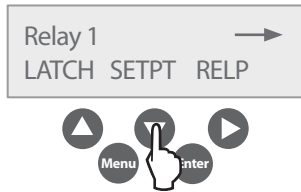

12. Use the ▲▼▶ keys to set the Flow Threshold Amount. (This amount, once exceeded, will cause the PT3002 to break the common and close the master valve, stopping flow.) Press ENTER when done.

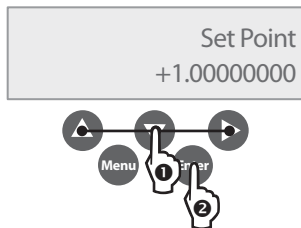

13. Press ENTER.

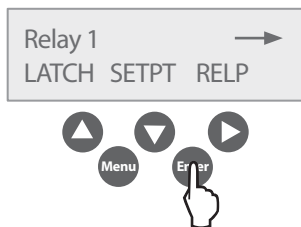

14. Press ▲.

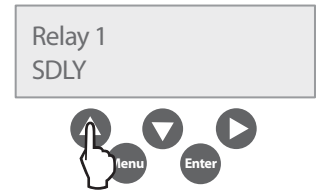

15. Use the ▲▼▶ keys to set the number of desired seconds for the PT3002 to wait before breaking the valve common and closing the Master Valve once a High Flow occurs. Press ENTER to SAVE.

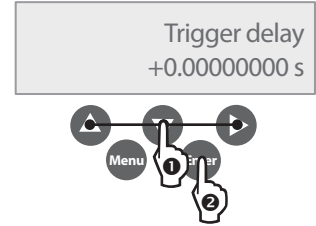

16. Press MENU until you arrive at the GPM / Total Screen.

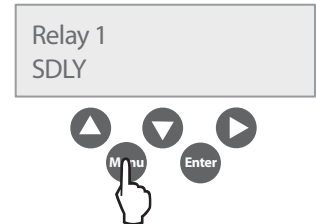

17. The screen will look as to the right.

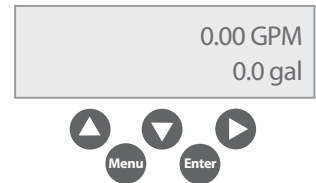

Step 2b

Set Up For Use With Central Control

Be Sure Unit is Set Up Through Step 1 Above Before Continuing

1. Press MENU to enter Programming Mode. Press ▼ to go to the Password Screen.

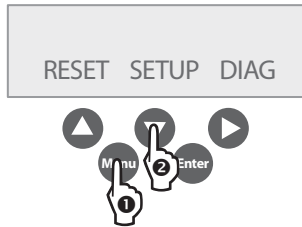

2. Use the arrow keys to enter a 4 digit password then press ENTER OR press ENTER to bypass using a password.

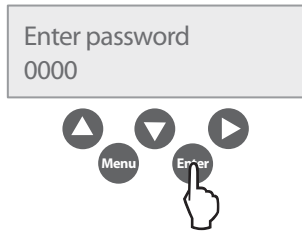

3. At the Setup screen, press ENTER.

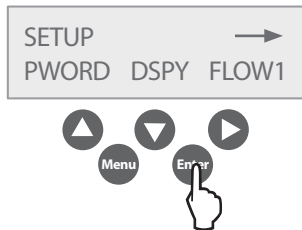

4. Press ▲ for RLY1.

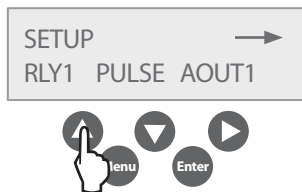

5. Press ▲ for FUNC.

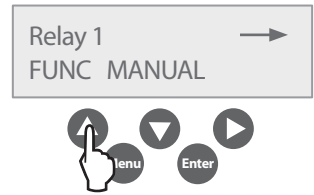

6. Press ▲ or ▼ until "TOTALIZER" is displayed and then press ENTER.

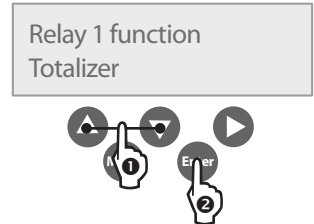

7. Press ► to set PULSE RATE UNITS.

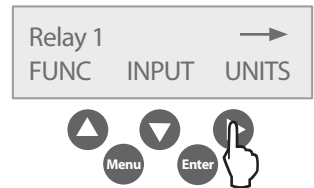

8. Press ▲ or ▼ until "gal" is displayed. Press ENTER to SAVE, then press ENTER again.

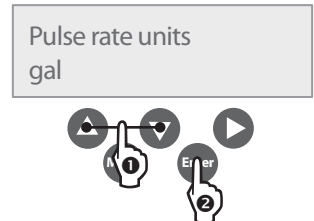

9. Press ▲ to SET RATE.

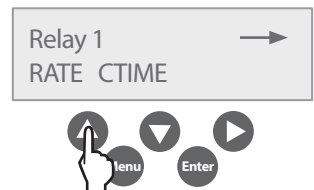

Step 2b cont.

10. Use the ▲ ▼ ► keys to SET PULSE. (Note: this will normally be set to +1.00000000). Press ENTER to SAVE.

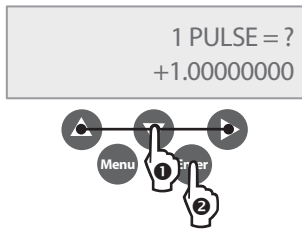

11. Press ▼ to SET CLOSETIME.

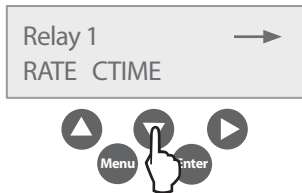

12. Use the ▲ ▼ ► keys to SET CLOSETIME. (Note: this will normally be set 100 ms). Press ENTER to SAVE.

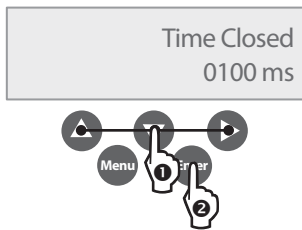

13. Press MENU three (3) times to return to Flow Total Screen.

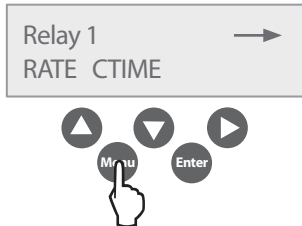

14. The screen will look as to the right.

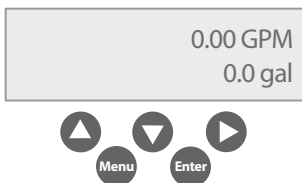

Resetting the 3002 After a High Flow Occurrence

1. Press MENU to enter Programming Mode. Press ▲ to go to the Reset Screen.

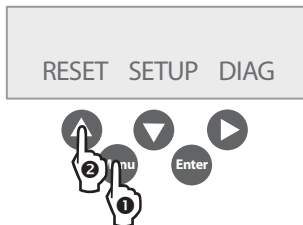

2. Press ▼ to Reset Relay.

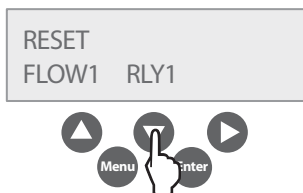

3. Press ▲ (OK) to Reset.

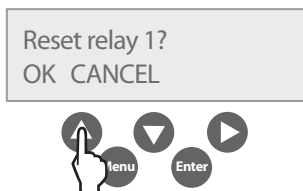

4. Press MENU twice to return to the GPM / Total Screen.

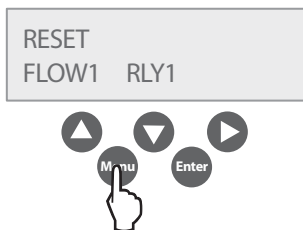

Resetting the 3002 To Zero Total Flow Readings

1. Press MENU to enter Programming Mode. Press ▲ to go to the Reset Screen.

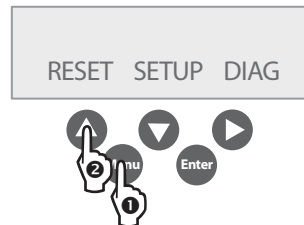

2. Press ▲ to Reset Flow.

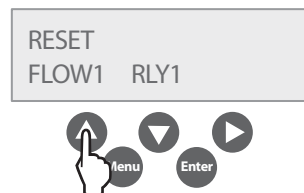

3. Press ▲ (OK) to Reset.

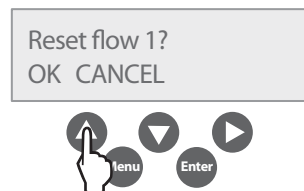

4. Press MENU twice to return to the GPM / Total Screen.

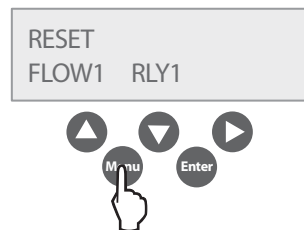

ENG

page 2

ESP

ESP

Contenidos

Instrucciones de cableado	3
For Use As A High Flow Shut Off Device With A Stand Alone Controller.....	4
Using a Normally Closed Master Valve	4
Using a Normally Open Master Valve	4
For Output to Maxicom®	5
Initial Powerup	6
Display and Key Pad	6
General Programming	6
Step 1	6
Step 2a	9
Step 2b	11
Resetting the 3002 After a High Flow Occurrence	13
Resetting the 3002 To Zero Total Flow Readings	13
Appendix A	
Appendix B	

Instrucciones de cableado

NOTA: Consulte el instructivo del monitor de flujo PT3002 y NEMACAB para instrucciones más detalladas.

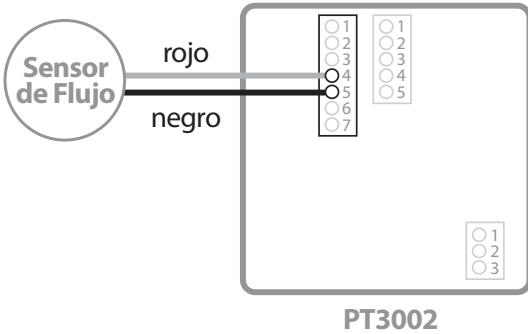

Conecte el cable rojo del sensor de flujo a la terminal cuatro del bloque de siete terminales. Conecte el cable negro del sensor de flujo a la terminal cinco del bloque de siete terminales. Vea la etiqueta del diagrama de cableado en el costado del PT3002

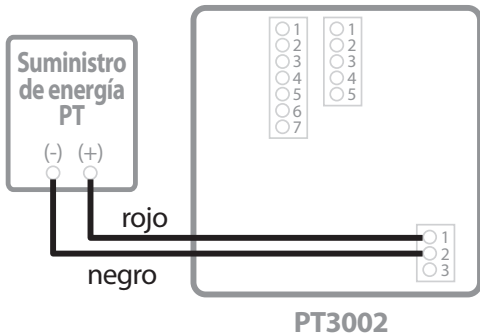

Conecte el cable rojo(+) del suministro eléctrico PT a la terminal uno del bloque de terminales de tres puertos. Conecte el cable negro / blanco (-) a la terminal dos del bloque de terminales de tres puertos.

Instrucciones de cableado (cont.)

Para usar como un dispositivo de apagado de alto flujo con un controlador independiente

Usando una válvula maestra normalmente cerrada

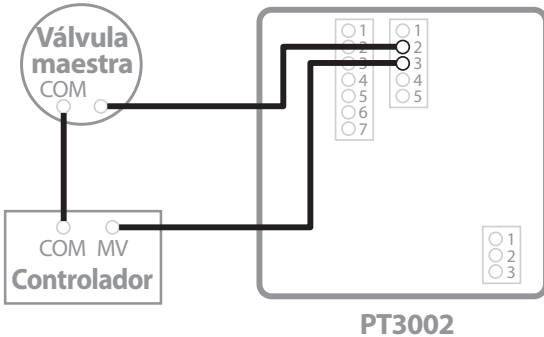

Conecte uno de los cables del solenoide de la válvula a la terminal del Relé 1 2NC. Conecte el cable de la terminal del Relé 1 COM 3 a la terminal de la válvula maestra en el controlador.

Nota: Conecte el cable común de la válvula maestra al controlador como en cualquier instalación normal.

Usando una válvula maestra normalmente abierta

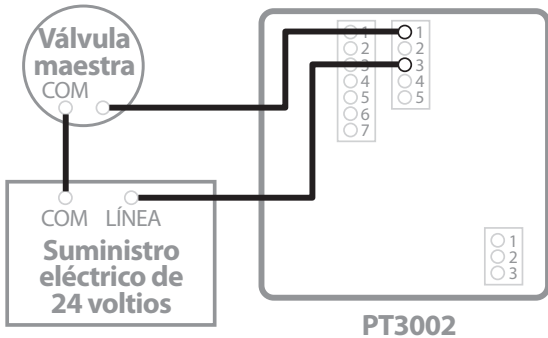

Conecte uno de los cables del solenoide de la válvula maestra a la terminal del relé 1 NO 1. Conecte el segundo cable del solenoide de la válvula a una fuente auxiliar de energía de 24 voltios. Conecte el cable del Relé 1 COM 3 al otro cable de la fuente auxiliar de energía. Cuando ocurre una condición de alto flujo el relé interno se cierra, activando la válvula maestra que está normalmente abierta y cerrándola.

Para salida hacia Maxicom® o Site Control

(complete el paso **1** de las páginas 6 a la 8 y el paso **2b** en las páginas 11 a la 12)

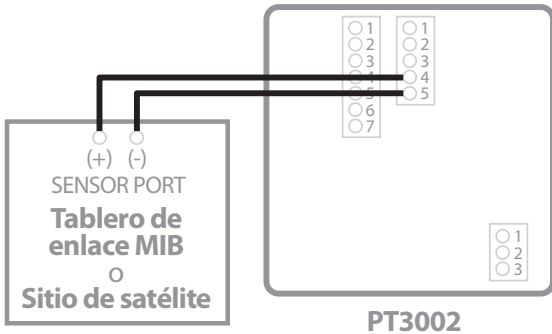

Conecte el cable desde la salida de la terminal 4 del pulso 1 a la terminal (+) del sensor de puerto en un tablero de enlace MIB ó a un sitio de satélite. Conecte el cable desde la salida de la terminal 5 del pulso 2 a la terminal negativa (-) del sensor de puerto en un tablero de enlace MIB ó a un sitio de satélite.

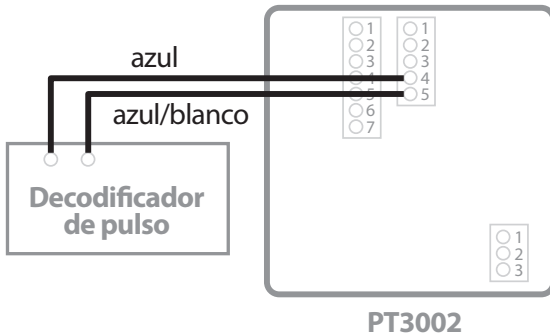

Conecte el cable desde la salida de la terminal 4 del pulso 1 al cable azul de un decodificador de pulso si se están usando dos cables de comunicación entre un CCU y un controlador de satélite. Conecte el cable desde la salida de la terminal 5 del pulso 2 al cable azul/blanco de un decodificador de pulso.

Encendido inicial



Conecte el suministro eléctrico del monitor de flujo PT3002 a una salida de corriente de 120 VAC.

Cuando el PT3002 es inicialmente encendido, se realiza una auto verificación interna, mientras en la pantalla aparece "PT3002 DIC Initializing." Al final de este ciclo la pantalla vuelve a su estado normal.

Pantalla y teclado

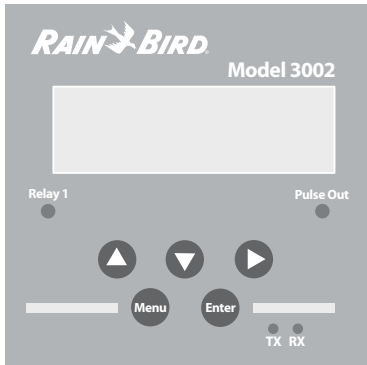

Menu

- 1- Cambie al menú principal
- 2- Atrás/ Menú previo

Enter

- 1-Salvar valor
- 2-Adelante/Siguiente menú

▲

- 1-Seleccione opción de menú
- 2-Incremente el valor numérico

▼

- 1-Seleccione opción de menú
- 2-Disminuya el valor numérico

▶

- 1-Seleccione opción de menú
- 2-Mueva el cursor a la derecha

Programación general

Paso 1

1. Presione MENU para ingresar a la modalidad de programación. Presione ▼ para ir a la pantalla de contraseña.

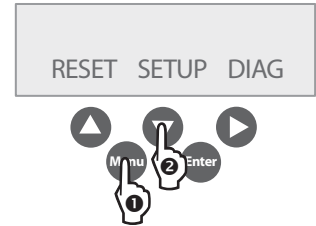

2. Utilice las teclas de flecha para ingresar una contraseña de 4 dígitos y después presione ENTER ó presione ENTER para no usar la contraseña.

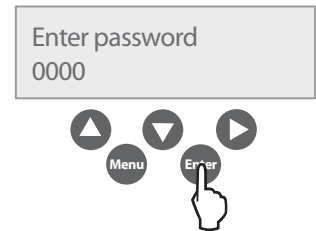

3. En el menú de configuración presione ▶ para ir a la pantalla de configuración del flujo1 (Flow 1)

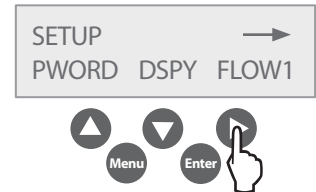

4. Presione ▲ para ir a la pantalla de rango de flujo 1 (Flow 1).

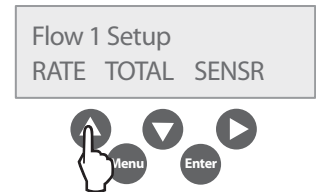

5. Presione ▲ para fijar unidades (UNITS).

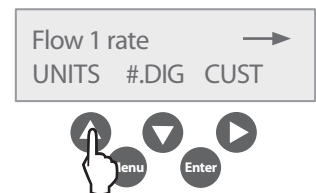

6. Fije las unidades (UNITS) para GPM* usando ▲ ó ▼ y después presione ENTER (el PT3002 salva la configuración).
(Nota: GPM se usa como un ejemplo en todo el manual.)

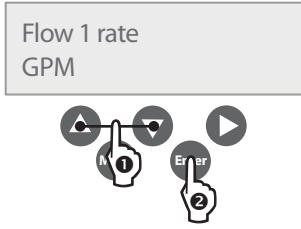

7. Presione MENU una vez para ir a la pantalla de configuración de flujo 1.

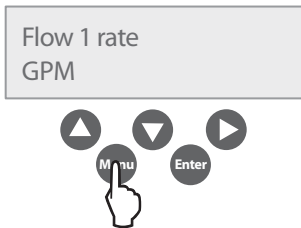

8. Presione ▼ para fijar el TOTAL.

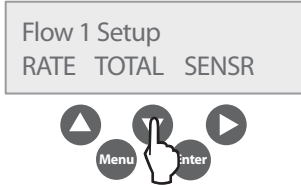

9. Presione ▲ para fijar UNITS.

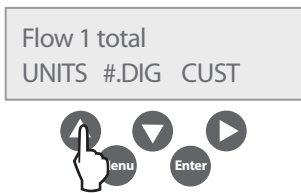

10. Fijar UNITS para gal usando ▲ ó ▼ y después presione ENTER (el PT3002 guarda la configuración)

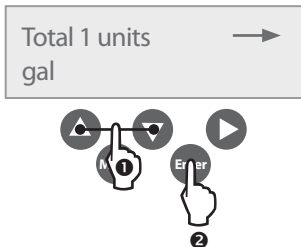

11. Presione MENU dos veces para ir a la pantalla de configuración de flujo 1.

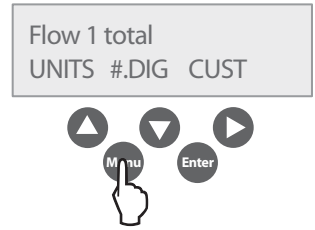

12. Presione ► para fijar SENSOR.

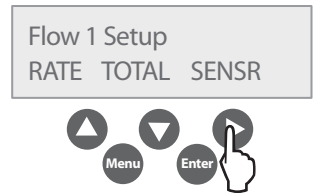

13. Presione ▲ para fijar TYPE.

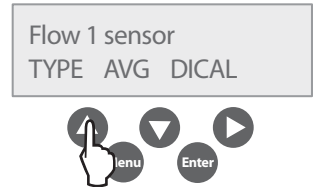

14. Presione ▲ ó ▼ hasta que "Pulse -DI" aparece, después, presione ENTER. El PT3002 guarda la configuración y regresa a la pantalla de abajo.

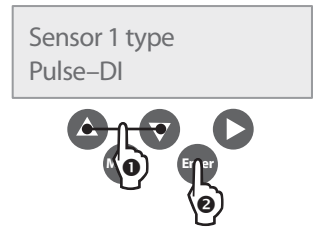

15. Presione ► para fijar DICAL.

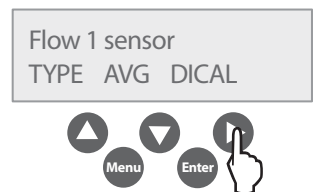

Paso 1 cont.

16. Presione ▲ para fijar el FACTOR K del SENSOR.

DI Sensor Cal.
KNUM OFFSET



17. Utilice las teclas ▲ ▼ ► para ingresar el FACTOR K y después presione ENTER (el PT32002 guarda la configuración y regresa a la pantalla de calibración del sensor)

DI Sensor K Num
1.00000000

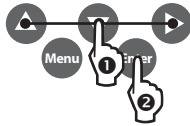

Nota: Vea las instrucciones en las paginas 26 - 29 para información sobre el sensor K de flujo marca Rain Bird y la hoja de instrucciones ó información impresa incluida con los sensores de flujo Rain Bird.

18. Presione ▼ para fijar SENSOR OFFSET.

DI Sensor Cal.
KNUM OFFSET



19. Utilice las teclas ▲ ▼ ► para ingresar el OFFSET y después presione ENTER (el PT32002 guarda la configuración y regresa a la pantalla de calibración del sensor)

DI Sensor Offset
+0.00000001

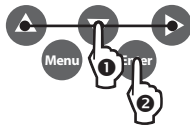

Nota: Vea las instrucciones en las paginas 26 - 29 para información sobre el sensor K de flujo marca Rain Bird y la hoja de instrucciones ó información impresa incluida con los sensores de flujo Rain Bird.

20. Presione MENU hasta llegar a la pantalla GPM / Total.

DI Sensor Cal.
KNUM OFFSET



21. La pantalla se verá como a la derecha.

0.00 GPM
0.0 gal



Siga los pasos 2a ó 2b para completar la configuración.

Step 2a

Configurar como un dispositivo de apagado de alto flujo con un controlador independiente.

Asegúrese que la unidad ha sido configurada hasta el paso 1 de arriba antes de continuar.

1. Presione MENU para ingresar a la modalidad de programación. Presione ▼ para ir a la pantalla de contraseña.

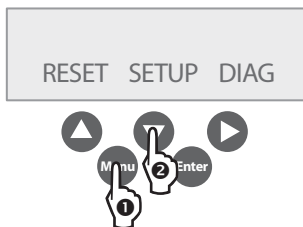

2. Utilice las teclas de flecha para ingresar una contraseña de 4 dígitos y después presione ENTER ó presione ENTER para no usar la contraseña.

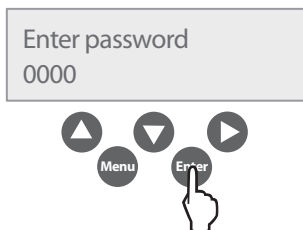

3. En la pantalla de configuración, presione ENTER.

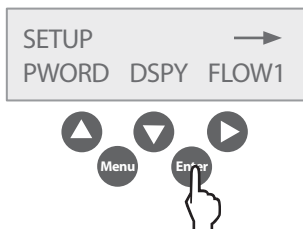

4. Presione ▲ para RLY1.

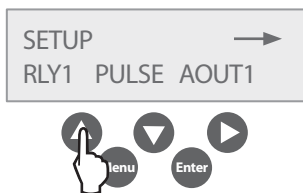

5. Presione ▲ para FUNC.

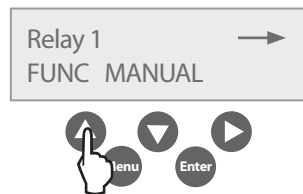

6. Presione ▲ para MANUAL.

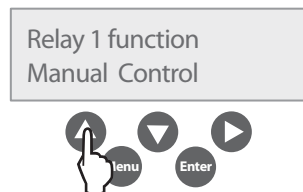

7. Presione ▲ ó ▼ hasta que aparezca ALARM. Presione ENTER para salvar.

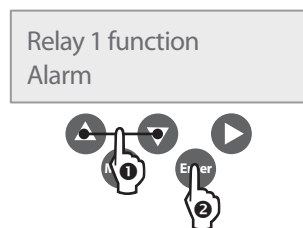

8. Presione ENTER.

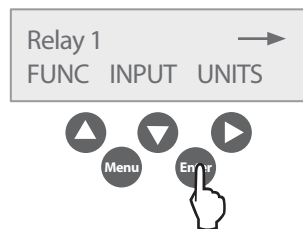

9. Presione ▲.

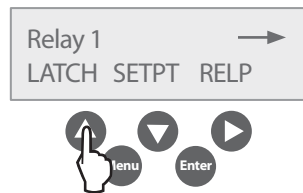

Paso 2a cont.

10. Presione ▲ ó

▼ hasta que los paréntesis aparezcan alrededor del "ON" y después presione ENTER.

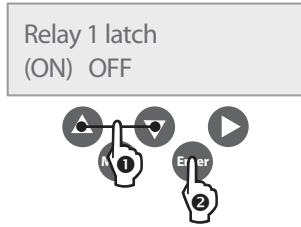

11. Presione ▼ para SET POINT.

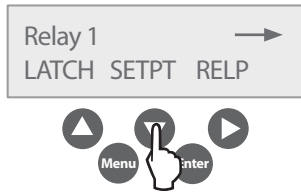

12. Utilice las teclas ▲▼▶ para fijar la cantidad de flujo límite. (Una vez excedida esta cantidad, el PT3002 causará una interrupción en el común cerrando la válvula maestra, deteniendo el flujo.) Presione ENTER al concluir.

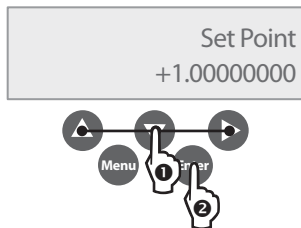

13. Presione ENTER.

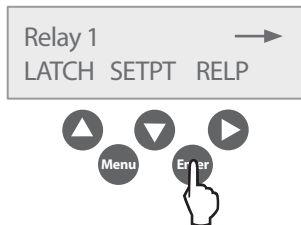

14. Presione ▲.

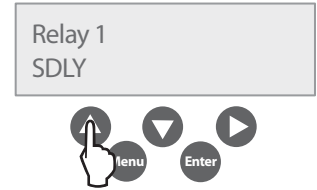

15. Utilice las teclas ▲▼▶ para fijar el número de segundos deseados que el PT3002 deberá esperar antes de interrumpir el común de la válvula y cerrar la válvula maestra una vez que ocurre un alto flujo. Presione ENTER para salvar.

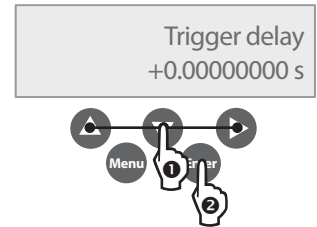

16. Presione MENU hasta llegar a la pantalla GPM / Total.

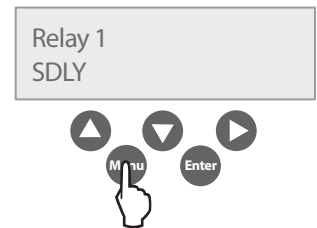

17. La pantalla se verá como a la derecha.

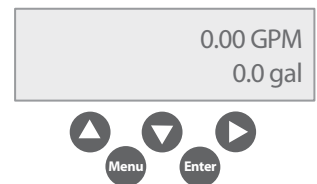

Paso 2b

Configuración para usar con control centralizado

Asegúrese que Unit ha sido configurado por medio del paso 1 de arriba antes de continuar

1. Presione MENU para ingresar el modo de programación. Presione ▼ para ir a la pantalla de contraseña.

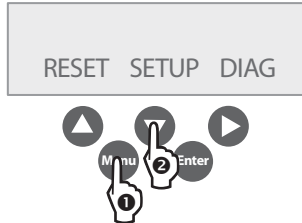

2. Utilice las teclas de flecha para ingresar una contraseña de 4 dígitos y después presione ENTER ó presione ENTER para no usar la contraseña.

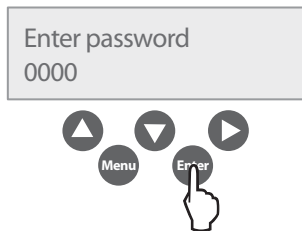

3. Presione ENTER en la pantalla de configuración.

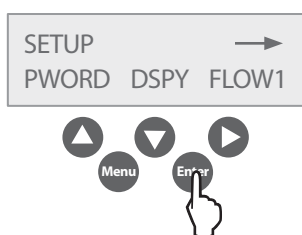

4. Presione ▲ para RLY1.

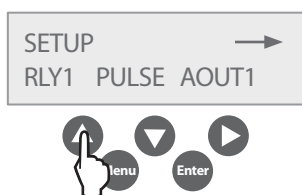

5. Presione ▲ para FUNC.

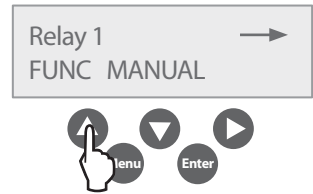

6. Presiones ▲ ó ▼ hasta que aparezca "TOTALIZER" en la pantalla y después presione ENTER.

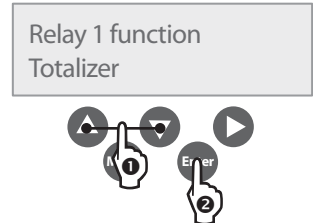

7. Presione ► para configurar PULSE RATE UNITS (unidades de rango de pulso).

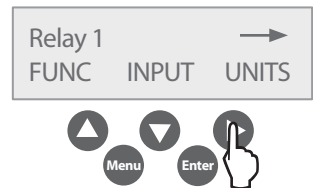

8. Presione ▲ ó ▼ hasta que "gal" aparezca en la pantalla. Presione ENTER para salvar, y después presione ENTER de nuevo.

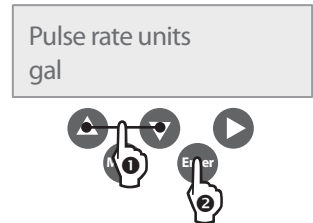

9. Presione ▲ para fijar el rango (SET RATE).

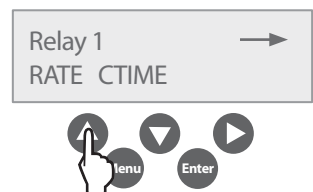

Paso 2b cont.

10. Utilice los teclados ▲▼▶ para fijar SET PULSE.
(Nota: Esto será normalmente fijado a +1.00000000). Presione ENTER para salvar.

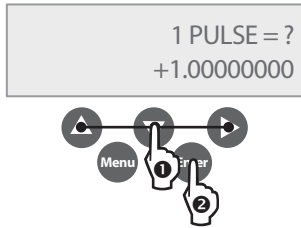

11. Presione ▼ para fijar CLOSETIME.

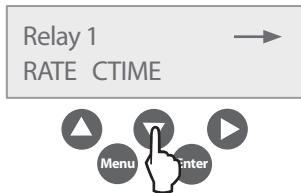

12. Utilice los teclados de ▲▼▶ para fijar CLOSETIME.
(Nota: estará normalmente fijado a 100ms). Presione ENTER para salvar.

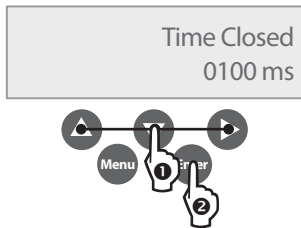

13. Presione MENU tres (3) veces para regresar a la pantalla Flow Total.

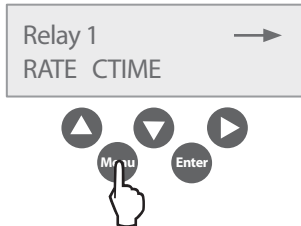

14. La pantalla se verá como a la derecha.

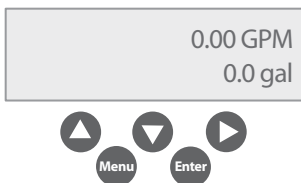

Reconfigurar el 3002 después de presentarse un alto flujo

1. Presione MENU para ingresar el modo de programación. Presione ▲ para ir a la pantalla de reconfiguración.

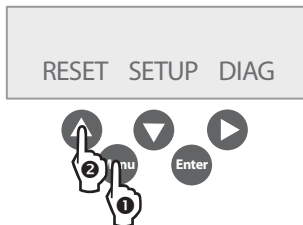

2. Presione ▼ para reconfigurar el Relé.

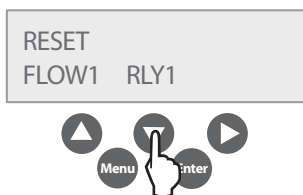

3. Presione ▲ (OK) para reconfigurar.



4. Presione MENU dos veces para regresar a la pantalla GPM / Total.

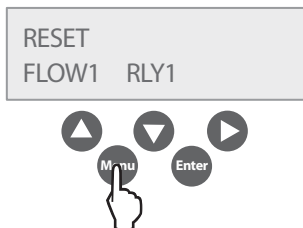

Reconfigurar el 3002 a una lectura total de cero flujo

1. Presione MENU para ingresar el modo de programación. Presione ▲ para ir a la pantalla de reconfiguración.

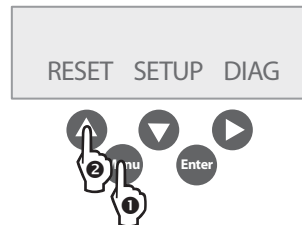

2. Presione ▲ para reconfigurar el flujo (Flow).

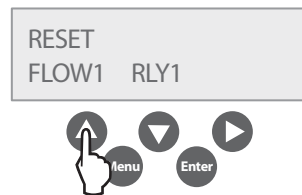

3. Presionar ▲ (OK) para reconfigurar.

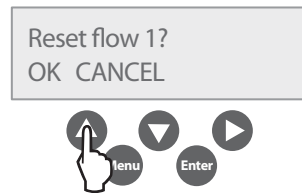

4. Presione MENU dos veces para regresar a la pantalla GPM / Total.

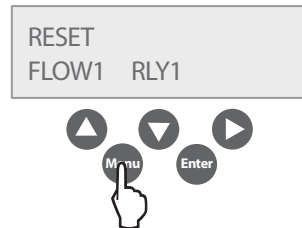

Appendix A *Apéndice A*

For Tee Type Flow Sensors Rain Bird Models FS100B, FS150P, FS200P, FS300P or FS400P use the K & Offset chart below.

Para sensores tipo Te de modelos Rain Bird FS100B, FS150P, FS200P, FS300P o FS400P utilice la tabla K & valores de la parte inferior.

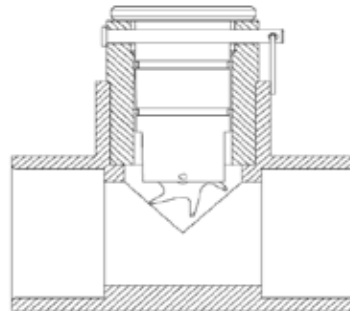

Calibration Table for Tee Mounted Sensors
Tabla de calibración para sensores de montaje en Te

Model	Size	K Value	Offset	Suggested Operating Range (GPM)
FS100B	1"	0.41447	0.41447	2-40
FS100B	1½"	1.848	0.227	3-100
FS100B	2"	2.725	.392	5-200
FS100B	3"	8.309	0.227	12-300
FS100B	4"	15.35	0.248	25-500

Appendix B Apéndice B

For Insert Type Flow Sensors Rain Bird Models FS350B or FS350SS

Para sensores Rain Bird tipo inserto de modelos FS350B ó FS350SS

Calibration Table for Pipe Sizes 3" through 36"

Tabla de calibración para tuberías de 3" a 36"

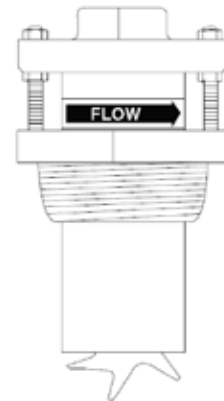

Pipe Size	Pipe O.D.	Pipe I.D.	K Value	Offset	Suggested Operating Range (GPM)
Pipe Size 3" Sch 10S	3.500"	3.260"	5.009	0.090	12-400
Std. Wt., Sch 40	3.5"	3.068"	4.362	0.063	12-400
Extra Strong, Sch 80	3.5"	2.900"	3.858	0.043	12-400
PVC Class 125	3.5"	3.284"	5.094	0.093	12-400
PVC Class 160	3.5"	3.230"	4.902	0.085	12-400
PVC Class 200	3.5"	3.166"	4.682	0.076	12-400
4" Sch 10S	4.5"	4.260"	9.597	0.241	20-600
Std. Wt., Sch 40	4.5"	4.026"	8.34	0.229	20-600
Extra Strong, Sch 80	4.5"	3.826"	7.354	0.188	20-600
PVC Class 125	4.5"	4.224"	9.396	0.240	20-600
PVC Class 160	4.5"	4.154"	9.013	0.240	20-600
PVC Class 200	4.5"	4.072"	8.578	0.239	20-600
5" Sch 10S	5.563"	5.295"	16.305	0.250	30-900
Std. Wt., Sch 40	5.50"	5.047"	14.674	0.248	30-900
Extra Strong, Sch 80	5.50"	4.813"	13.165	0.246	30-900
6" Sch 10S	6.625"	6.357"	24.089	0.260	50-1,500
Std. Wt., Sch 40	6.5"	6.065"	21.574	0.257	50-1,500
Extra Strong, Sch 80 PVC Class 125	6.5"	5.761"	19.457	0.254	50-1,500
Extra Strong, Sch 80 PVC Class 125	6.625"	6.217"	22.853	0.258	50-1,500
PVC Class 160	6.625"	6.115"	21.968	0.257	50-1,500
PVC Class 200	6.625"	5.993"	21.068	0.256	50-1,500
8" Sch 10S	8.625"	8.329"	43.914	0.286	80-2,500
Sch 20	8.625"	8.125"	41.653	0.283	80-2,500
Sch 30	8.625"	8.071"	41.063	0.283	80-2,500
Std. Wt., Sch 40	8.625"	7.981"	40.086	0.281	80-2,500
Sch 60	8.625"	7.813"	38.288	0.279	80-2,500
Extra Strong, Sch 80	8.625"	7.625"	36.315	0.276	80-2,500
PVC Class 125	8.625"	8.095"	41.324	0.283	80-2,500
PVC Class 160	8.625"	7.961"	39.869	0.281	80-2,500
PVC Class 200	8.625"	7.805"	38.203	0.279	80-2,500
10" Sch 10S	10.75"	10.420"	70.195	0.321	125-4,000
Sch 20	10.75"	10.250"	67.668	0.318	125-4,000
Sch 30	10.75"	10.136"	66.069	0.316	125-4,000
Sch 40, Std.Wt.	10.75"	10.020"	64.532	0.314	125-4,000
Extra Strong, Sch 60	10.75"	9.750"	61.016	0.309	125-4,000
Sch 80	10.75"	9.564"	58.644	0.306	125-4,000
PVC Class 125	10.75"	10.088"	65.431	0.315	125-4,000
PVC Class 160	10.75"	9.924"	63.272	0.312	125-4,000
PVC Class 200	10.75"	9.728"	60.733	0.309	125-4,000

Appendix B (cont.) Apéndice B (cont.)

Calibration Table for Pipe Sizes 3" through 36" (cont.)
Tabla de calibración para tuberías de 3" a 36" (cont.)

Pipe Size	Pipe O.D.	Pipe I.D.	K Value	Offset	Suggested Operating Range (GPM)
12" Sch 10S	12.75"	12.390"	104.636	0.367	175-5,000
Sch 20	12.75"	12.250"	102.553	0.364	175-5,000
Sch 30	12.75"	12.090"	99.347	0.360	175-5,000
Std. Wt., Sch 40S	12.75"	12.000"	97.576	0.358	175-5,000
Sch 40	12.75"	11.938"	96.369	0.356	175-5,000
Sch 60	12.75"	11.625"	90.441	0.348	175-5,000
Extra Strong	12.75"	11.750"	92.775	0.351	175-5,000
Sch 80	12.74"	11.376"	85.922	0.342	175-5,000
PVC Class 125	12.75"	11.966"	96.912	0.357	175-5,000
PVC Class 160	12.75"	11.770"	93.152	0.352	175-5,000
PVC Class 200	12.75"	11.538"	88.842	0.346	175-5,000
14" Sch 10S	14.00"	13.500"	122.307	0.391	200-6,000
Sch20	14.00"	13.375"	120.216	0.388	200-6,000
Std. Wt., Sch 30	14.00"	13.250"	118.151	0.385	200-6,000
Sch 40	14.00"	13.124"	116.096	0.382	200-6,000
Sch 60	14.00"	12.814"	111.148	0.376	200-6,000
Extra Strong	14.00"	13.00"	114.098	0.330	200-6,000
Sch 80	14.00"	12.50"	106.299	0.369	200-6,000
16" Sch 10S	16.00"	15.500"	159.243	0.440	300-9,000
Sch 20	16.00"	15.375"	156.742	0.436	300-9,000
Std. Wt., Sch 30	16.00"	15.250"	154.267	0.433	300-9,000
Sch 60	16.00"	14.688"	143.456	0.419	300-9,000
Extra Strong, Sch 40	16.00"	15.000"	149.394	0.427	300-9,000
Sch 80	16.00"	14.314"	136.548	0.410	300-9,000
18" Sch 10S	18.00"	17.500"	202.739	0.498	350-10,000
Sch 20	18.00"	17.375"	199.828	0.494	350-10,000
Sch 30	18.00"	17.124"	194.061	0.486	350-10,000
Std. Wt.	18.00"	17.250"	196.943	0.490	350-10,000
Sch 40	18.00"	16.876"	188.464	0.479	350-10,000
Sch 60	18.00"	16.500"	180.171	0.469	350-10,000
Extra Strong	18.00"	17.000"	191.250	0.482	350-10,000
Sch 80	18.00"	16.126"	172.152	0.457	350-10,000
20" Std. Wt., Sch 20	20.00"	19.25"	246.179	0.555	400-12,000
Sch 40	20.00"	18.812"	234.836	0.540	400-12,000
Extra Strong, Sch 30	20.00"	19.000"	239.666	0.547	400-12,000
Sch 80	20.00"	17.938"	213.140	0.511	400-12,000
22" Std. Wt., Sch 20	22.00"	21.25"	301.975	0.621	500-15,000
Extra Strong, Sch 30	22.00"	21.00"	294.642	0.616	500-15,000
Sch 80	22.00"	19.75"	259.513	0.573	500-15,000

Calibration Table for Pipe Sizes 3" through 36" (cont.)

Tabla de calibración para tuberías de 3" a 36" (cont.)

Pipe Size	Pipe O.D.	Pipe I.D.	K Value	Offset	Suggested Operating Range (GPM)
24" Std. Wt., Sch 20	24.00"	23.25"	364.331	0.666	600-18,000
Extra Strong	24.00"	23.00"	356.178	0.660	600-18,000
Sch 40	24.00"	22.624"	344.109	0.652	600-18,000
Sch 80	24.00"	21.562"	311.271	0.628	600-18,000
26" Sch 10	26.00"	25.376"	437.809	0.719	700-21,000
Std. Wt.	26.00"	25.25"	433.247	0.716	700-21,000
Sch 20, Extra Strong	26.00"	25.00"	424.274	0.709	700-21,000
28" Sch 10	28.00"	27.376"	513.698	0.774	900-23,000
Std. Wt.	28.00"	27.25"	508.723	0.770	900-23,000
Extra Strong, Sch 20	28.00"	27.00"	498.930	0.763	900-23,000
30" Sch 10	30.00"	29.376"	596.147	0.833	1,000-30,000
Std. Wt.	30.00"	29.25"	590.759	0.829	1,000-30,000
Sch 20, Extra Strong	30.00"	29.00"	580.146	0.822	1,000-30,000
32" Sch 10	32.00"	31.376"	685.156	0.897	1,200-35,000
Std. Wt.	32.00"	31.25"	679.355	0.893	1,200-35,000
Sch 20, Extra Strong	32.00"	31.00"	667.922	0.885	1,200-35,000
Sch 40	32.00"	30.624"	650.919	0.873	1,200-35,000
34" Sch 10	34.00"	33.312"	777.566	0.964	1,300-40,000
Std. Wt.	34.00"	33.25"	774.511	0.962	1,300-40,000
Extra Strong, Sch 20	34.00"	33.00"	762.258	0.953	1,300-40,000
Sch 40	34.00"	32.624"	744.022	0.940	1,300-40,000
36" Sch 10	36.00"	35.376"	882.855	1.040	1,500-45,000
Std. Wt.	36.00"	35.25"	876.227	1.035	1,500-45,000
Sch 20, Extra Strong	36.00"	35.00"	863.154	1.025	1,500-45,000
Sch 40	36.00"	34.50"	837.315	1.007	1,500-45,000

Step 2b

Set Up For Use With Central Control

Be Sure Unit is Set Up Through Step 1 Above Before Continuing

1. Press MENU to enter Programming Mode. Press ▼ to go to the Password Screen.

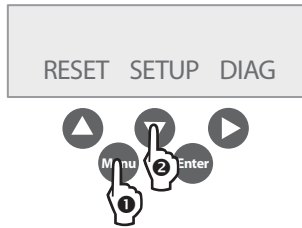

2. Use the arrow keys to enter a 4 digit password then press ENTER OR press ENTER to bypass using a password.

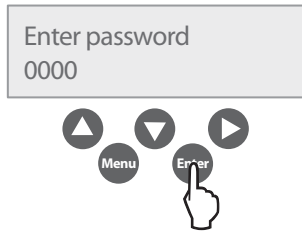

3. At the Setup screen, press ENTER.

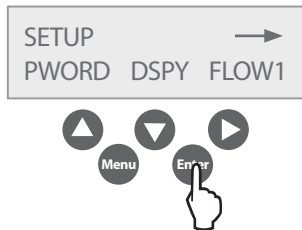

4. Press ▲ for RLY1.

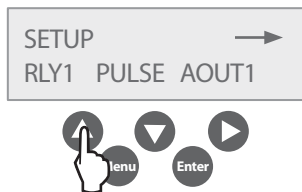

5. Press ▲ for FUNC.

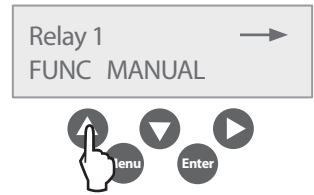

6. Press ▲ or ▼ until "TOTALIZER" is displayed and then press ENTER.

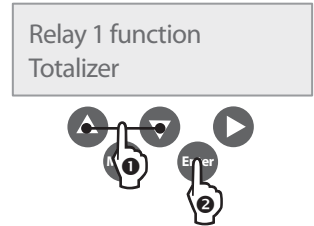

7. Press ► to set PULSE RATE UNITS.

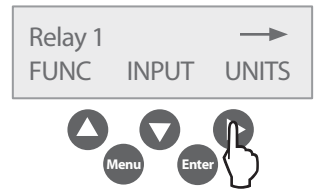

8. Press ▲ or ▼ until "gal" is displayed. Press ENTER to SAVE, then press ENTER again.

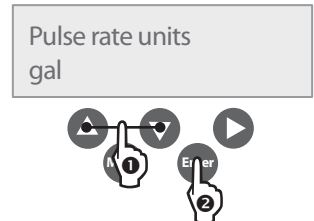

9. Press ▲ to SET RATE.

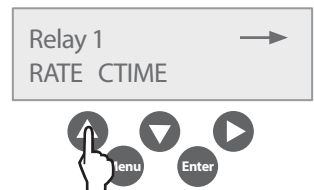

Step 2b cont.

10. Use the ▲ ▼ ► keys to SET PULSE. (Note: this will normally be set to +1.00000000). Press ENTER to SAVE.

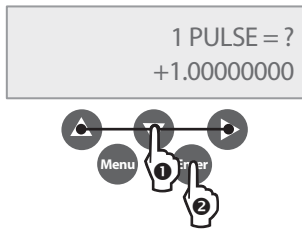

11. Press ▼ to SET CLOSETIME.

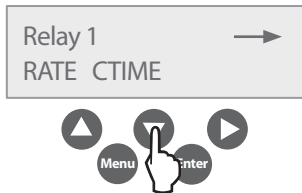

12. Use the ▲ ▼ ► keys to SET CLOSETIME. (Note: this will normally be set 100 ms). Press ENTER to SAVE.

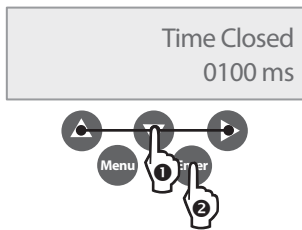

13. Press MENU three (3) times to return to Flow Total Screen.

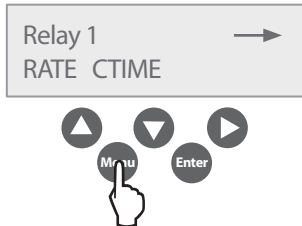

14. The screen will look as to the right.

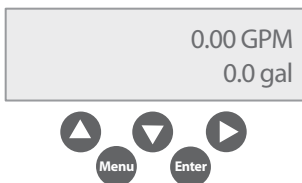

Resetting the 3002 After a High Flow Occurrence

1. Press MENU to enter Programming Mode. Press ▲ to go to the Reset Screen.

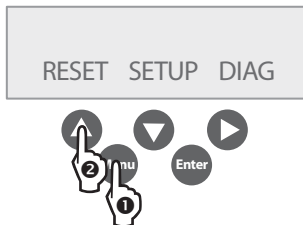

2. Press ▼ to Reset Relay.

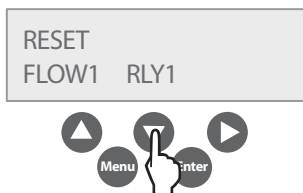

3. Press ▲ (OK) to Reset.

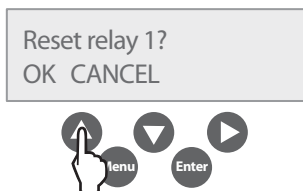

4. Press MENU twice to return to the GPM / Total Screen.

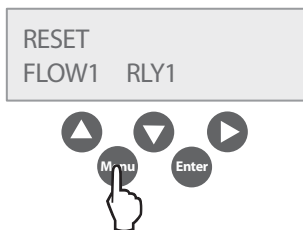

Resetting the 3002 To Zero Total Flow Readings

1. Press MENU to enter Programming Mode. Press ▲ to go to the Reset Screen.

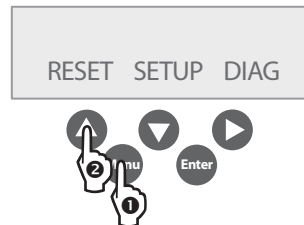

2. Press ▲ to Reset Flow.

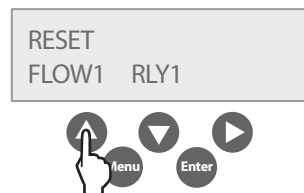

3. Press ▲ (OK) to Reset.

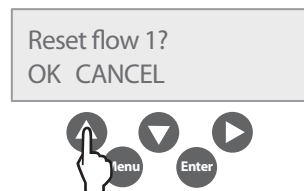

4. Press MENU twice to return to the GPM / Total Screen.

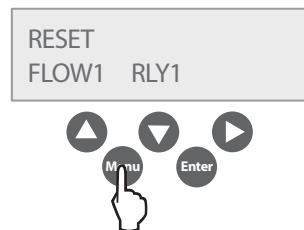

ENG

page 2

ESP

ESP

Contenidos

Instrucciones de cableado	3
For Use As A High Flow Shut Off Device With A Stand Alone Controller.....	4
Using a Normally Closed Master Valve	4
Using a Normally Open Master Valve	4
For Output to Maxicom®	5
Initial Powerup	6
Display and Key Pad	6
General Programming	6
Step 1	6
Step 2a	9
Step 2b	11
Resetting the 3002 After a High Flow Occurrence	13
Resetting the 3002 To Zero Total Flow Readings	13
Appendix A	
Appendix B	

Instrucciones de cableado

NOTA: Consulte el instructivo del monitor de flujo PT3002 y NEMACAB para instrucciones más detalladas.

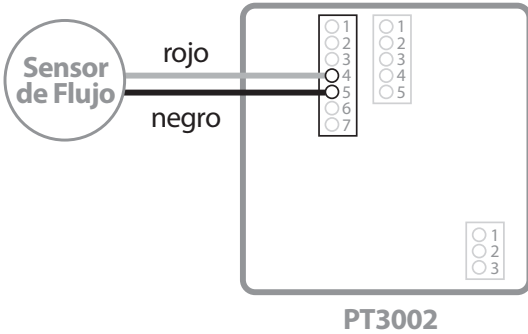

Conecte el cable rojo del sensor de flujo a la terminal cuatro del bloque de siete terminales. Conecte el cable negro del sensor de flujo a la terminal cinco del bloque de siete terminales. Vea la etiqueta del diagrama de cableado en el costado del PT3002

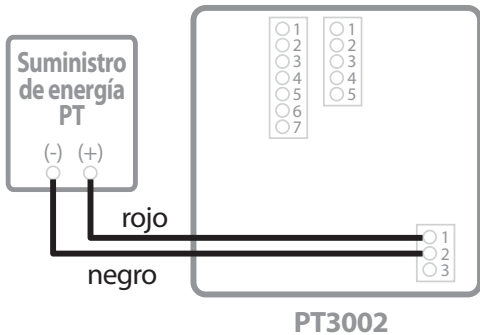

Conecte el cable rojo(+) del suministro eléctrico PT a la terminal uno del bloque de terminales de tres puertos. Conecte el cable negro / blanco (-) a la terminal dos del bloque de terminales de tres puertos.

Instrucciones de cableado (cont.)

Para usar como un dispositivo de apagado de alto flujo con un controlador independiente

Usando una válvula maestra normalmente cerrada

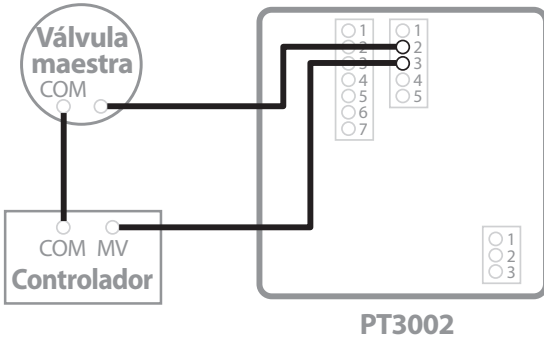

Conecte uno de los cables del solenoide de la válvula a la terminal del Relé 1 2NC. Conecte el cable de la terminal del Relé 1 COM 3 a la terminal de la válvula maestra en el controlador.

Nota: Conecte el cable común de la válvula maestra al controlador como en cualquier instalación normal.

Usando una válvula maestra normalmente abierta

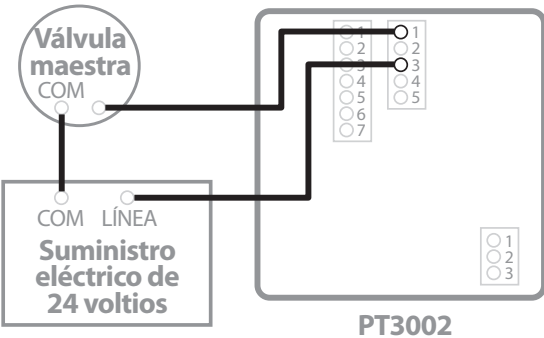

Conecte uno de los cables del solenoide de la válvula maestra a la terminal del relé 1 NO 1. Conecte el segundo cable del solenoide de la válvula a una fuente auxiliar de energía de 24 voltios. Conecte el cable del Relé 1 COM 3 al otro cable de la fuente auxiliar de energía. Cuando ocurre una condición de alto flujo el relé interno se cierra, activando la válvula maestra que está normalmente abierta y cerrándola.

Para salida hacia Maxicom® o Site Control

(complete el paso **1** de las páginas 6 a la 8 y el paso **2b** en las páginas 11 a la 12)

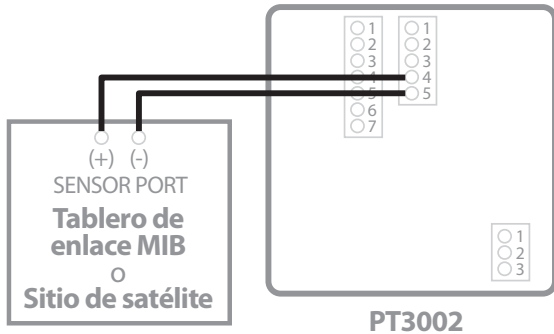

Conecte el cable desde la salida de la terminal 4 del pulso 1 a la terminal (+) del sensor de puerto en un tablero de enlace MIB ó a un sitio de satélite. Conecte el cable desde la salida de la terminal 5 del pulso 2 a la terminal negativa (-) del sensor de puerto en un tablero de enlace MIB ó a un sitio de satélite.

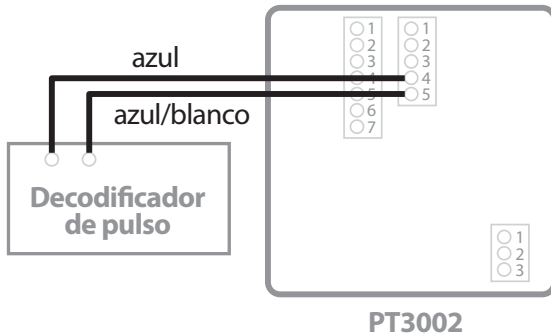

Conecte el cable desde la salida de la terminal 4 del pulso 1 al cable azul de un decodificador de pulso si se están usando dos cables de comunicación entre un CCU y un controlador de satélite. Conecte el cable desde la salida de la terminal 5 del pulso 2 al cable azul/blanco de un decodificador de pulso.

Encendido inicial



Conecte el suministro eléctrico del monitor de flujo PT3002 a una salida de corriente de 120 VAC.

Cuando el PT3002 es inicialmente encendido, se realiza una auto verificación interna, mientras en la pantalla aparece "PT3002 DIC Initializing." Al final de este ciclo la pantalla vuelve a su estado normal.

Pantalla y teclado

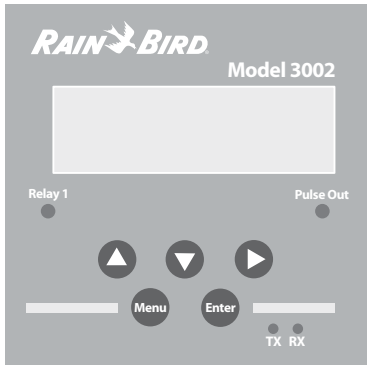

Menu

- 1- Cambie al menú principal
- 2- Atrás/ Menú previo

Enter

- 1-Salvar valor
- 2-Adelante/Siguiente menú

▲

- 1-Seleccione opción de menú
- 2-Incremente el valor numérico

▼

- 1-Seleccione opción de menú
- 2-Disminuya el valor numérico

▶

- 1-Seleccione opción de menú
- 2-Mueva el cursor a la derecha

Programación general

Paso 1

1. Presione MENU para ingresar a la modalidad de programación. Presione ▼ para ir a la pantalla de contraseña.

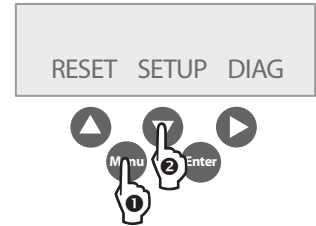

2. Utilice las teclas de flecha para ingresar una contraseña de 4 dígitos y después presione ENTER ó presione ENTER para no usar la contraseña.

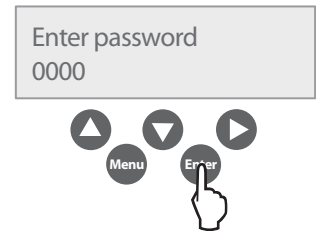

3. En el menú de configuración presione ▶ para ir a la pantalla de configuración del flujo1 (Flow 1)

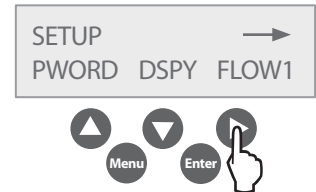

4. Presione ▲ para ir a la pantalla de rango de flujo 1 (Flow 1).

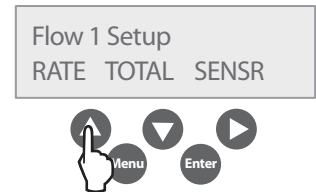

5. Presione ▲ para fijar unidades (UNITS).

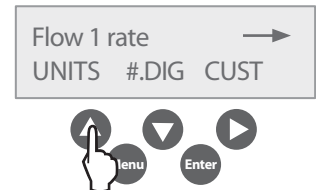

6. Fije las unidades (UNITS) para GPM* usando ▲ ó ▼ y después presione ENTER (el PT3002 salva la configuración).
(Nota: GPM se usa como un ejemplo en todo el manual.)

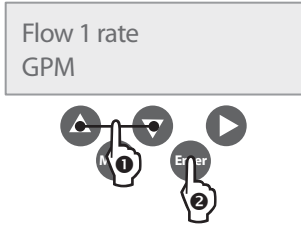

7. Presione MENU una vez para ir a la pantalla de configuración de flujo 1.

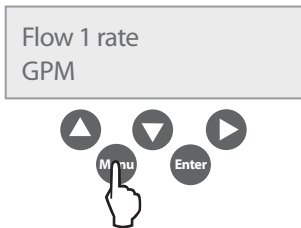

8. Presione ▼ para fijar el TOTAL.

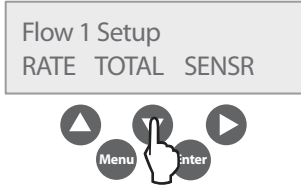

9. Presione ▲ para fijar UNITS.

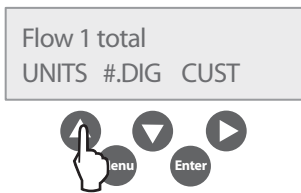

10. Fijar UNITS para gal usando ▲ ó ▼ y después presione ENTER (el PT3002 guarda la configuración)

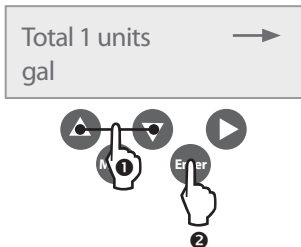

11. Presione MENU dos veces para ir a la pantalla de configuración de flujo 1.

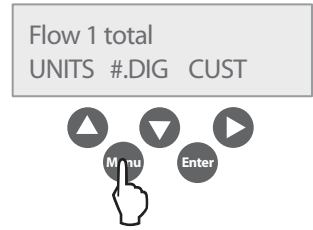

12. Presione ► para fijar SENSOR.

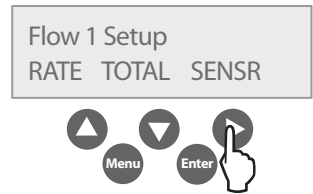

13. Presione ▲ para fijar TYPE.

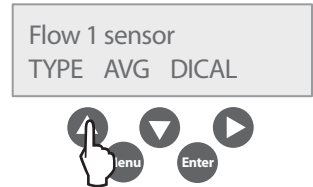

14. Presione ▲ ó ▼ hasta que "Pulse -DI" aparece, después, presione ENTER. El PT3002 guarda la configuración y regresa a la pantalla de abajo.

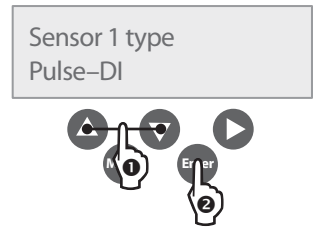

15. Presione ► para fijar DICAL.

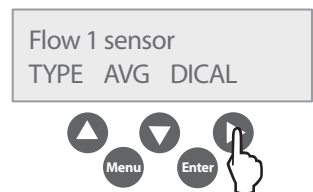

Paso 1 cont.

16. Presione ▲ para fijar el FACTOR K del SENSOR.

DI Sensor Cal.
KNUM OFFSET



17. Utilice las teclas ▲ ▼ ► para ingresar el FACTOR K y después presione ENTER (el PT32002 guarda la configuración y regresa a la pantalla de calibración del sensor)

DI Sensor K Num
1.00000000

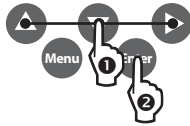

Nota: Vea las instrucciones en las paginas 26 - 29 para información sobre el sensor K de flujo marca Rain Bird y la hoja de instrucciones ó información impresa incluida con los sensores de flujo Rain Bird.

18. Presione ▼ para fijar SENSOR OFFSET.

DI Sensor Cal.
KNUM OFFSET



19. Utilice las teclas ▲ ▼ ► para ingresar el OFFSET y después presione ENTER (el PT32002 guarda la configuración y regresa a la pantalla de calibración del sensor)

DI Sensor Offset
+0.00000001

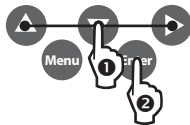

Nota: Vea las instrucciones en las paginas 26 - 29 para información sobre el sensor K de flujo marca Rain Bird y la hoja de instrucciones ó información impresa incluida con los sensores de flujo Rain Bird.

20. Presione MENU hasta llegar a la pantalla GPM / Total.

DI Sensor Cal.
KNUM OFFSET



21. La pantalla se verá como a la derecha.

0.00 GPM
0.0 gal



Siga los pasos 2a ó 2b para completar la configuración.

Step 2a

Configurar como un dispositivo de apagado de alto flujo con un controlador independiente.

Asegúrese que la unidad ha sido configurada hasta el paso 1 de arriba antes de continuar.

1. Presione MENU para ingresar a la modalidad de programación. Presione ▼ para ir a la pantalla de contraseña.

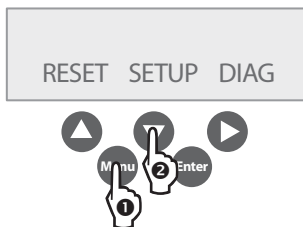

2. Utilice las teclas de flecha para ingresar una contraseña de 4 dígitos y después presione ENTER ó presione ENTER para no usar la contraseña.

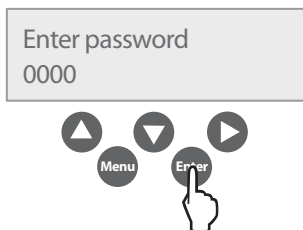

3. En la pantalla de configuración, presione ENTER.

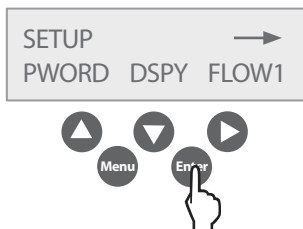

4. Presione ▲ para RLY1.

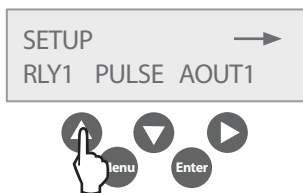

5. Presione ▲ para FUNC.

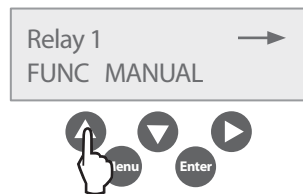

6. Presione ▲ para MANUAL.

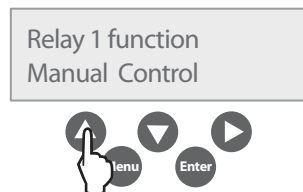

7. Presione ▲ ó ▼ hasta que aparezca ALARM. Presione ENTER para salvar.

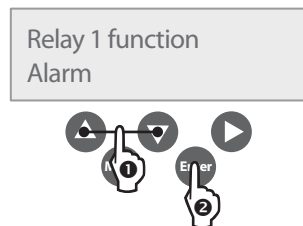

8. Presione ENTER.

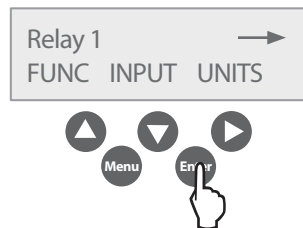

9. Presione ▲.

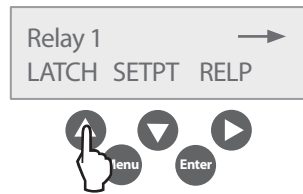

Paso 2a cont.

10. Presione ▲ ó

▼ hasta que los paréntesis aparezcan alrededor del "ON" y después presione ENTER.

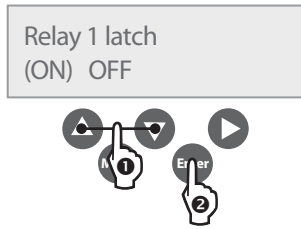

11. Presione ▼ para SET POINT.

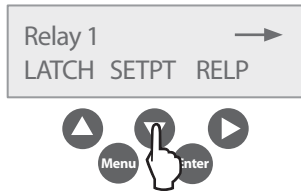

12. Utilice las teclas ▲▼▶ para fijar la cantidad de flujo límite. (Una vez excedida esta cantidad, el PT3002 causará una interrupción en el común cerrando la válvula maestra, deteniendo el flujo.) Presione ENTER al concluir.

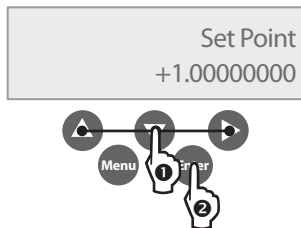

13. Presione ENTER.

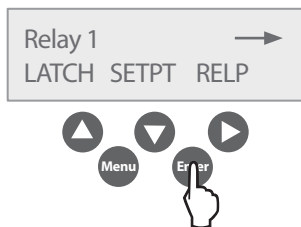

14. Presione ▲.

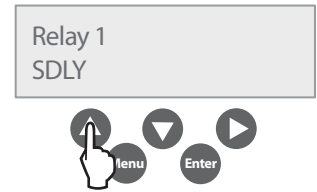

15. Utilice las teclas ▲▼▶ para fijar el número de segundos deseados que el PT3002 deberá esperar antes de interrumpir el común de la válvula y cerrar la válvula maestra una vez que ocurre un alto flujo. Presione ENTER para salvar.

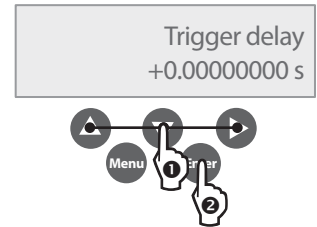

16. Presione MENU hasta llegar a la pantalla GPM / Total.

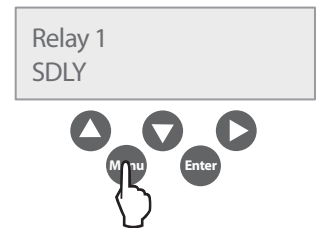

17. La pantalla se verá como a la derecha.

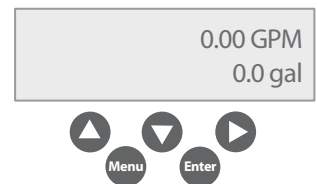

Paso 2b

Configuración para usar con control centralizado

Asegúrese que Unit ha sido configurado por medio del paso 1 de arriba antes de continuar

1. Presione MENU para ingresar el modo de programación. Presione ▼ para ir a la pantalla de contraseña.

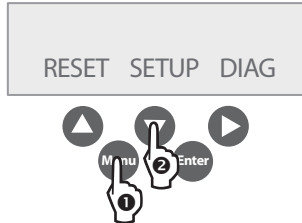

2. Utilice las teclas de flecha para ingresar una contraseña de 4 dígitos y después presione ENTER ó presione ENTER para no usar la contraseña.

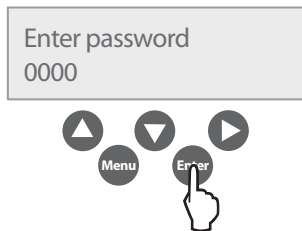

3. Presione ENTER en la pantalla de configuración.

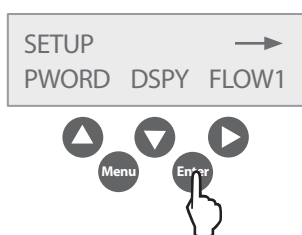

4. Presione ▲ para RLY1.

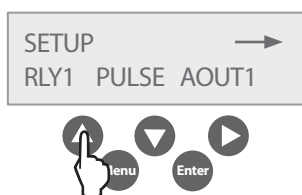

5. Presione ▲ para FUNC.

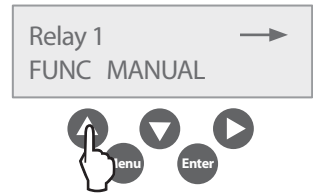

6. Presiones ▲ ó ▼ hasta que aparezca "TOTALIZER" en la pantalla y después presione ENTER.

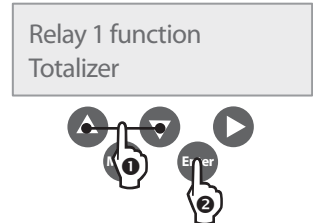

7. Presione ► para configurar PULSE RATE UNITS (unidades de rango de pulso).

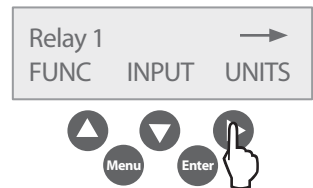

8. Presione ▲ ó ▼ hasta que "gal" aparezca en la pantalla. Presione ENTER para salvar, y después presione ENTER de nuevo.

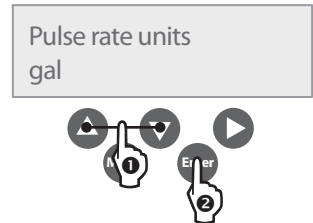

9. Presione ▲ para fijar el rango (SET RATE).

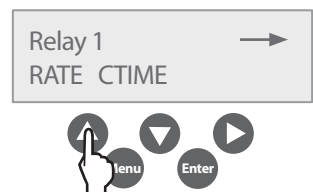

Paso 2b cont.

10. Utilice los teclados ▲ ▼ ► para fijar SET PULSE.
(Nota: Esto será normalmente fijado a +1.00000000). Presione ENTER para salvar.

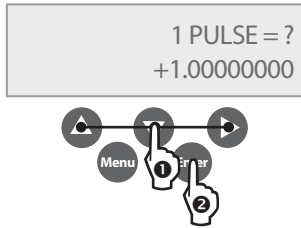

11. Presione ▼ para fijar CLOSETIME.

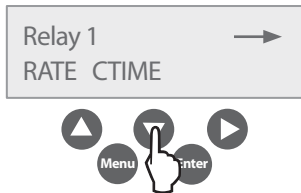

12. Utilice los teclados de ▲ ▼ ► para fijar CLOSETIME.
(Nota: estará normalmente fijado a 100ms). Presione ENTER para salvar.

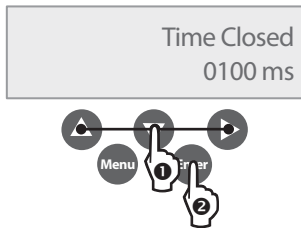

13. Presione MENU tres (3) veces para regresar a la pantalla Flow Total.

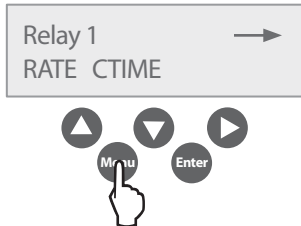

14. La pantalla se verá como a la derecha.

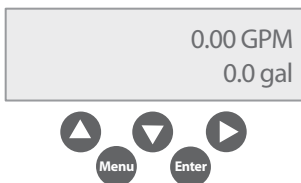

Reconfigurar el 3002 después de presentarse un alto flujo

1. Presione MENU para ingresar el modo de programación. Presione ▲ para ir a la pantalla de reconfiguración.

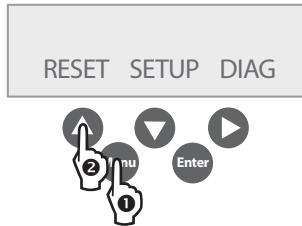

2. Presione ▼ para reconfigurar el Relé.

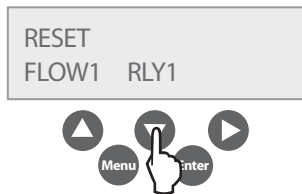

3. Presione ▲ (OK) para reconfigurar.

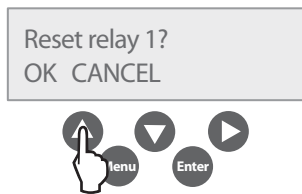

4. Presione MENU dos veces para regresar a la pantalla GPM / Total.

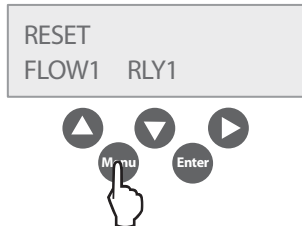

Reconfigurar el 3002 a una lectura total de cero flujo

1. Presione MENU para ingresar el modo de programación. Presione ▲ para ir a la pantalla de reconfiguración.

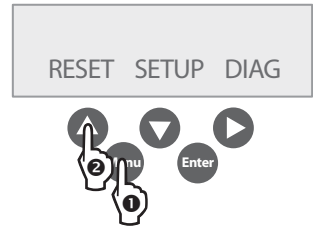

2. Presione ▲ para reconfigurar el flujo (Flow).

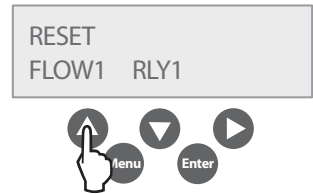

3. Presionar ▲ (OK) para reconfigurar.

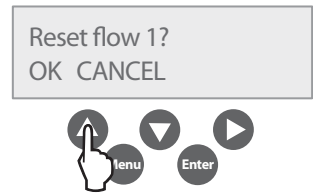

4. Presione MENU dos veces para regresar a la pantalla GPM / Total.

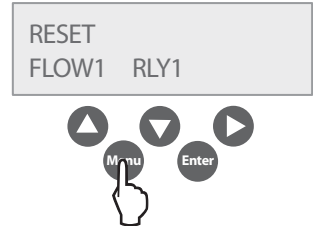

Appendix A *Apéndice A*

For Tee Type Flow Sensors Rain Bird Models FS100B, FS150P, FS200P, FS300P or FS400P use the K & Offset chart below.

Para sensores tipo Te de modelos Rain Bird FS100B, FS150P, FS200P, FS300P o FS400P utilice la tabla K & valores de la parte inferior.

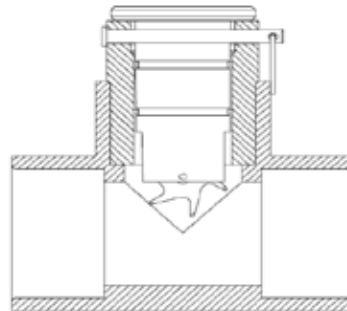

Calibration Table for Tee Mounted Sensors
Tabla de calibración para sensores de montaje en Te

Model	Size	K Value	Offset	Suggested Operating Range (GPM)
FS100B	1"	0.41447	0.41447	2-40
FS100B	1½"	1.848	0.227	3-100
FS100B	2"	2.725	.392	5-200
FS100B	3"	8.309	0.227	12-300
FS100B	4"	15.35	0.248	25-500

Appendix B Apéndice B

For Insert Type Flow Sensors Rain Bird Models FS350B or FS350SS

Para sensores Rain Bird tipo inserto de modelos FS350B ó FS350SS

Calibration Table for Pipe Sizes 3" through 36"

Tabla de calibración para tuberías de 3" a 36"

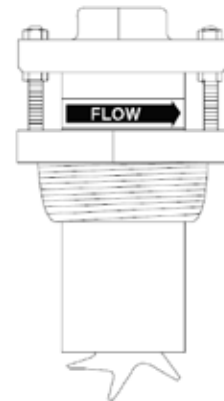

Pipe Size	Pipe O.D.	Pipe I.D.	K Value	Offset	Suggested Operating Range (GPM)
Pipe Size 3" Sch 10S	3.500"	3.260"	5.009	0.090	12-400
Std. Wt., Sch 40	3.5"	3.068"	4.362	0.063	12-400
Extra Strong, Sch 80	3.5"	2.900"	3.858	0.043	12-400
PVC Class 125	3.5"	3.284"	5.094	0.093	12-400
PVC Class 160	3.5"	3.230"	4.902	0.085	12-400
PVC Class 200	3.5"	3.166"	4.682	0.076	12-400
4" Sch 10S	4.5"	4.260"	9.597	0.241	20-600
Std. Wt., Sch 40	4.5"	4.026"	8.34	0.229	20-600
Extra Strong, Sch 80	4.5"	3.826"	7.354	0.188	20-600
PVC Class 125	4.5"	4.224"	9.396	0.240	20-600
PVC Class 160	4.5"	4.154"	9.013	0.240	20-600
PVC Class 200	4.5"	4.072"	8.578	0.239	20-600
5" Sch 10S	5.563"	5.295"	16.305	0.250	30-900
Std. Wt., Sch 40	5.50"	5.047"	14.674	0.248	30-900
Extra Strong, Sch 80	5.50"	4.813"	13.165	0.246	30-900
6" Sch 10S	6.625"	6.357"	24.089	0.260	50-1,500
Std. Wt., Sch 40	6.5"	6.065"	21.574	0.257	50-1,500
Extra Strong, Sch 80 PVC Class 125	6.5"	5.761"	19.457	0.254	50-1,500
Extra Strong, Sch 80 PVC Class 125	6.625"	6.217"	22.853	0.258	50-1,500
PVC Class 160	6.625"	6.115"	21.968	0.257	50-1,500
PVC Class 200	6.625"	5.993"	21.068	0.256	50-1,500
8" Sch 10S	8.625"	8.329"	43.914	0.286	80-2,500
Sch 20	8.625"	8.125"	41.653	0.283	80-2,500
Sch 30	8.625"	8.071"	41.063	0.283	80-2,500
Std. Wt., Sch 40	8.625"	7.981"	40.086	0.281	80-2,500
Sch 60	8.625"	7.813"	38.288	0.279	80-2,500
Extra Strong, Sch 80	8.625"	7.625"	36.315	0.276	80-2,500
PVC Class 125	8.625"	8.095"	41.324	0.283	80-2,500
PVC Class 160	8.625"	7.961"	39.869	0.281	80-2,500
PVC Class 200	8.625"	7.805"	38.203	0.279	80-2,500
10" Sch 10S	10.75"	10.420"	70.195	0.321	125-4,000
Sch 20	10.75"	10.250"	67.668	0.318	125-4,000
Sch 30	10.75"	10.136"	66.069	0.316	125-4,000
Sch 40, Std.Wt.	10.75"	10.020"	64.532	0.314	125-4,000
Extra Strong, Sch 60	10.75"	9.750"	61.016	0.309	125-4,000
Sch 80	10.75"	9.564"	58.644	0.306	125-4,000
PVC Class 125	10.75"	10.088"	65.431	0.315	125-4,000
PVC Class 160	10.75"	9.924"	63.272	0.312	125-4,000
PVC Class 200	10.75"	9.728"	60.733	0.309	125-4,000

Appendix B (cont.) Apéndice B (cont.)

Calibration Table for Pipe Sizes 3" through 36" (cont.)
Tabla de calibración para tuberías de 3" a 36" (cont.)

Pipe Size	Pipe O.D.	Pipe I.D.	K Value	Offset	Suggested Operating Range (GPM)
12" Sch 10S	12.75"	12.390"	104.636	0.367	175-5,000
Sch 20	12.75"	12.250"	102.553	0.364	175-5,000
Sch 30	12.75"	12.090"	99.347	0.360	175-5,000
Std. Wt., Sch 40S	12.75"	12.000"	97.576	0.358	175-5,000
Sch 40	12.75"	11.938"	96.369	0.356	175-5,000
Sch 60	12.75"	11.625"	90.441	0.348	175-5,000
Extra Strong	12.75"	11.750"	92.775	0.351	175-5,000
Sch 80	12.74"	11.376"	85.922	0.342	175-5,000
PVC Class 125	12.75"	11.966"	96.912	0.357	175-5,000
PVC Class 160	12.75"	11.770"	93.152	0.352	175-5,000
PVC Class 200	12.75"	11.538"	88.842	0.346	175-5,000
14" Sch 10S	14.00"	13.500"	122.307	0.391	200-6,000
Sch20	14.00"	13.375"	120.216	0.388	200-6,000
Std. Wt., Sch 30	14.00"	13.250"	118.151	0.385	200-6,000
Sch 40	14.00"	13.124"	116.096	0.382	200-6,000
Sch 60	14.00"	12.814"	111.148	0.376	200-6,000
Extra Strong	14.00"	13.00"	114.098	0.330	200-6,000
Sch 80	14.00"	12.50"	106.299	0.369	200-6,000
16" Sch 10S	16.00"	15.500"	159.243	0.440	300-9,000
Sch 20	16.00"	15.375"	156.742	0.436	300-9,000
Std. Wt., Sch 30	16.00"	15.250"	154.267	0.433	300-9,000
Sch 60	16.00"	14.688"	143.456	0.419	300-9,000
Extra Strong, Sch 40	16.00"	15.000"	149.394	0.427	300-9,000
Sch 80	16.00"	14.314"	136.548	0.410	300-9,000
18" Sch 10S	18.00"	17.500"	202.739	0.498	350-10,000
Sch 20	18.00"	17.375"	199.828	0.494	350-10,000
Sch 30	18.00"	17.124"	194.061	0.486	350-10,000
Std. Wt.	18.00"	17.250"	196.943	0.490	350-10,000
Sch 40	18.00"	16.876"	188.464	0.479	350-10,000
Sch 60	18.00"	16.500"	180.171	0.469	350-10,000
Extra Strong	18.00"	17.000"	191.250	0.482	350-10,000
Sch 80	18.00"	16.126"	172.152	0.457	350-10,000
20" Std. Wt., Sch 20	20.00"	19.25"	246.179	0.555	400-12,000
Sch 40	20.00"	18.812"	234.836	0.540	400-12,000
Extra Strong, Sch 30	20.00"	19.000"	239.666	0.547	400-12,000
Sch 80	20.00"	17.938"	213.140	0.511	400-12,000
22" Std. Wt., Sch 20	22.00"	21.25"	301.975	0.621	500-15,000
Extra Strong, Sch 30	22.00"	21.00"	294.642	0.616	500-15,000
Sch 80	22.00"	19.75"	259.513	0.573	500-15,000

Calibration Table for Pipe Sizes 3" through 36" (cont.)

Tabla de calibración para tuberías de 3" a 36" (cont.)

Pipe Size	Pipe O.D.	Pipe I.D.	K Value	Offset	Suggested Operating Range (GPM)
24" Std. Wt., Sch 20	24.00"	23.25"	364.331	0.666	600-18,000
Extra Strong	24.00"	23.00"	356.178	0.660	600-18,000
Sch 40	24.00"	22.624"	344.109	0.652	600-18,000
Sch 80	24.00"	21.562"	311.271	0.628	600-18,000
26" Sch 10	26.00"	25.376"	437.809	0.719	700-21,000
Std. Wt.	26.00"	25.25"	433.247	0.716	700-21,000
Sch 20, Extra Strong	26.00"	25.00"	424.274	0.709	700-21,000
28" Sch 10	28.00"	27.376"	513.698	0.774	900-23,000
Std. Wt.	28.00"	27.25"	508.723	0.770	900-23,000
Extra Strong, Sch 20	28.00"	27.00"	498.930	0.763	900-23,000
30" Sch 10	30.00"	29.376"	596.147	0.833	1,000-30,000
Std. Wt.	30.00"	29.25"	590.759	0.829	1,000-30,000
Sch 20, Extra Strong	30.00"	29.00"	580.146	0.822	1,000-30,000
32" Sch 10	32.00"	31.376"	685.156	0.897	1,200-35,000
Std. Wt.	32.00"	31.25"	679.355	0.893	1,200-35,000
Sch 20, Extra Strong	32.00"	31.00"	667.922	0.885	1,200-35,000
Sch 40	32.00"	30.624"	650.919	0.873	1,200-35,000
34" Sch 10	34.00"	33.312"	777.566	0.964	1,300-40,000
Std. Wt.	34.00"	33.25"	774.511	0.962	1,300-40,000
Extra Strong, Sch 20	34.00"	33.00"	762.258	0.953	1,300-40,000
Sch 40	34.00"	32.624"	744.022	0.940	1,300-40,000
36" Sch 10	36.00"	35.376"	882.855	1.040	1,500-45,000
Std. Wt.	36.00"	35.25"	876.227	1.035	1,500-45,000
Sch 20, Extra Strong	36.00"	35.00"	863.154	1.025	1,500-45,000
Sch 40	36.00"	34.50"	837.315	1.007	1,500-45,000