

CISTERN TANK OVERVIEW

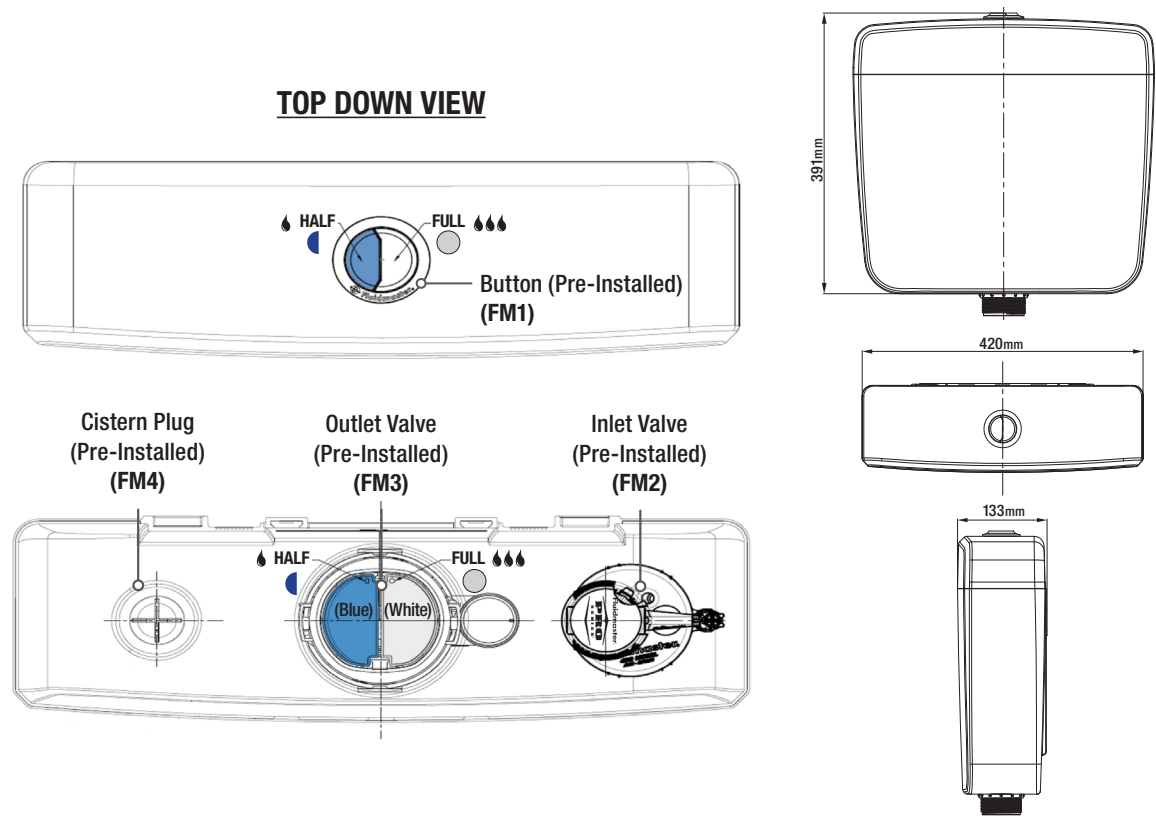

PARTS OVERVIEW

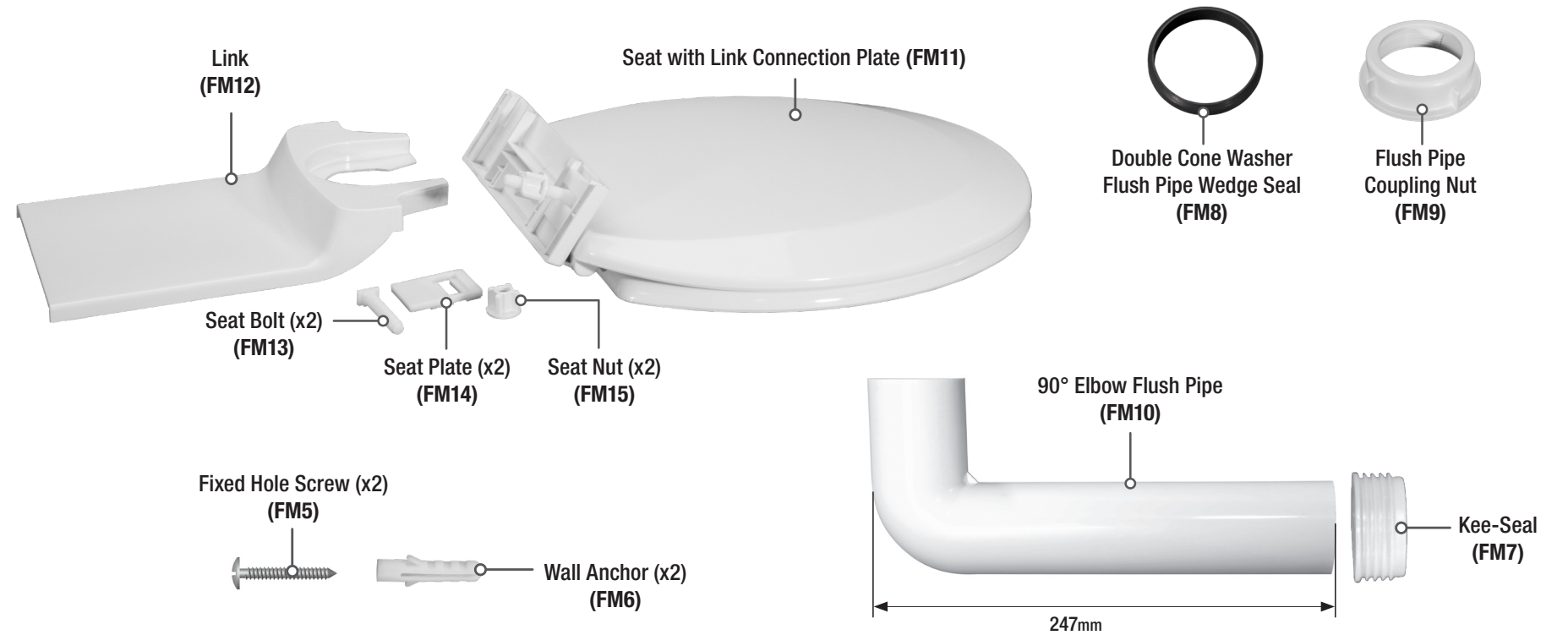

PRE-INSTALLATION

A: OPEN LID

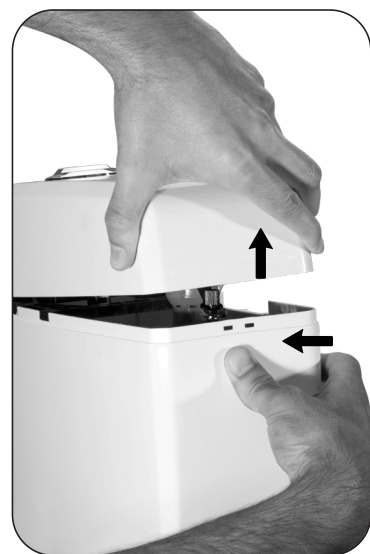

B: FLUSH VOLUME CONVERSION

CONVERTING TO 6/3L OR 9/4.5 FLUSH VOLUME SYSTEM

B1: Remove black cistern tank spacer.

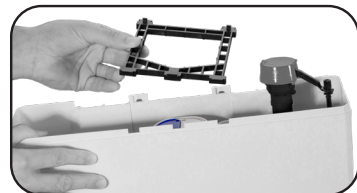

B2: Remove flush valve body & adjust full and half float settings per Flush Volume Conversion Table.



*Pre-set flush volume settings = 4.5/3L system.
For pairing to a 4.5/3L pan, no flush volume setting adjustment is required.

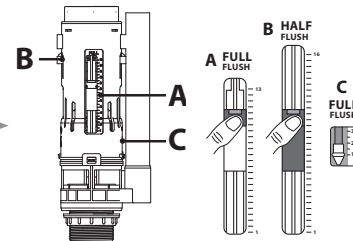

CISTERN FLUSH VOLUME CONVERSION SETTINGS

	4.5/3L	6/3L	9/4.5L
A Full Float #	9.5	5	1
B Half Float #	12.5	12	9
C Full Window #	1	1	1

B3: Re-install flush valve body and black cistern tank spacer. Ensure proper full and half flush alignment.

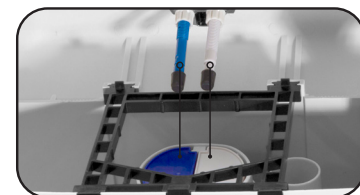

NOTE:
 (Blue) = Half Flush
 (White) = Full Flush

STEP 1: MARK WALL FOR SCREW HOLES

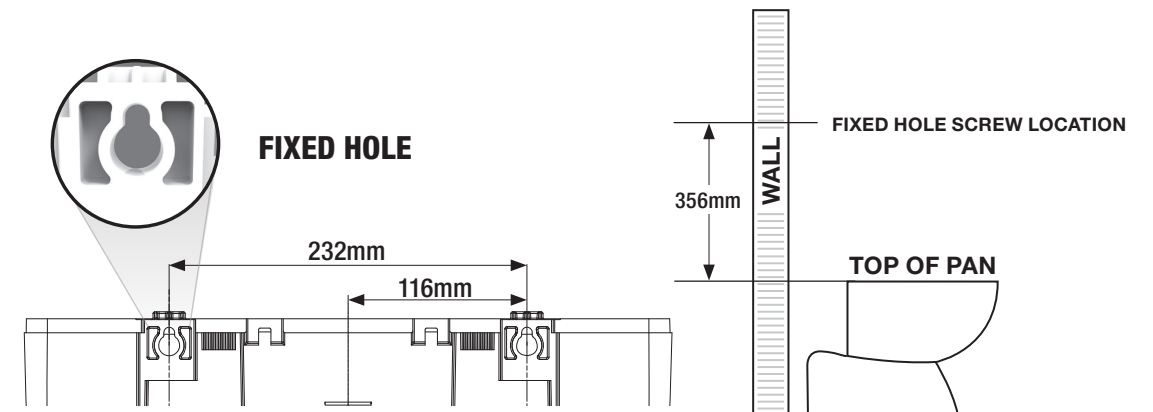
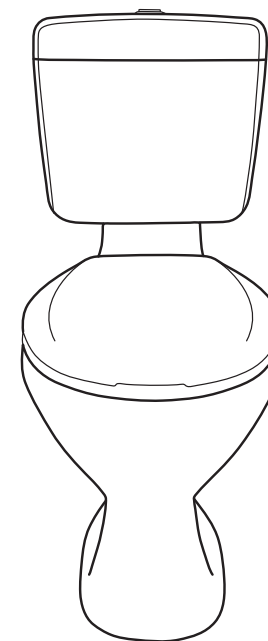

STEP 2: SET SCREWS

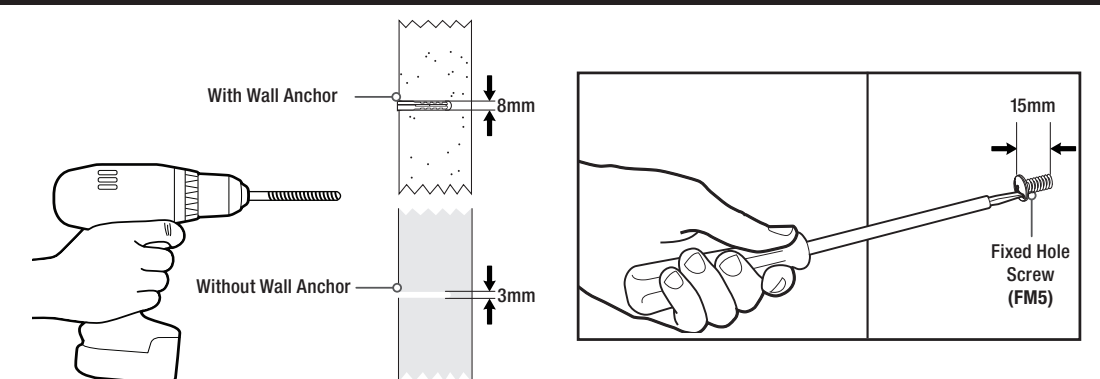

STEP 3: INSTALL FLUSH PIPES

A: Trim / Cut Flush Pipe as needed.



B: Lubricate kee-seal with soap and water. Insert flush pipe and connect to pan.

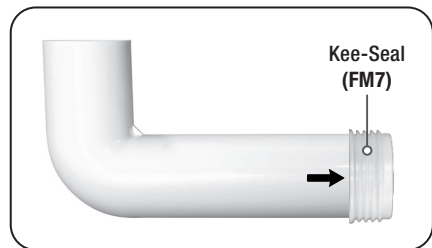

C: Fit Flush pipe coupling nut and double cone washer wedge seal onto flush pipe. Hand-tighten Flush pipe coupling nut and secure flush pipe to outlet valve shank. **DO NOT OVERTIGHTEN**

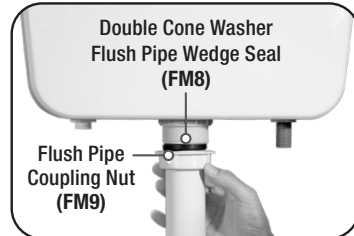
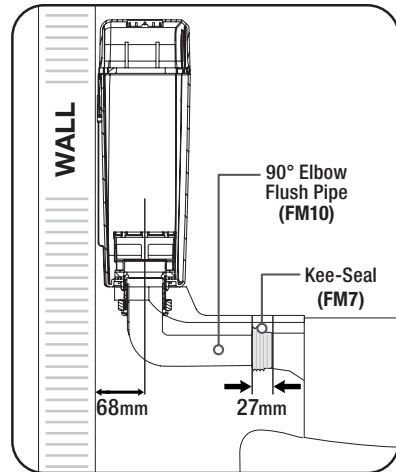

STEP 4: HANG CISTERN TANK

FIXED HOLE

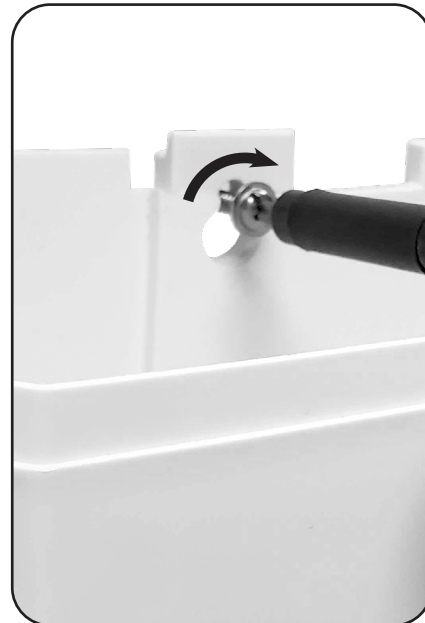

STEP 5: WATER SUPPLY CONNECTION & FINE-TUNE TANK WATER LEVEL

A: Turn on water & flush water supply line.



B: Turn off water & connect water supply line to cistern with approved fittings. Hand-tighten only. **DO NOT OVERTIGHTEN.**



C: Turn on water & check for leaks.



D. FLUSH THE CISTERN TO CHECK THE TANK WATER LEVEL
After the water stops filling the tank, the water level should be at water line "WL" mark (255mm) to ensure a proper flush.

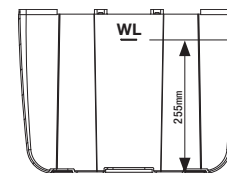

STEP 6: ATTACH LINK (IF REQUIRED)

A: Secure link into position.

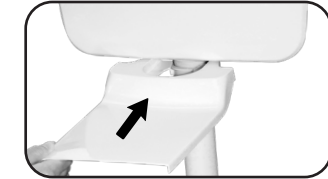

B: Set seat onto link to mark desired seat end point & cut point.

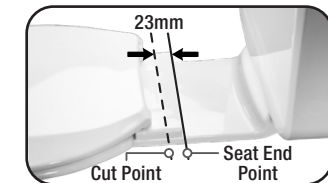

C: If cut required, cutting line guides reference on back of link as needed.

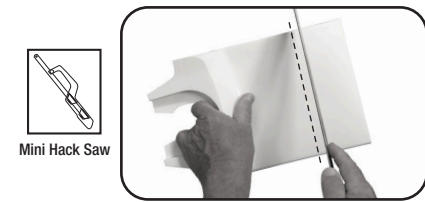

INSTALLATION

STEP 7: INSTALL SEAT

A: Insert Seat Bolt Plates in Connection plate (follow arrow guides).

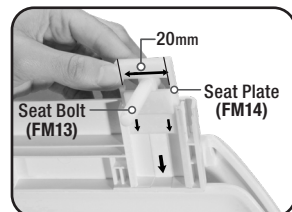

For Link Application

Insert link to seat connection plate. Set seat bolts into pan holes and hand-tighten seat bolt nuts.

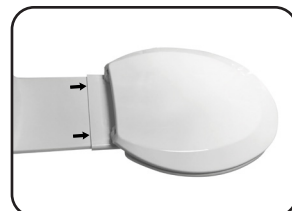

For Non-Link Application

Set seat bolts into pan holes and hand-tighten seat bolt nuts.



STEP 8: ATTACH / RE-SECURE LID

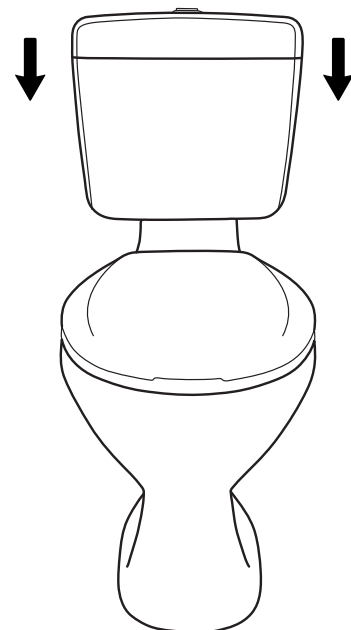

IF THE INLET VALVE:

- DOES NOT TURN ON
- WON'T TURN OFF
- WON'T REFILL TANK

REMOVE CAP AND CHECK FOR DEBRIS

- A:** Turn off water supply.
B: Flush cistern.
C: With right hand push float up, grip and hold shaft under float.
D: With left hand twist cap and lever arm counterclockwise to unlock cap. Let cap hang on float cup.
E: Hold empty cup upside down over uncapped valve to prevent splashing.
F: Turn water supply on and off a few times.
G: Turn water supply off.
H: Replace valve cap.
- Place cap assembly on top of gray valve body by aligning cap arm and adjustment rod.
 - Press down on top cap while rotating top & arm clockwise to locked position.

* Always use genuine Fluidmaster parts when installing or repairing. Fluidmaster will not be responsible or liable for use of non-Fluidmaster parts during installation or repair.

TROUBLESHOOTING



See Our Troubleshooting HOW-TO VIDEO
<http://bit.ly/2yAdZn7>



WARNING



DO NOT USE IN-CISTERN DROP-IN TOILET BOWL CLEANERS CONTAINING BLEACH OR CHLORINE. Use of such products will: (1) RESULT IN DAMAGE to Cistern components and MAY CAUSE FLOODING and PROPERTY DAMAGE and (2) VOID FLUIDMASTER WARRANTY. DO NOT overtighten nuts or cistern/bowl may crack. Always use quality Fluidmaster parts when installing or repairing. Fluidmaster will not be responsible or liable for use of non-Fluidmaster parts during installation or repair.

WARRANTY

Our goods come with guarantees that cannot be excluded under the Australian Consumer Law. You are entitled to a replacement or refund for a major failure and for compensation for any other reasonably foreseeable loss or damage. You are also entitled to have the goods repaired or replaced if the goods fail to be of acceptable quality and the failure does not amount to a major failure.

To present claims under this warranty, please contact your place of purchase or contact Fluidmaster Australia Holdings Pty Ltd. **NOTE:** Original proof of purchase required.

Warranty excludes incorrect installation. Installation shall be in accordance with AS/NZS 3500.1 and AS/NZS 3500.2 (Install with licensed plumber; any installation processed without licensed plumber will void warranty) 5 Year Parts Replacement / 1 Year Parts & Labor. For Commercial = 1 Year Parts Replacement.

Only clean with soap and warm water to maintain quality finish. Do not use harsh chemical cleaners.

ADDITIONAL QUESTIONS?

For installation assistance, contact our technical services department. **EMAIL**, or **CALL** our toll-free number.

Phone: +61 (0)3 8870 2555 | Toll Free: 1 800 931 166
IN NEW ZEALAND Call 09 415 5585
Email: salesau@fluidmaster.com
Website: www.Fluidmaster.com.au



Fluidmaster
Fluidmaster Australia Holdings Pty Ltd
5B/100 New Street
Ringwood, Victoria 3134
Australia