

John Guest Speedfit Limited

Horton Road, West Drayton, Middlesex UB7 8JL, England.
Tel: 01895 449233. Fax: 01895 420321. www.speedfit.co.uk
Technical Help Desk: 01895 425333

The company has a policy of continuous research and development and reserves the right to amend without notice the specification and design of all products illustrated in this catalogue. For further details of terms and conditions, please contact our Customer Services Department. Subject to Terms and Conditions of Sale available on request.

JG John Guest® and **JG Speedfit®** are registered trademarks of **John Guest International Limited**
© Copyright 2006.



AVAILABLE FROM

JE Speedfit®

THE PUSH FIT SOLUTION FOR PLUMBING AND HEATING SYSTEMS



FEATURING
NEW
UNDERFLOOR
HEATING

**UK PRODUCT RANGE AND
INSTALLATION GUIDE
JANUARY 2006**

Speedfit[®]

**THE PUSH-FIT SOLUTION FOR
PLUMBING AND HEATING SYSTEMS**

PLUMBING AND HEATING **PAGES 17 - 18**



UNDERFLOOR HEATING SYSTEMS **PAGES 49 - 52**



FITTINGS FOR COLD WATER SERVICES

PAGES 53 - 56



NEW PRODUCTS



PAGE 25



PAGE 22



PAGE 30



PAGE 49

JG John Guest®

Worldwide connections

The John Guest Group has a long established reputation as a world leading manufacturer of push-in fittings, tube and other fluid control products. A reputation built on producing consistently high quality products with an ongoing commitment to value engineering and product development.



Quality Manufacture

A commitment to quality is at the heart of the John Guest Philosophy.

The strictest control is maintained by virtue of the fact that design and manufacture is carried out in modern purpose built manufacturing centres in west London and at Maidenhead in Berkshire.

Maintaining control over the whole process from initial tool design and tool making through to final assembly and testing ensuring that only products of the highest quality are produced.

The company believe it is this commitment to quality that has led to it receiving prestigious awards from many of the world's leading testing and approvals organisations.

John Guest is a preferred supplier to many international companies.



THE PUSH-FIT SOLUTION FOR PLUMBING AND HEATING SYSTEMS

JG Speedfit is a push-fit system suitable for the plumbing of normal domestic hot and cold water services and central heating applications, including pressurised and combi systems.

Speedfit Fittings have been designed for use with both Speedfit and copper pipe, in diameters of 10mm to 28mm.



They are approved by the British Board of Agrément and Water Regulations Advisory Scheme. Speedfit 'PEM' fittings and PEX and Polybutylene Barrier Pipe are Kitemarked to BS7291 Parts 1, 2 and 3 Class S Licence No KM39767.

Speedfit fittings and barrier pipe offer a complete system of plastic plumbing. They are manufactured to comply with BS7291 Parts 1, 2 and 3 Class S.

Performance specifications are well within those required for most normal domestic central heating and water supply systems including:

- Mains fed and indirect cold water systems
- Vented and unvented hot water systems
- Vented central heating systems
- Sealed central heating systems provided temperatures and pressures comply with BS7291 Parts 1, 2 and 3 Class S.
- Underfloor heating

STANDARDS AND AFFILIATIONS



Speedfit Fittings and pipe are Kitemarked to BS 7291 Parts 1, 2 and 3



ISO 14001



PEX Fittings and Barrier Pipe K24076, K24077, K24078

Extensive tests have shown that Speedfit products will withstand temperatures and pressures well in excess of normal working conditions.

JG Speedfit should be installed to conform with good plumbing practice.

British Gas Service has accepted the John Guest Speedfit System as being suitable for open vented and sealed central heating systems and as eligible for acceptance onto its service contracts.

25 YEAR GUARANTEE

As a result of its long term test programmes and rigorous quality standards John Guest Speedfit Limited offer a 25 year guarantee against defects in materials or manufacturing of 'PEM' range plumbing fittings and Speedfit Barrier Pipe manufactured by John Guest.

John Guest Underfloor Heating Products, which should be installed and maintained in accordance with our recommendations, carry a 2 year guarantee against defects in materials and manufacture.

John Guest Plumbing and Heating Products are for use with with normal UK domestic plumbing and heating systems and supplied in accordance with our Conditions of Sale.

SYSTEM FEATURES

- All white system
- Truly demountable without damage to pipe or fitting
- Grip and seal connection
- Superseal Insert gives secondary seal
- Reduced pipe insertion force
- Lightweight and easy to handle on site

SYSTEM BENEFITS

- Installation time reduced by up to 40%
- Pipe flexibility permits the cabling of pipe through less accessible areas
- No risk of fire or flames from a blowtorch
- Easier to work in confined places
- A permanent leak-proof connection
- Corrosion free
- No scale build up
- Lower thermal diffusivity maintains safer surface temperature
- Pipe elasticity can reduce the possibility of bursting under freezing conditions
- Lead free and non toxic
- Less noise from water flow and expansion/contraction
- Long pipe lengths reduce fittings required

SPECIAL APPLICATIONS

Boats. The flexibility of the Speedfit System ensures it can be cabled easily around the interior and hidden from view.

Caravans. Speedfit is ideal for caravan installations due to its flexibility and its resistance to corrosion and freezing.

Exhibitions. The unique ability of the Speedfit System to be easily demounted and reused, together with its flexibility, makes Speedfit ideal for this application.

Agricultural and Horticultural. Speedfit has many applications in agricultural and horticultural environments.

Portable Buildings (site cabins, toilets). As with caravans, Speedfit is well suited to this application.

WORKING TEMPERATURES AND PRESSURES

Application	Usual working temperature, °C	Maximum working temperature, °C	Maximum working pressure, bar
Cold Water (indirect and direct mains)	20	20	12
Central Heating	82	105, short term malfunction at 114	3
Hot Water (including unvented cylinders)	65	95	6

Speedfit fittings suitable for central heating systems can withstand temperatures up to 114°C intermittently for short periods.

Speedfit fittings shown as not suitable for central heating systems are used primarily on the domestic hot and cold water system accepting temperatures of up to 65°C.

HANDLING FITTINGS AND PIPE

Ensure fittings and pipe are kept clean at all times by keeping them in bags and boxes provided.

Do not empty Speedfit Products onto the floor area.

Ensure internal 'O' Ring seals are kept free from dirt and debris.

To remove pipe from the bag, use a Band Cutter shown on page 32 rather than an open blade.

PRODUCT SELECTION AND INSTALLATION

John Guest fittings and related products are specifically designed and manufactured by John Guest to the Technical Specifications set out in the John Guest Product Catalogues. All John Guest fittings and related products should be selected, installed, used and maintained in accordance with these Technical Specifications. It is the customer's / user's responsibility to ensure that John Guest fittings and related products are suitable for their intended applications, are properly installed and maintained and are used in accordance with the Technical Specifications. It is also the customer's / user's responsibility to provide it's own customers with any relevant technical information about John Guest products it supplies them.

Speedfit should not be used for gas, fuel oil or compressed air applications.

John Guest produce a push fit system of pipe and fittings for compressed air situations. See separate literature for details.

HOW SPEEDFIT WORKS

Speedfit Fittings have a unique grip then seal construction made up of a collet with stainless steel teeth to grip the pipe and an 'O' ring to provide a permanent leak proof seal.

Use of the Superseal Pipe Insert ensures a double 'O' ring seal.

An 'O' ring at the head of the insert and the shape of the stem, provide a secondary seal against the bore of the fitting. A combination of this and the main 'O' ring ensure a good connection.

The stem of the insert gives greater rigidity of the length of pipe within the fitting, reducing the chance of leaks if a side load is applied.

The head of the insert has been designed for ease of insertion.

The additional benefit of Twist and Lock Fittings is that a twist of a screwcap locks the pipe in position and gives increased compression on the 'O' ring for even greater security.

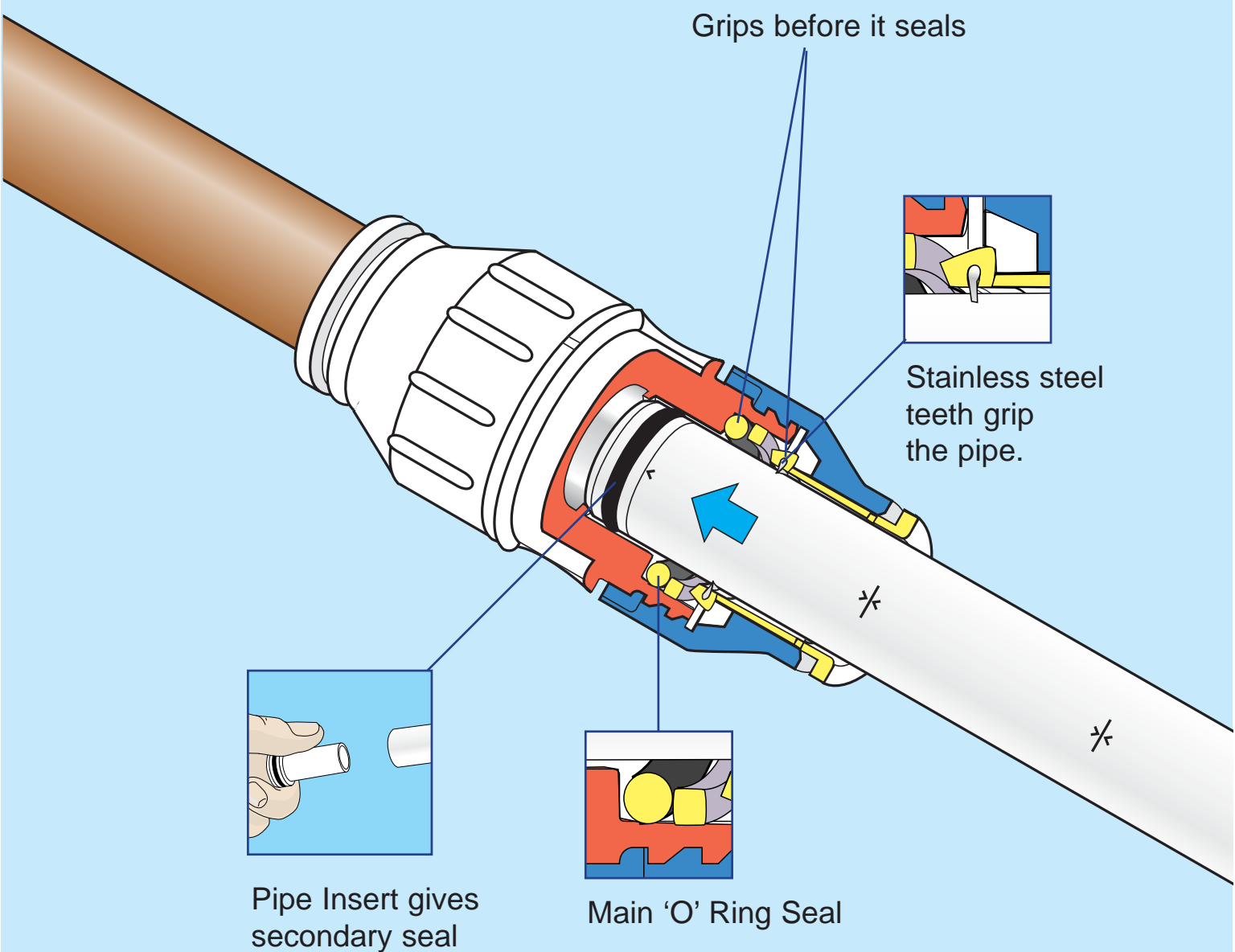

MAKING A GOOD CONNECTION

Fittings and pipe should be kept clean, bagged and undamaged before use.

PREPARE THE PIPE

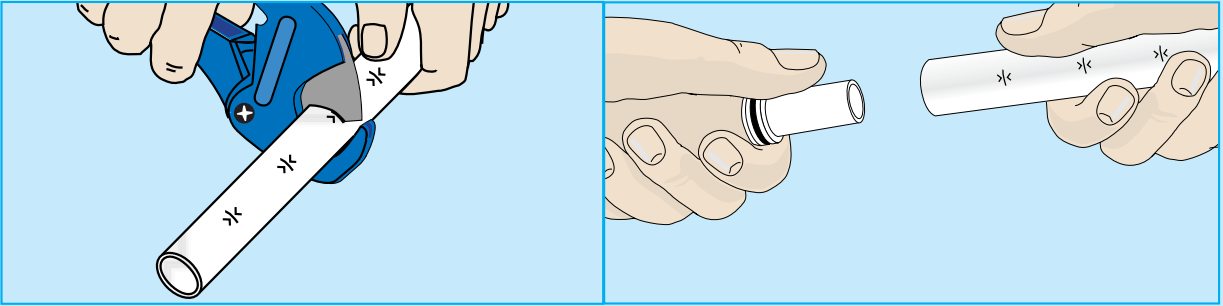

Ensure the pipe is free of score marks. Cut the pipe square. When using Speedfit Barrier Pipe cut along an insertion mark. We recommend the use of JG Pipe Cutters.

To prevent damage to the 'O' ring remove all burrs and sharp edges. When using Speedfit Pipe use a Superseal Pipe Insert. The insert should only be used with Speedfit Pipe.

NEW TWIST AND LOCK FITTINGS

The fitting should be in the 'unlocked' position, this is shown by a small gap between the screwcap and the body flange.

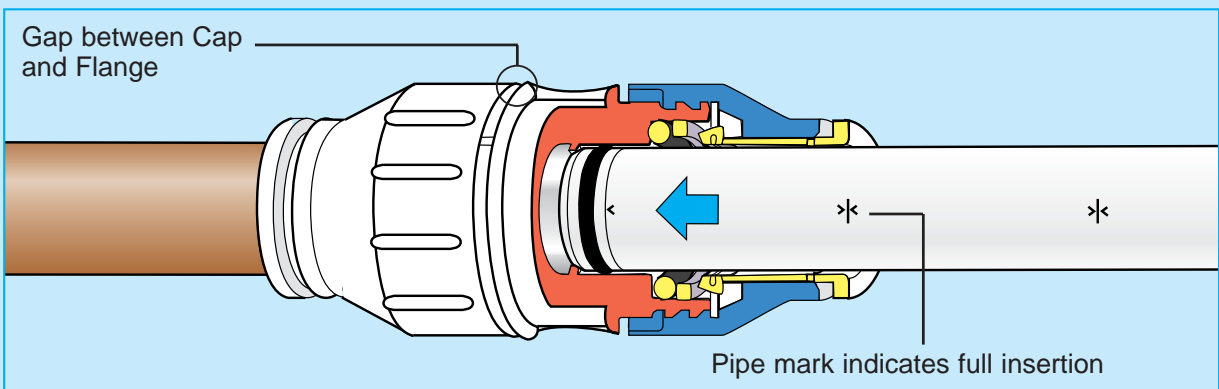

Push the pipe into the fitting, up to the pipe stop. If the Speedfit Pipe has been cut correctly the insertion mark on the pipe will be level with the collet head. The 'O' ring on the Superseal Pipe Insert provides a secondary seal against the bore of the fitting. **A good connection has been made.**

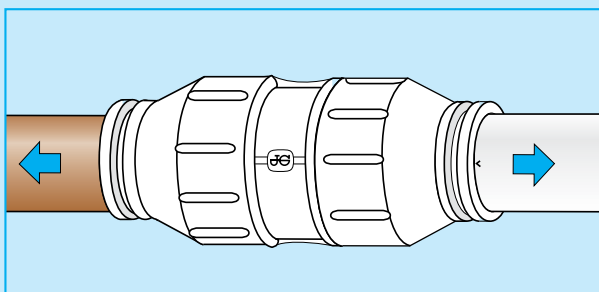

If you are not using collet clips, (see page 11) ensure that the screwcaps are in the locked position.

Pull to check it is secure. It is good practice to test the system prior to leaving the site or before use. Our recommended test procedure is shown in our Technical Checklist.

ADDED BENEFIT OF TWIST AND LOCK

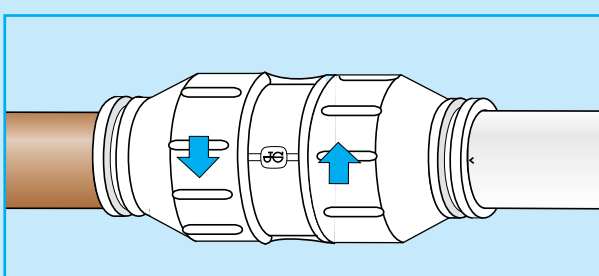

Twist the screwcap until it touches the body flange. This locks the pipe into position and increases the 'O' ring seal around the pipe for greater security.

STANDARD FITTINGS

Standard Speedfit connections are made in the same way as Twist and Lock.

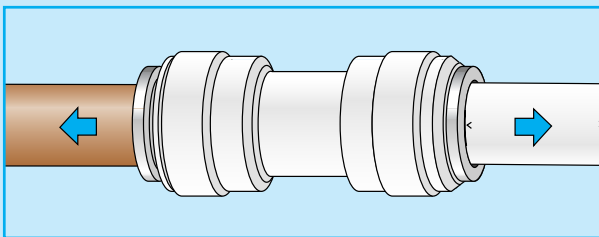
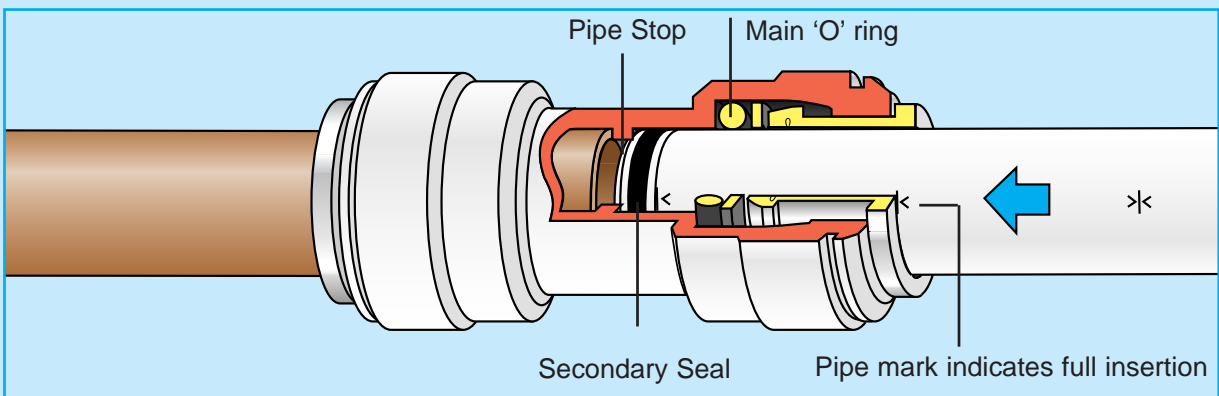

Pull to check the connection is secure. It is good practice to test the system prior to leaving the site or before use.

Our recommended test procedure is shown in our Technical Checklist.

TO DISCONNECT

Ensure the system is depressurised.

The screwcap on Twist and Lock fitting will need to be turned back to the unlocked position.

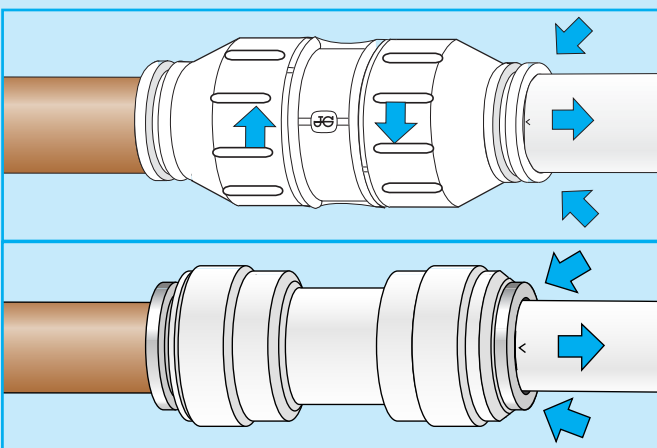

Push the collet square against the face of the fitting by using fingers or with the help of our collet release tool.

With the collet held in this position the pipe can be removed.

The fitting can be used again without the need for replacement parts.

WHAT NOT TO DO

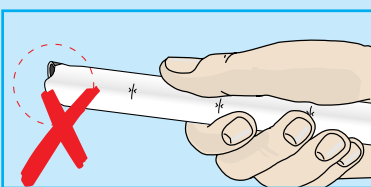

Don't use damaged or scored pipe.

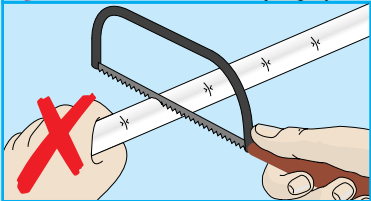

Don't use hacksaws to cut the pipe or leave burrs on the end of the pipe.

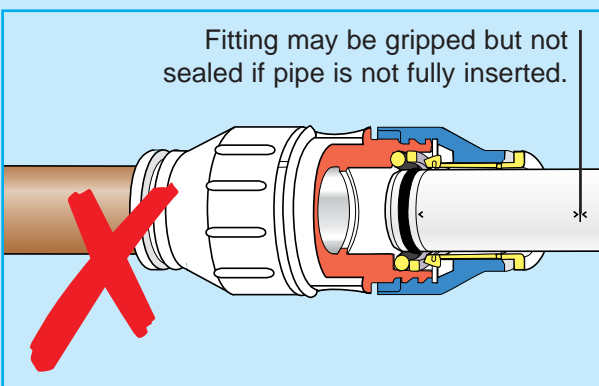

Don't forget to push the pipe fully into the fitting, past both the collet (gripper) and the 'O' ring.

Do not insert fingers into the fitting as the stainless steel teeth may cause injury.

Remember to pressure test the completed installation according to the recommendations in our Technical Checklist.

PIPE STOP DISTANCES

Stops are located at the following distances from the end of the fitting:

Size	10mm	15mm	22mm	28mm
Stop Distance	20mm	30mm	35mm	44mm

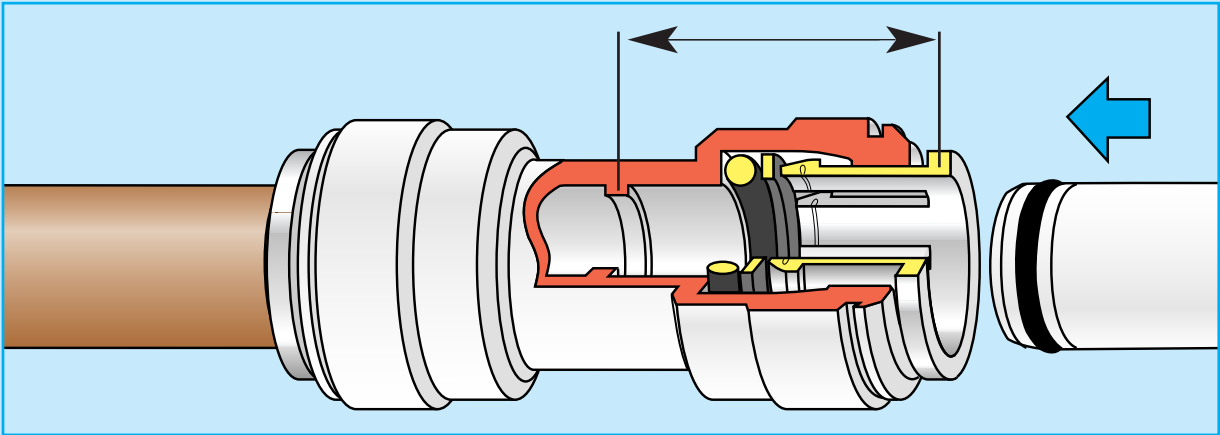

COLLET COVERS AND COLLET CLIPS

Use a collet cover or collet clip to provide added security against pipe disconnection, e.g. the fitting coming into contact with rigid surfaces and behind dry-lining walls.

Collet covers for use with standard Speedfit fittings, are available in white or in red or blue to allow colour coding of pipes.

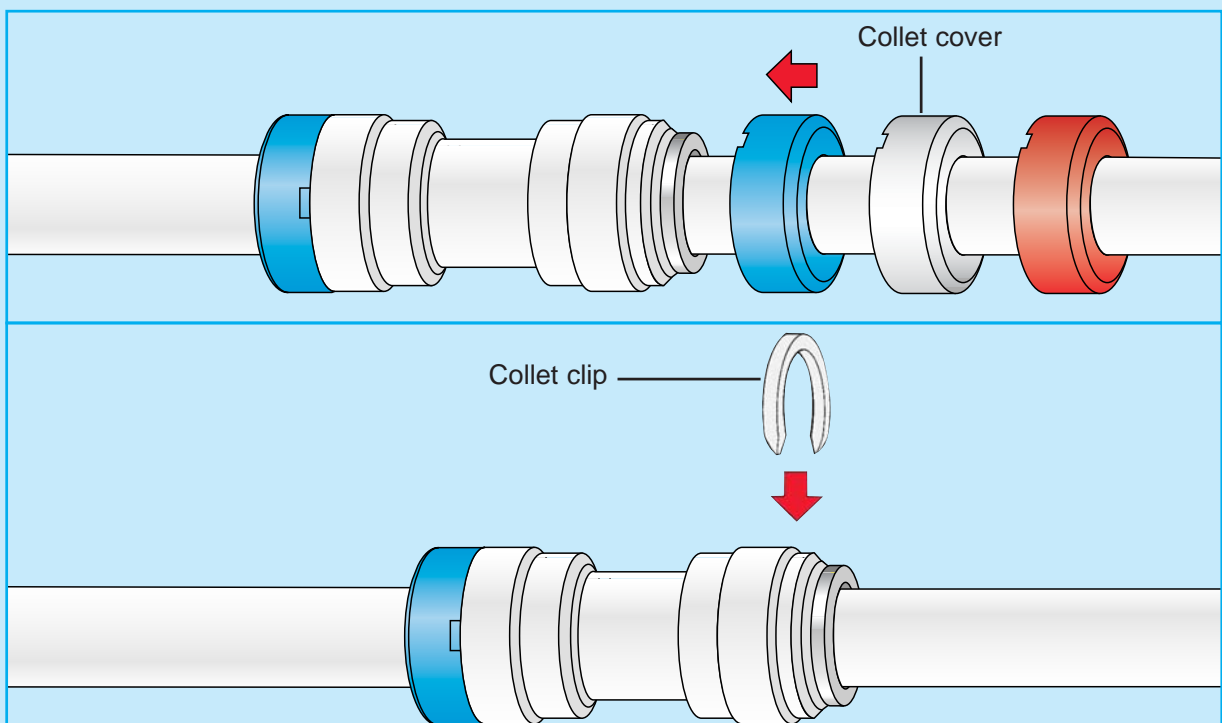

White or grey collet clips are used with standard fittings to prevent accidental pipe disconnection.

Red or Blue collet clips provide colour coding of pipe on Twist and Lock fittings. They are not designed to prevent accidental release and should be fitted when the fitting is in the locked position.

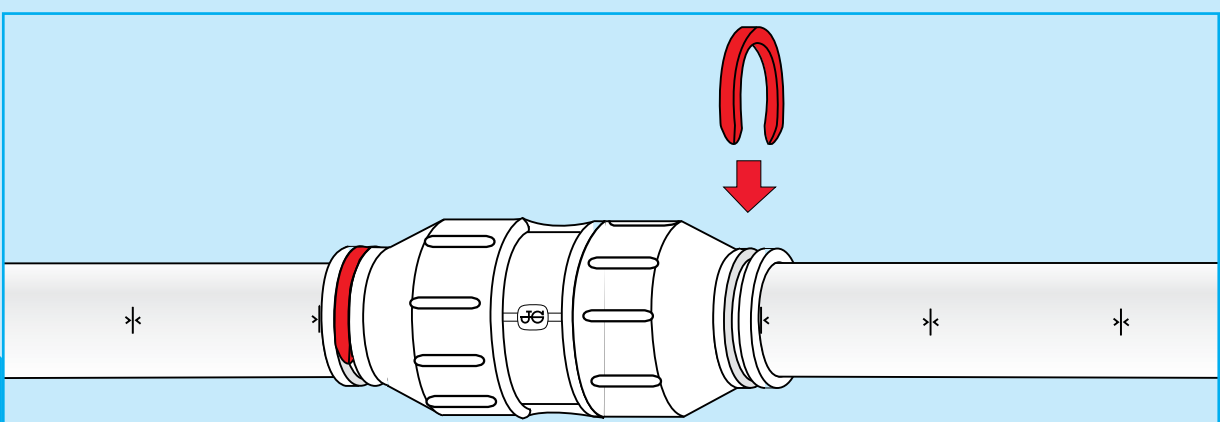

RELEASE AID

The action of pressure in a system could increase the grip of the collet. The release aid allows a firmer grip on the collet whilst removing the pipe.

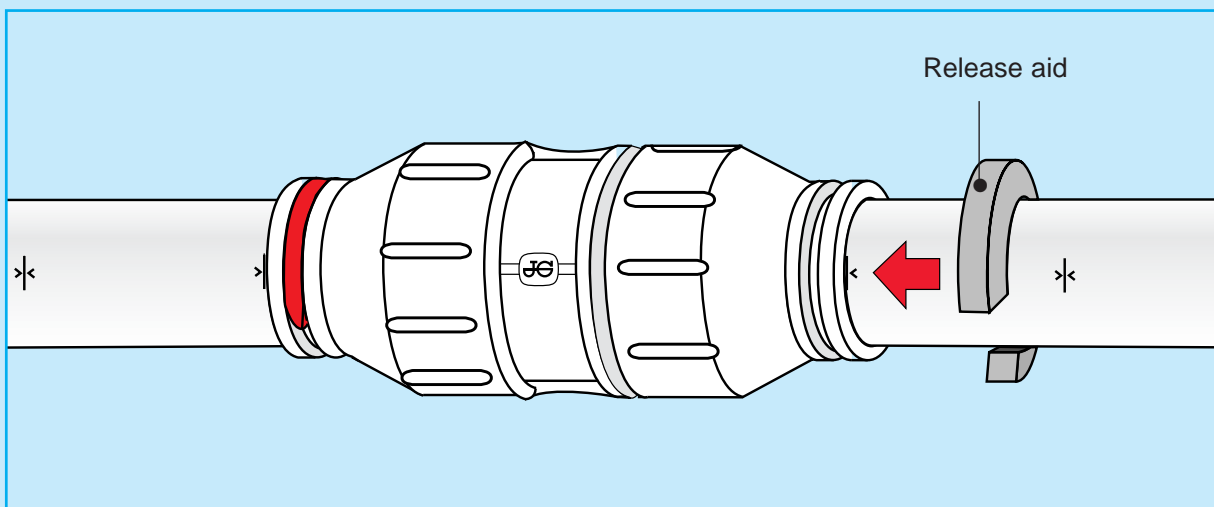

STOP END

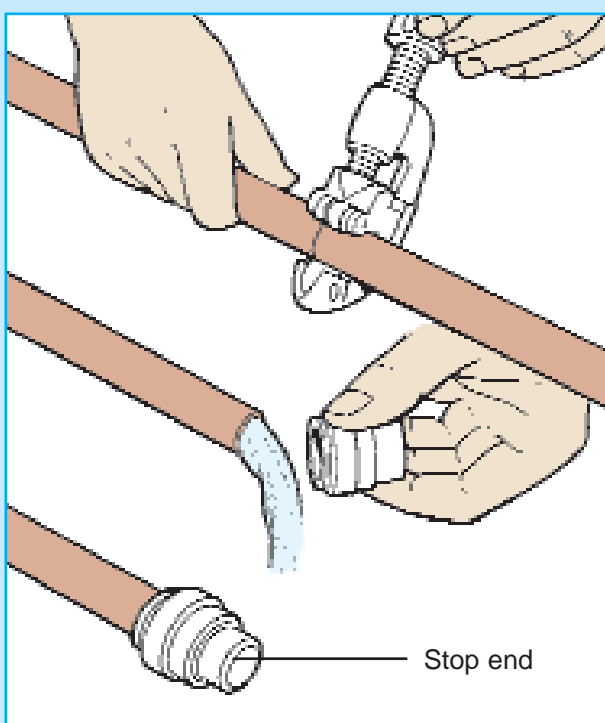

The unique feature of the Speedfit Concept, the ability to disconnect the fitting should you want to, means the Speedfit Stop End not only provides a permanent leakproof seal, but can be readily removed to allow work to restart or to allow an extension to a system. Thus, the fitting is especially useful to allow water to be turned back on, overnight for instance, or if a job has to be interrupted for another reason.

Stop ends are also useful when pressure testing a system before appliances are connected.

STEM ELBOW



Designed to simplify pipe connection in restricted spaces. The Speedfit Stem Elbow provides an instant swivel fitting so pipe can be orientated in any direction.

A special 10mm version gives a neat connection from concealed plumbing to a radiator.

SERVICE VALVES

The Speedfit range of brass chromium plated service valves can be used on both hot and cold water services and central heating. Push fit connections mean much reduced installation time, especially in confined spaces.



The valves, in 10 to 22mm, have a 1/4 turn open/close mechanism operated by a screwdriver slot or a lever.

Tap connector patterns have a union nut to connect direct to a tap or float valve. Lever operated valves are supplied with both a blue and a red indice.



The ability of Speedfit products to twist whilst in situ allows the screwdriver slot operating valve to be turned out of sight, helping to avoid unauthorised tampering.

TAP CONNECTORS

Speedfit manufacturer a wide range of connectors including conventional straight and bent tap connectors.



The range also offers a special and unique Tap Connector that only requires a simple hand tightening to connect up a terminal tap, mixer or a float valve. An integral seal within the fitting avoids the need for further sealant. The connectors are useful when replacing existing brassware or in other confined spaces.



Coupling up to a supply is easy. The pipe is simply pushed home into the Speedfit connection and is instantly secured, without the need for specialist tools.

SPEEDFIT MANIFOLD

Speedfit have introduced an innovative 22mm x 10mm 4 way manifold. Departing from the usual manifold design, this new product has 4 in-line 10mm outlets, offering a neater envelope size and therefore a much smaller installation space.

Other benefits include better flow characteristics and a more even distribution of hot water.

The 22mm and 10mm Speedfit push-fit connections make for a fast and easy installation, even in confined spaces.

Whilst designed as heating product, the manifold can also be used in a mains pressure hot or cold domestic plumbing system, to feed bathroom or kitchen taps and mixers. This allows for a more efficient installation as every terminal fitting has its own dedicated supply.



FLEXI HOSES

Manufactured to a quality you would expect from Speedfit, our range of Flexi Hoses has 37 different patterns.

Available in lengths from 150mm to 1,000mm, ends are either push fit to union nut or push fit to push fit, including hoses with an integral service valve operated by a 1/4 turn screwdriver slot.



The hoses are suitable for hot and cold water services, have a working pressure of 10 Bar, a burst pressure of 40 Bar and have WRAS and NHBC Approval.



More specialist patterns have been designed to help the installation of monobloc mixers to a 15mm supply. Sold in pairs, each hose in the pair has a different spanner location to ease connection of the threaded end into the monobloc's inlets.



APPLIANCE TAPS

The Speedfit Range includes an Appliance Tap for the permanent connection of washing machines and dishwashers, thus enabling complete water isolation to the appliances.



A simple push fit connection of the supply pipe and a plastic thread on the outlet to marry well with the plastic thread on the hose means the Speedfit Appliance Tap is very easy to install. The large round handle is easy to grip and turn.

SUPERSEAL PIPE INSERT

The Superseal Pipe Insert has been developed to be used with Speedfit Barrier Pipe and Speedfit Fittings to provide an extra line of defence when installing a Speedfit Push Fit System.

The insert has its own 'O' ring which, together with a stem sliding within the inside diameter of the pipe. Gives a secondary seal against the inside of the fitting.



The Speedfit Connection, when made with the insert, has a number of design features.

Sliding the stem of the insert into the pipe gives greater compression of the main 'O' ring on the pipe and greater rigidity of the length of pipe within the fitting, reducing the chance of leaks if a side load is applied.

A connection is easier to make because the head of the insert has been designed for ease of insertion.

Superseal Inserts are listed on page 31.

PLUMBING FITTINGS

EQUAL STRAIGHT CONNECTOR



PART No.	SIZE MM	BAG QTY	Box QTY
PEM0410W	10	10	150
PEM0415W	15	10	60
PEM0422W	22	5	30
PEM0428W	28		25

Suitable for central heating systems.

REDUCING STRAIGHT COUPLER



PART No.	SIZE MM	BAG QTY	Box QTY
PEM201510W	15 x 10	10	80
PEM202215W	22 x 15	5	40

Suitable for central heating systems.

PE-COPPER COUPLER



Used to connect PE Pipe to Speedfit or to Table X or Y Copper.

Taken from the Speedfit Underground Fittings Range, see separate section for details and Technical Specification.

PART No.	SIZE MM	BAG QTY	Box QTY
JG601B	20 x 15	20	120
JG603B	25 x 15	20	150
JG602B	25 x 22	20	120

Cold water only.

EQUAL ELBOW



PART No.	SIZE MM	BAG QTY	Box QTY
PEM0310W	10	10	150
PEM0315W	15	10	50
PEM0322W	22	5	25
PEM0328W	28		15

Suitable for central heating systems.

STEM ELBOW



Provides a swivel type connection.



PART No.	PIPE MM	STEM MM	BAG QTY	Box QTY
PEM221010W	10	x 10	10	200
PEM221515W	15	x 15	10	80
PEM222222W	22	x 22	5	30

Suitable for central heating systems

Please note a Collet Cover cannot be used on a Speedfit end assembled with the stem of a 22mm Stem Elbow.

EQUAL TEE



PART No.	SIZE MM	BAG QTY	Box QTY
PEM0210W	10	10	100
PEM0215W	15	5	140
PEM0222W	22	5	15
PEM0228W	28		10

Suitable for central heating systems.

REDUCING TEE



Sizes are listed in the following order.

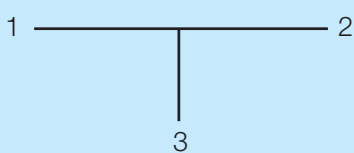

PART No.	SIZE MM	BAG QTY	Box QTY
PEM3015BW	15 x 10 x 10	10	60
PEM3015AW	15 x 15 x 10	5	40
PEM3022CW	15 x 15 x 22	5	25
PEM3022BW	22 x 15 x 15	5	25
PEM3022DW	22 x 15 x 22	5	15
PEM302210AW	22 x 22 x 10	5	20
PEM3022AW	22 x 22 x 15	5	15
PEM3028BW	28 x 22 x 22		10
PEM3028AW	28 x 28 x 22		10
PEM3028DW	28 x 22 x 28		10

Suitable for central heating systems.

STEM TEE



Sizes are listed in the following order.

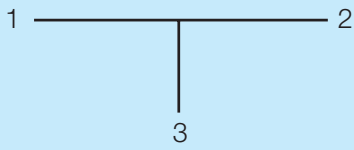

PART No.	SIZE MM	BAG QTY	BOX QTY
PEM532210W	22 x 22 x 10	5	30
PEM532215W	22 x 22 x 15	5	25

Suitable for central heating systems.

FEMALE COUPLER - TAP CONNECTOR



Requires hand tightening only.

PART No.	SIZE MM X BSP	BAG QTY	BOX QTY
PKM3210W	10 x 1/2"	10	150
PKM3201W	15 x 1/2"	10	100
PKM3203W	15 x 3/4"	10	100
PKM3202W	22 x 3/4"	5	50

Suitable for central heating systems

Note: Plastic threads are not as strong as metal threads.

For torque figures see Technical Checklist.

STRAIGHT TAP CONNECTOR

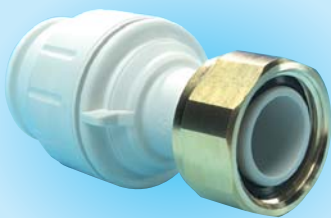

With brass swivel nut and sealing washer.

PART No.	SIZE MM X BSP	BAG QTY	BOX QTY
PEMSTC1514	15 x 1/2"	5	50
PEMSTC1516	15 x 3/4"	5	50
PEMSTC2216	22 x 3/4"	5	40

Suitable for central heating systems.

For torque figures see Technical Checklist.

BENT TAP CONNECTOR



With brass swivel nut and sealing washer.

PART No.	SIZE MM X BSP	BAG QTY	BOX QTY
PEMBTC1514	15 x 1/2"	5	50

Suitable for central heating systems.

For torque figures see Technical Checklist.

TANK CONNECTOR



Requires hand tightening only.
Maximum wall thickness of tank 4mm.

PART No.	SIZE MM	BAG QTY	BOX QTY
CM0715S	15	10	60
CM0722S	22	5	20
CM0728S	28		10

Suitable for cold water tanks only.

STOP END



PART No.	SIZE MM	BAG QTY	BOX QTY
PSE4610W	10	10	300
PSE4615W	15	10	200
PSE4622W	22	5	100

Suitable for central heating systems.

REDUCER



PART No.	SIZE MM	BAG QTY	BOX QTY
PEM061510W	15 x 10	10	150
PEM062215W	22 x 15	10	70
PEM062815W	28 x 15	5	40
PEM062822W	28 x 22	5	30

Suitable for central heating systems.

PLUG



PART No.	SIZE MM	BAG QTY	BOX QTY
PL10	10	10	500
PL15	15	10	250
PL22	22	5	100
PL28	28		

Suitable for central heating systems.

CONVERSION CONNECTOR



Connects imperial to metric pipe.

PART No.	SIZE	BAG QTY	BOX QTY
NC471	1/2 id x 15mm	5	500
NC2324	3/4 id x 22mm		30

Suitable for central heating systems.

SLIP CONNECTOR



PART No.	SIZE MM	BAG QTY	BOX QTY
CM-SC-15S	15	10	100

Not suitable for central heating systems.

Hot and Cold water only, 65°C maximum.

HOSE CONNECTOR



PART No.	SIZE	BOX QTY
NC448	15mm x 1/2"	1000
NC473	22mm x 3/4"	400
NC737	22mm x 1/2"	500

Not suitable for central heating systems.

Hot and Cold water only, 65°C maximum.

RADIATOR PLATE



Creates a neat outlet for 10mm supply pipes to a radiator. To be used with single gang 25mm steel K0 boxes to BS 4662, fitted with rubber grommet.

PART No.	BAG QTY	BOX QTY
JG- ROP	1	50



MANIFOLDS

4 WAY MANIFOLD

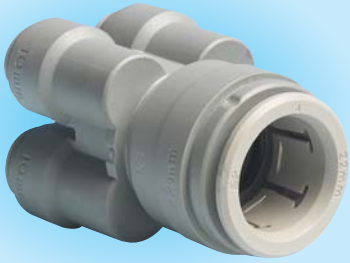

PART No.	SIZE MM	BAG QTY	Box QTY
SFM512210S	22 x 10	5	40

Suitable for central heating systems.

4 PORT RAIL MANIFOLD



PART No.	SIZE MM	Box QTY
SFM522210S	22 x 10	5
SFM522215S	22 x 15	5

Suitable for central heating systems.

BRASS RAIL MANIFOLD

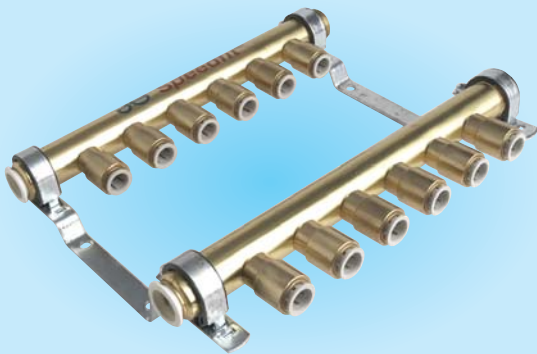

PART No.		SIZE MM	Box QTY
JGRAIL4	4 ZONE	22 x 15	1
JGRAIL6	6 ZONE	22 x 15	1
JGRAIL12	12 ZONE	22 x 15	1

BRASS MANIFOLD



	PART No.		SIZE	Box QTY
Red Handle	JGMAN2-R	2 PORT	3/4" x 15	1
	JGMAN3-R	3 PORT	3/4" x 15	1
	JGMAN4-R	4 PORT	3/4" x 15	1
Blue Handle	JGMAN2-B	2 PORT	3/4" x 15	1
	JGMAN3-B	3 PORT	3/4" x 15	1
	JGMAN4-B	4 PORT	3/4" x 15	1

Blanking plug supplied with each manifold.

BRASS FITTINGS

BRASS MALE COUPLER

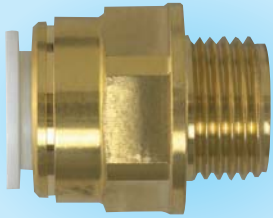

PART No.	SIZE MM X BSPT	BAG QTY	BOX QTY
----------	-------------------	------------	------------

MW011504N	15 x 1/2"	5	100
MW012206N	22 x 3/4"	5	50
MW012808N	28 x 1"	5	20

PART No.	SIZE MM X BSP	BAG QTY	BOX QTY
----------	------------------	------------	------------

10MC (1/2)	10 x 1/2"	5	100
15MC (1/2)	15 x 1/2"	5	100
22MC (3/4)	22 x 3/4"	5	50
MW012818N	28 x 1"	5	20

Suitable for central heating systems.

Manufactured in DZR Brass.

BRASS WINGBACK ELBOW



PART No.	SIZE MM X BSP	BAG QTY	BOX QTY
----------	------------------	------------	------------

15WB	15 x 1/2"		20
22WB	22 x 3/4"		10

Suitable for central heating systems.

Manufactured in DZR Brass.

BRASS MALE STEM ADAPTOR

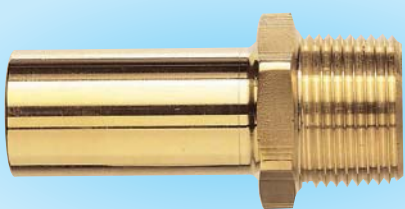

Converts Speedfit to male thread.

PART No.	SIZE MM X BSPT	BAG QTY	BOX QTY
----------	-------------------	------------	------------

MW051504N	15 x 1/2"	5	100
MW052206N	22 x 3/4"	5	50
MW052818N	28 x 1" BSP	10	20

Suitable for central heating systems.

Manufactured in DZR Brass.

BRASS FEMALE STEM ADAPTOR

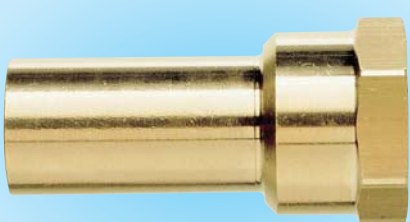

Converts Speedfit to female thread.

PART No.	SIZE MM X BSP	BAG QTY	BOX QTY
----------	------------------	------------	------------

MW501514N	15 x 1/2"	5	50
MW502216N	22 x 3/4"	5	50

Suitable for central heating systems.

Manufactured in DZR Brass.

BRASS MALE CYLINDER ADAPTOR

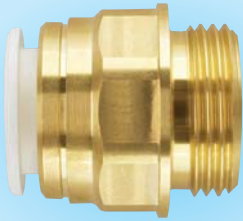

PART No.	SIZE MM X BSP	BAG QTY	BOX QTY
22CMA	22 x 1"	1	50

Suitable for central heating systems.

Manufactured in DZR Brass.

BRASS FEMALE CYLINDER ADAPTOR



PART No.	SIZE MM X BSP	BAG QTY	BOX QTY
22CFA	22 x 1"	1	50

Suitable for central heating systems.

Manufactured in DZR Brass.

IRISH ADAPTORS

IRISH PIPE SIZE ADAPTOR

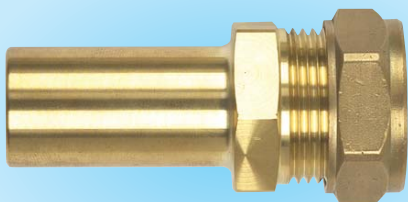

PART No.	SIZE MM X IRISH	BAG QTY	BOX QTY
NC2238	15 x 1/2"	5	50
NC2239	22 x 3/4"	5	30

Suitable for central heating systems.

STRAIGHT CONNECTOR METRIC x IRISH SIZE



PART No.	SIZE MM X IRISH	BAG QTY	BOX QTY
PEMIR15	15 x 1/2"	10	60
PEMIR22	22 x 3/4"		

Suitable for central heating systems.

FLEXI HOSES

SPEEDFIT X UNION NUT

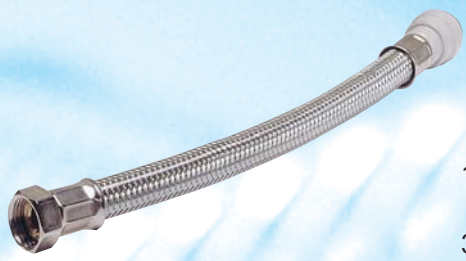

150mm long

300mm long

500mm long

1000mm long



300mm long



PART No.	SIZE MM X BSP	BAG QTY	BOX QTY
FLX43	15 x 1/2"	25	200
FLX34	10 x 1/2"	25	150
FLX35	15 x 3/8"	25	200
FLX15	15 x 1/2"	25	100
FLX16	15 x 3/4"	25	100
FLX22	22 x 3/4"	25	100
FLX18	15 x 1/2"	20	100
FLX20	15 x 3/4"	20	100
FLX19	22 x 3/4"	10	50
FLX23 Full Bore	22 x 3/4"	5	40
FLX40	15 x 1/2"	5	25
FLX42	15 x 3/4"	5	25
FLX41	22 x 3/4"	5	25
PVC HOSE			
WFLX15	15 x 1/2"	25	100
WFLX16	15 x 3/4"	25	100
WFLX22	22 x 3/4"	25	100

SPEEDFIT X SPEEDFIT

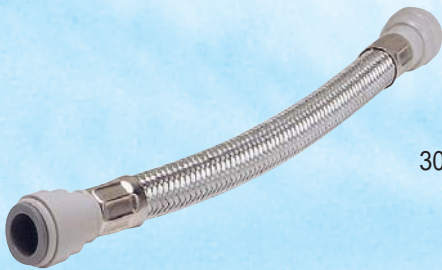

300mm long

500mm long

500mm long

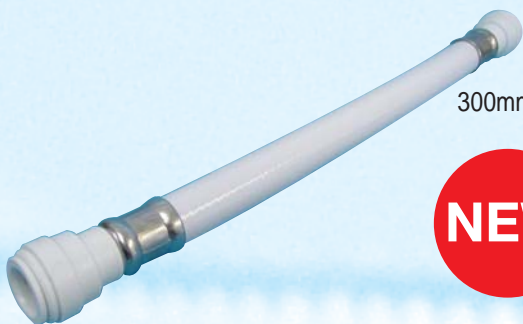

300mm long



PART No.	SIZE MM	BOX QTY	BAG QTY
FLX33	15 x 10	25	200
FLX17	15 x 15	25	100
FLX26	22 x 22	20	60
FLX21	15 x 15	20	100
FLX27	22 x 22	10	60
FLX47	15 x 15	5	25
PVC HOSE			
WFLX17	15 x 15	25	100

SPEEDFIT X MALE THREAD

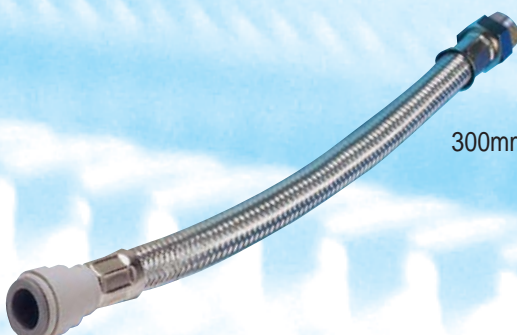

300mm long

PART No.	SIZE MM X BSP	BOX QTY	BAG QTY
FLX49	15 x 1/2"	20	100

SPEEDFIT X UNION NUT WITH SERVICE VALVE

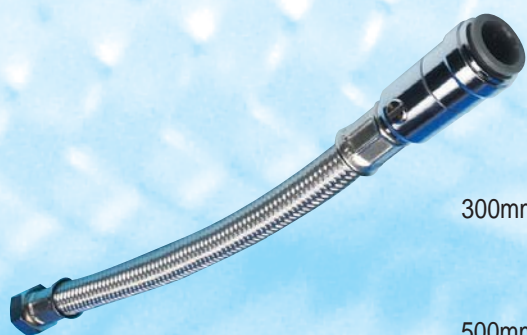

300mm long

500mm long

300mm long

PART No.	SIZE MM X BSP	BAG QTY	BOX QTY
----------	------------------	------------	------------

Brass Valve

FLX24	15 x 1/2"	20	80
--------------	------------------	-----------	-----------

FLX25 Full Bore	22 x 3/4"	5	25
------------------------	------------------	----------	-----------

FLX31	15 x 1/2"	10	50
--------------	------------------	-----------	-----------

FLX38	15 x 3/4"	10	50
--------------	------------------	-----------	-----------

FLX32 Full Bore	22 x 3/4"	5	25
------------------------	------------------	----------	-----------

Plastic Valve

FLX37	15 x 1/2"	25	100
--------------	------------------	-----------	------------

FLX39	22 x 3/4"	TBA	TBA
--------------	------------------	------------	------------

Plastic Valve with Handle

FLX37-H	15 x 1/2"	25	100
----------------	------------------	-----------	------------

SPEEDFIT X SPEEDFIT WITH SERVICE VALVE



300mm long

500mm long

PART NO.	SIZE MM	BAG QTY	BOX QTY
----------	------------	------------	------------

Brass Valve

FLX44	15 x 15	20	80
--------------	----------------	-----------	-----------

FLX45	15 x 15	10	60
--------------	----------------	-----------	-----------

FOR MONOBLOC MIXERS

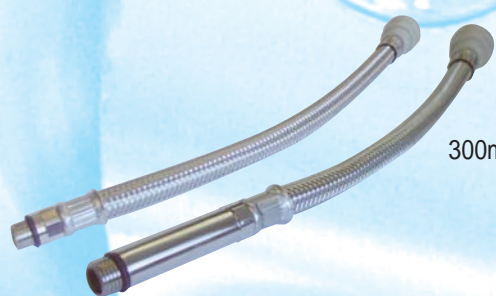

300mm long

PART No.	SIZE MM X MALE	BAG QTY	BOX QTY
----------	-------------------	------------	------------

FLX48	12 x M10	1 Pair	TBA
--------------	-----------------	---------------	------------

FLX28	15 x M10	1 Pair	50 Pairs
--------------	-----------------	---------------	-----------------

FLX29	15 x M12	1 Pair	50 Pairs
--------------	-----------------	---------------	-----------------

ELBOW PATTERN

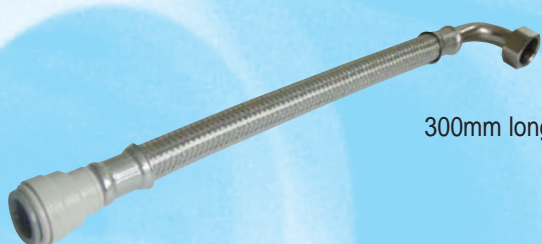

300mm long

PART No.	SIZE MM X BSP	BAG QTY	BOX QTY
----------	------------------	------------	------------

FLX36	15 x 1/2"	25	100
--------------	------------------	-----------	------------

**Not suitable for central heating systems.
Hot and Cold water only, 65°C max.**

VALVES

STOP VALVE



PART No.	SIZE MM	Box QTY
15STV	15	20
22STV	22	10

Not suitable for central heating systems.

Hot and Cold water only, 65°C maximum.

BRASS STOP VALVE



PART No.	SIZE MM	Box QTY
15BSC	15	10

Body and Head DZR Brass.

WASHING MACHINE TAP



PART No.	SIZE MM X BSP	Box QTY
15 APT	15 x 3/4"	20

Not suitable for central heating systems.

Hot and Cold water only, 65°C maximum.

For torque figures on plastic threads please see Technical Checklist.

EMERGENCY SHUT OFF TAP



PART No.	SIZE MM X BSP	Box QTY
15 ESOT	15	20

Not suitable for central heating systems.

Hot and Cold water only, 65°C maximum.

BRASS DRAIN COCK

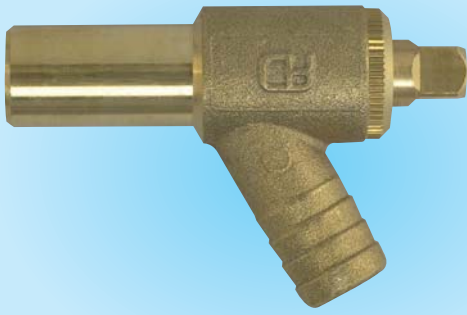

PART No.	SIZE MM	BOX QTY
15BDC	15	50

Suitable for central heating systems.

Manufactured in DZR Brass.

Please note a collet cover cannot be used on a Speedfit end assembled with a draincock.

Draincocks can be fitted with a standard fitting fitted with a collet clip. When using with Twist and Lock Fittings the fitting must be locked.

DOUBLE CHECK VALVE

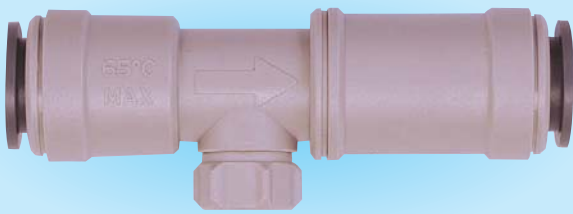

PART No.	SIZE MM	BAG QTY	BOX QTY
15DCV	15	5	50

Not suitable for central heating systems.

Hot and Cold water only, 65°C maximum.

PLASTIC SERVICE VALVE



PART No.	SIZE MM	BAG QTY	BOX QTY
15ISV	15	5	50
15SV*	15		

Not suitable for central heating systems.

Hot and Cold water only, 65°C maximum.

* New design available 3rd quarter of 2005.

BRASS CHROME PLATED BALL VALVE



PART No.	SIZE MM	BAG QTY	BOX QTY
10BV	10	1	30
15BV	15	2	20
22BV	22	1	8

Suitable for central heating systems.

Each Valve has a red and a blue indice.

VALVES

BRASS SERVICE VALVE



PART No.	SIZE MM	BAG QTY	BOX QTY
15HSV-BRASS	15	2	20

Suitable for central heating systems.

BRASS CHROME PLATED SERVICE VALVE



Mechanism twists out of sight,
to discourage tampering.



PART No.	SIZE MM	BAG QTY	BOX QTY
10HSV	10	1	30
15HSV	15	2	20
22HSV	22	1	8

Suitable for central heating systems.

BRASS CHROME PLATED SERVICE VALVE WITH TAP CONNECTOR

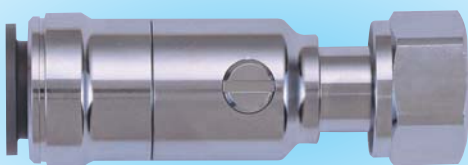

PART No.	SIZE MM X BSP	BAG QTY	BOX QTY
15PTSV	15 x 1/2"	2	20
22PTSV	22 x 3/4"	1	8

Suitable for central heating systems.

PIPE AND PIPE ACCESSORIES

PEX BARRIER PIPE



Coils

The pipe has an inner barrier to stop the ingress of atmosphere.

British Gas accepted for water pipe in vented and sealed central heating systems.

PART No.	SIZE MM X M	PACK QTY	BOX QTY
10BPEX-25C	10 x 25	1	20
10BPEX-50C	10 x 50	1	10
10BPEX-100C	10 x 100	1	6
15BPEX-25C	15 x 25	1	8
15BPEX-50C	15 x 50	1	5
15BPEX-100C	15 x 100	1	5
15BPEX-120C	15 x 120	1	5
15BPEX-150C	15 x 150	1	4
22BPEX-25C	22 x 25	1	8
22BPEX-50C	22 x 50	1	5

Suitable for central heating systems.

PEX BARRIER PIPE



Straight lengths

The pipe has an inner barrier to stop the ingress of atmosphere.

*By special order only.

PART No.	SIZE MM X M	PACK QTY
15BPEX-20x2L	15 x 2	20
15BPEX-20x3L	15 x 3	20
15BPEX-20x6L	15 x 6	20
22BPEX-20x2L	22 x 2	20
22BPEX-20x3L	22 x 3	20
22BPEX-20x6L	22 x 6	20
28BPEX-10x3L	28 x 3	10
* 28BPEX-10x6L	28 x 6	10

Suitable for central heating systems.

POLYBUTYLENE BARRIER PIPE



Coils

The pipe has an inner barrier to stop the ingress of atmosphere.

British Gas accepted for water pipe in vented and sealed central heating systems.

PART No.	SIZE MM X M	PACK QTY
15BPB-50C	15 x 50	1
15BPB-100C	15 x 100	1
15BPB-120C	15 x 120	1
15BPB-150C	15 x 150	1
22BPB-50C	22 x 50	1

PIPE AND PIPE ACCESSORIES

SUPERSEAL PIPE INSERT

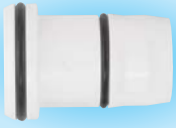

To be used only with Speedfit Pipe and Speedfit Fittings to enhance the sealing security of the connections, see page 16.

PART No.	SIZE MM	BAG QTY	BOX QTY
STS10	10	50	1000
STS15	15	50	500
STS22	22	25	250
STS28	28	10	150

Suitable for central heating systems.

PIPE INSERT



To be used when connecting Speedfit Pipe to a compression fitting. See Page 35.

PART No.	SIZE MM	BAG QTY	BOX QTY
TSM10N	10	50	1000
TSM15N	15	50	500
TSM22N	22	25	250
TSM28N	28	10	150

Suitable for central heating systems.

CONDUIT PIPE



To be used when Speedfit Pipe is laid in Concrete and Masonry, see section on page 44.

PART No.	SIZE MM X M	PACK QTY
15BLK CON-25C	15 x 25	1
15BLK CON-50C	15 x 50	1
22BLK CON-25C	22 x 25	1
22BLK CON-50C	22 x 50	1

CONDUIT ELBOW



PART No.	SIZE MM	BAG QTY	BOX QTY
CONELB	FITS 10, 15 & 22mm	10	70

COLLET COVER



Available in white, red or blue

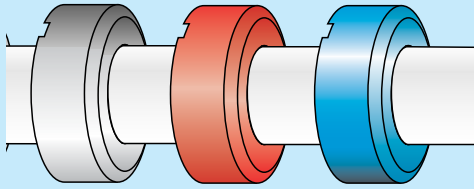

PART No.	SIZE MM	BAG QTY
PKM1910W	10	100
PKM1910R	10	100
PKM1910B	10	100
AM1915W	15	100
PM1915R	15	100
PM1915B	15	100
AM1922W	22	50
PM1922R	22	50
PM1922B	22	50

Suitable for central heating systems

COLLET LOCKING CLIP



Grey



White



Red



Blue

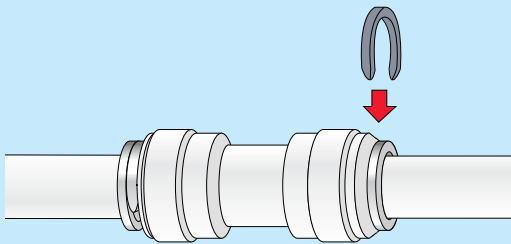

PART No.	SIZE MM	BAG QTY
CM1810S	10	100
CM1815S	15	100
CM1822S	22	100
CM1810W	10	100
CM1815W	15	100
CM1822W	22	100
CM1810R	10	100
CM1815R	15	100
CM1822R	22	100
CM1810B	10	100
CM1815B	15	100
CM1822B	22	100

Suitable for central heating systems.

White and grey collet clips prevent accidental release of pipe from standard fittings.

Red and blue clips provide colour coding of pipe, they should not be used to prevent accidental release of pipe.

RELEASE AID



PART No.	SIZE MM	BAG QTY	BOX QTY
10RA	10	10	500
15RA	15	10	500
22RA	22	10	400

PIPE AND PIPE ACCESSORIES

COLD FORMING BEND



PART No.	SIZE MM	BAG QTY	BOX QTY
10CFB	10	10	200
15CFB	15	10	30
22CFB	22	10	10

To help create a tighter bend than the minimum with unsupported pipe.

BENDING SPRINGS

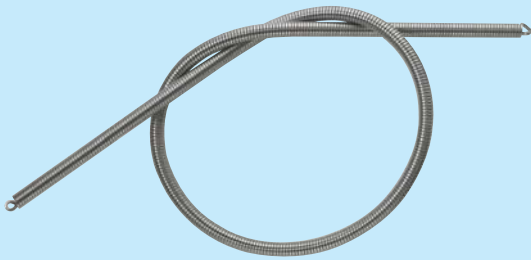

PART No.	SIZE MM	PACK QTY
JG-BS10	10	5
JG-BS15	15	5
JG-BS22	22	5

PIPE CUTTER



For up to 22mm size pipe.

PART No.	PACK QTY
JG-TS	1

HEAVY DUTY PIPE CUTTER



For up to 28mm size pipe.

PART No.	PACK QTY
JG HDC	1
BLADE-JGHDC	1

PIPE CLIPS AND SPACERS



PART No.	SIZE MM	PACK QTY	BOX QTY
PC15W	15	50	200
PC22W	22	50	100
PC28W	28	20	80
PCSW		50	400

NAIL CLIP



PART No.	SIZE MM	PACK QTY	BOX QTY
NPC10	10	50	1000
NPC15	15	50	400
NPC22	22	50	250
NPC28	28	50	200

PLUMBING SPARE PARTS

BAND CUTTER



PART No.	PACK QTY
JGBANDCUTTER	10

COLLETS



For PKM Fittings

PART No.	SIZE MM	PACK QTY
PXC 10	10	20
PXC 15	15	20
SPF 22	22	20
PXC 28	28	

For Twist and Locks Fittings

PXC 10	10	20
PXC 15	15	20
PXC 22	22	20
PXC 28	28	

EPDM 'O' RING



PART No.	SIZE MM	PACK QTY
10 EPR	10	20
15 EPR	15	20
22 EPR	22	20
28 EPR	28	20

THREAD WASHER



PART No.	SIZE	PACK QTY
1/2 EPW	1/2	20
3/4 EPW	3/4	20

For use with Female Coupler/Tap Connector.

SYSTEM CONNECTIONS

CONNECTION TO COMPRESSION FITTING

Many but not all compression fittings are suitable for use with plastic fittings and pipe. Users should therefore check for compatibility. Compression fittings with short tube stop depth or hard olives should not be used with plastic fittings or pipe.

When using compression fittings with Speedfit pipe, a Standard Pipe Insert (prefix TSM) must be used to withstand the compressive pressure of the olive. The olive must be located within the length of the pipe insert and the pipe fully inserted into the fitting. The connection should not need more than 2 full turns after the olive has gripped the pipe. Copper olives are preferable to brass olives.

Ensure nut and olive are in place before inserting pipe insert.

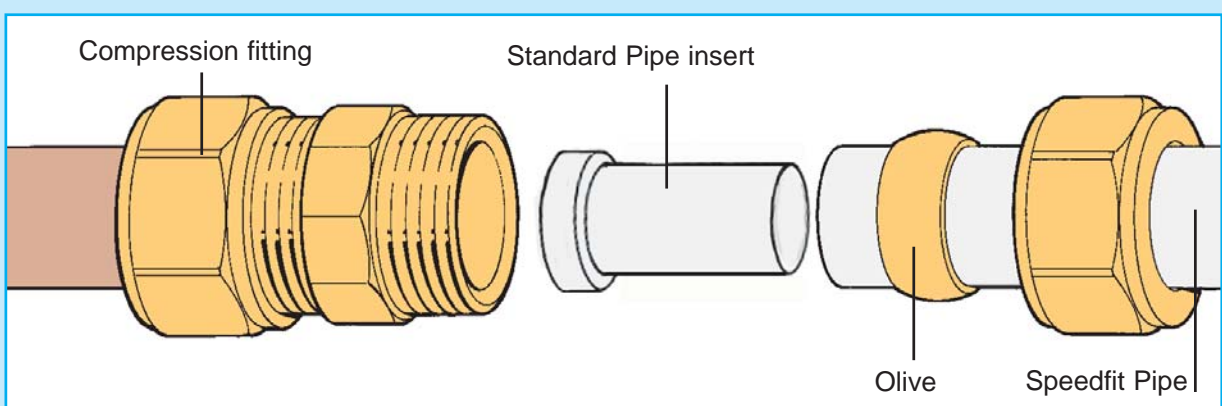

CONNECTION TO IMPERIAL PIPE AND FITTINGS

The Speedfit Range includes couplers to connect Speedfit Pipe to 1/2" to 1" BSP and BSPT. See page 23.



Fittings to connect imperial pipe to metric are shown on page 21.

CONNECTION TO CHROME-PLATED COPPER PIPE

Speedfit fittings can be connected onto chromium plated copper pipe if the chromium plating is completely removed to the full depth of the fitting. To ensure maximum grip, the fitting of a collet clip is recommended.

It is not possible to connect Speedfit fittings to Stainless Steel Pipe.

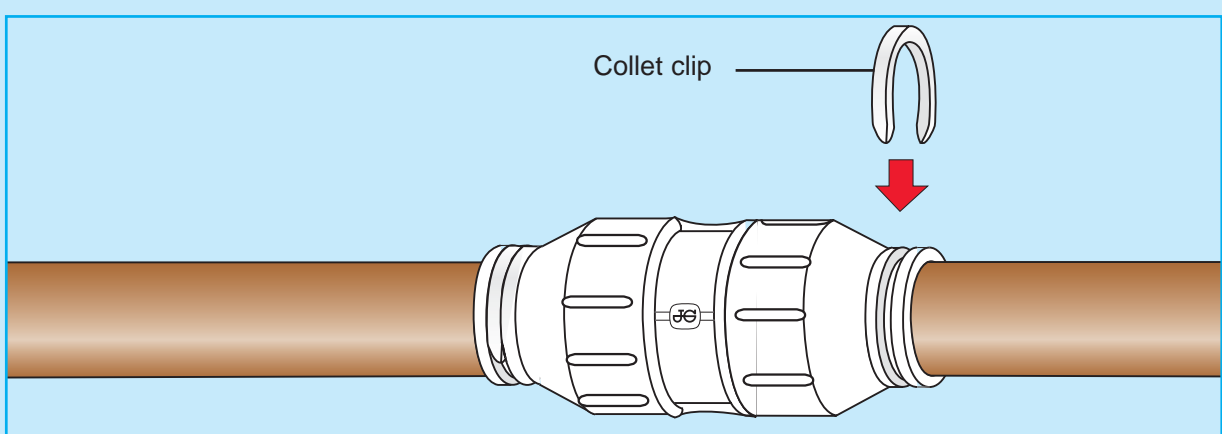

CONNECTION TO MAINS SUPPLY

In modern properties, water enters a building usually in blue MDPE (medium density polyethylene) pipe. In order to comply with Water Regulation Schedule 2.10, the internal plumbing system should be connected via a Speedfit Stop Valve (Part Nos. 15STV and 22STV) in conjunction with a PE-Copper Coupler from the Speedfit range of Underground Fittings.

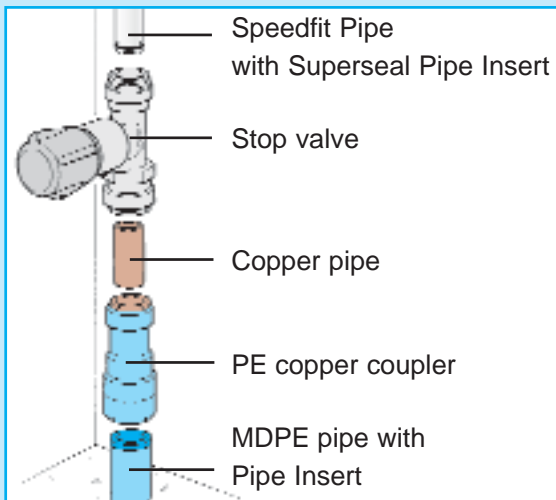

Connection of Speedfit pipe to supply pipe of other materials should be via a stop tap with a 15mm or 22mm compression outlet.

CONNECTIONS TO RING MAINS

Water-replenishing ring mains are typically used in hotels and hospitals. They are maintained at a constant high temperature to supply hot water to distribution pipes to wards or hotel rooms which may be some way from the heat source.

These systems are very different from more conventional domestic hot water and central heating systems.

Speedfit Products cannot be used on ring main systems. The exception would be those systems designed for domestic situations which have an intermittent temperature of less than a maximum of 65°C. This is in accordance with BS7291 Parts 1 and 3 Class S.

CONNECTION TO BOILERS

Speedfit pipe should never be connected directly to a boiler.

Although most modern boilers have a high limit thermostat, residual heat can be conducted by the heat exchanger. Therefore, Speedfit recommend a minimum of 1 metre from the boiler casing should be run in copper pipe unless otherwise stated in the boiler manufacturers installation literature.

A gravity primary circuit operating on an uncontrolled cooking range or solid fuel boiler should be run entirely in copper and the heating circuit run in copper for the first metre.

Refer to BS 5955: Part 8 for further clarification.

All appliances should have safety devices to make sure they cannot operate above the working temperature and pressure range set out in our Technical Checklist on page 58. If safety devices are not incorporated within the appliance then external controls will be needed.

Speedfit Products should not be fitted to a back fired boiler or other uncontrolled heat source.

Please also see **Drop-Pipe Systems on page 37** and **System Commissioning and Flushing on page 48**.

CONNECTING TO OTHER PLUMBING FIXTURES

As shown in the Product Range List, the Speedfit range of fittings includes valves, taps, adaptors and connectors for the plumbing of all typical domestic appliances and fittings.

CONNECTION TO CYLINDERS & WATER HEATERS

Speedfit can be used on sealed and open vented heating systems, where boilers are either heating a hot water storage cylinder or instantaneous hot water such as a combination boiler. The temperature and pressure limits of the system must not exceed the maximum values stated under the heading 'Working Temperatures and Pressures'.

When using a traditional copper vented cylinder Speedfit pipe and fittings can be installed with direct connections to the cylinder.

Unvented pressurised cylinders can be installed using Speedfit pipe and fittings. However, insertion depths on compression joints that form part of the cylinder must be checked prior to installation and the use of standard pipe inserts (Prefix TSM) is recommended.

In accordance with current U.K. Building Regulations (Part G), discharge pipes from temperature and/or pressure relief valves must be run in metal pipework.

Speedfit connections to combined Cylinder/Boiler units and Thermal Storage Units must be made outside the casing unless otherwise stated in manufacturers installation literature.

DROP-PIPE SYSTEMS

Care should be taken when designing and installing a central heating system where radiators are supplied by pipe work which drops from an upper floor.

With this kind of system it is possible to trap air in the upper floor pipe work. When the boiler is fired the increase in pressure within the pipe caused by expanding air could cause the pipe to burst.

It is therefore essential that the system be designed so that any air can be removed from the system either automatically or manually by installing automatic or manual air vents at the highest points of the system.

DISCHARGE PIPES

Speedfit pipe should not be used to provide the discharge from unvented cylinders, unvented water heaters and sealed systems via the temperature relief and pressure relief valves.

WATER HEATERS

Speedfit recommend that mains supply pipework to unvented water heaters (up to 15ltr capacity), be run in metal pipes.

CONNECTION TO PUMPS AND VALVES

Speedfit pipe should be connected to circulating pumps, motorised valves in accordance with the section in this book headed, “Connecting Plastic Pipe To Compression Fittings”. If Speedfit pipe is not mounted on a supporting structure, the pipe must be clipped close to the components’ connections to ensure adequate support and to assist in the reduction of vibration.

For heavier equipment, ensure that appropriate metal brackets provide full and independent support of the components and that it does not rely solely on the pipework for support.

CONNECTION TO COPPER PIPE

The minimum distance to make a solder connection on copper pipe inserted into a Speedfit Fitting is 450mm (18 inches). Ensure that any residual flux solder is not allowed to come in contact with the fitting. That same measurement is the safe distance to use a freezer kit to Speedfit Pipe.

CONNECTING TO COLD WATER STORAGE TANK

To install the Speedfit Tank Connector, unscrew the nut and push the body of the fitting through the tank hole with the washer on the inside of the tank.

Hand tighten the nut onto the body. Push the pipe into the connector.

Note: Hand tightening the nut onto the body is all that is required. Further mechanical tightening will damage the fitting.

Maximum wall thickness of tank 4mm

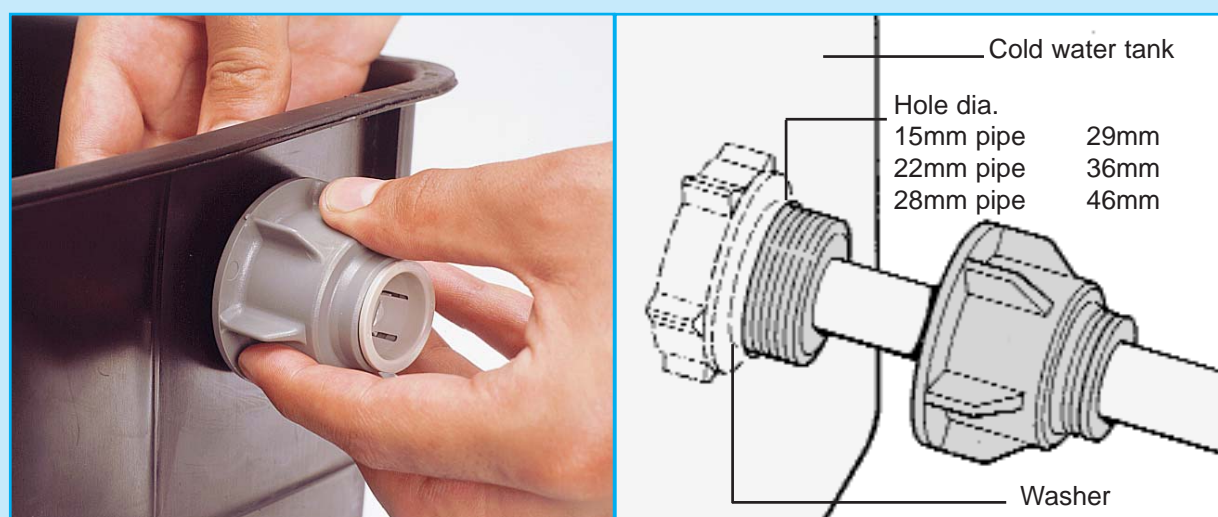

PREVENTING BACK FLOW

The Speedfit range includes a Double Check Valve (Part No 15DCV) to enable installers to comply with Water Regulation

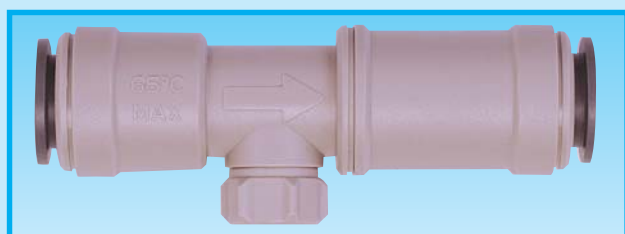

Schedule 2.15, thus preventing contamination of water arising from back siphonage, backflow or cross connection.

RADIATOR CONNECTIONS

The most common way of running pipework to a radiator is to run both flow and return pipes central to the radiator position.



The pipes exit a single gang box (fitted with rubber grommets) located at the mid height of the finished radiator position. This also provides a fixed point for other trades to work to and reduces the risk of damage to the pipework.

Once the plasterboard is installed the pipes are passed through the Speedfit Radiator Outlet Plate to exit plasterboard without the need of unsightly holes.

ELECTRICAL CONTINUITY

The plumbing or heating system installer should have these aspects checked to ensure compliance with current IEE regulations. If in doubt please contact the Speedfit Technical Advisory Service or consult your local Electricity Authority.

IEE Guidance Note 7 provides useful guidance on the design of electrical installations where there is increased risk of electric shock. It recognises that the requirement for supplementary bonding may be relaxed where metal taps and plastic pipes supply other bathroom fittings.

Similarly a metal bath or radiator not connected to an extraneous-conductive-part is not required to be connected to the local supplementary conductors.

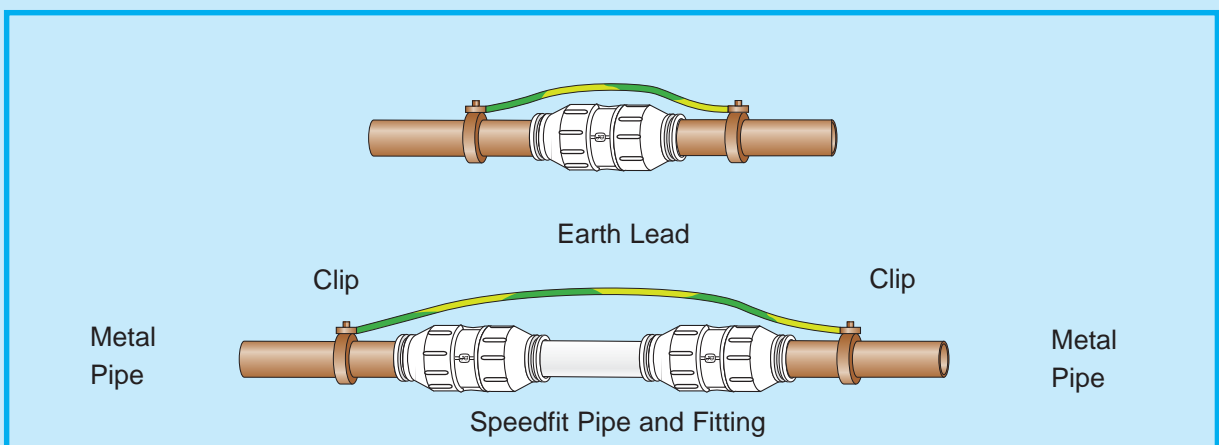

SUPPLEMENTRY BONDING TO BATHROOMS

Pipe Material			Supplementary Bond Required Between	Comments
Cold Water	Hot Water	Central Heating		
P	P	P	Earth terminals of protective conductors of class I and of class II equipment and accessible exposed conductive parts of the building structure.	Bonding of metal taps metal radiators or metal baths is not required unless the bath is connected to the metallic building structure.
P	M	M	Hot water pipe, central heating pipes, earth terminals of protective conductors of class I and class II equipment and accessible exposed conductive parts of the building structure.	A bond is not required to the taps either hot nor cold, or to metal baths unless connected to the metallic building structure.
P	P	M	Central heating pipes, the earth terminals of protective conductors of class I and class II equipment and access to exposed conductive parts of the building structure.	Bonding of metal water taps is not required, nor metal baths unless connected to the metallic building structure.
M	M	M	All metal pipes, earth terminals of protective conductors class I and class II equipment, and accessible exposed conductive parts of the building structure.	Metal pipes themselves can be used as bonding conductors if joints are metal to metal and electrically continuous.
M	M	P	All metal pipes, earth terminals of protective conductors of class I and class II equipment, and accessible exposed conductive parts of the building structure.	Metal central heating radiator does not require bonding.

P = Plastic M = Metal NB: All Waste Pipes are plastic.

1. Supplementary bonding is carried out to the earth terminal of protective conductors of class I and class II equipment within the bathroom. A supplementary bond is not run back to the main earth.
2. Metal window frames are not required to be supplementary bonded unless they are electrically connected to the metallic structure of the bonding.
3. Metal baths supplied by metal pipes do not require supplementary bonding if all the pipes are bonded and there is no other connection of the bath to earth.
4. All bonding connections must be accessible and labelled "Safety Electrical Connection - Do Not Remove".

INSTALLING PIPEWORK

SPEEDFIT BARRIER PIPE

Speedfit Barrier Pipe is manufactured to BS 7291 Parts 1, 2 and 3 Class S and is Kitemarked.

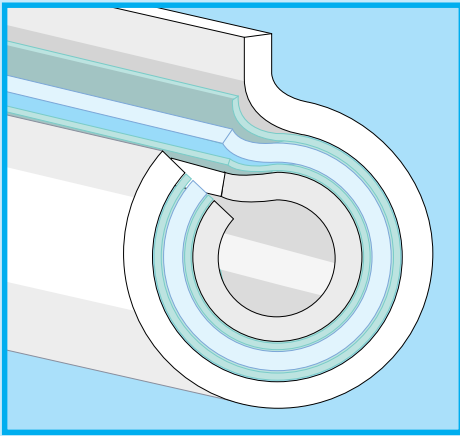

It is made up of 5 layers, the centre of which is a blue coloured oxygen barrier which prevents the ingress of air into the system, thereby reducing the effect of corrosion on metal components.

Because of its low thermal conductivity, when carrying hot water, Speedfit Pipe is cooler and therefore safer to touch. Relatively low heat loss through radiation means that a system retains its heat longer and delivers hot water more quickly and with less wastage than a metal system.

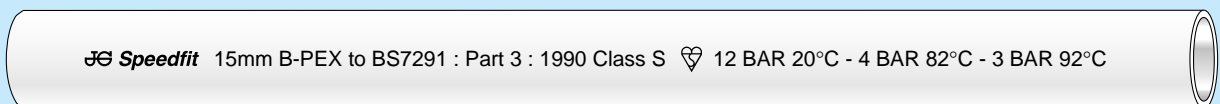

The pipe is available in coils and straight lengths. See pages 28. Pipe markings are spaced to aid the making of a good connection when using a Superseal Pipe Insert.

PIPEWORK SIZING

For general guidance on pipework sizing, please refer to BS6700 or the Institute of Plumbing Engineering Services Design Guide. Speedfit fittings are suitable for pipes within $\pm 0.1\text{mm}$ of nominal size. They can be used with copper pipe to BS EN 1057 or Speedfit plastic pipe.

The Product Range List shows the fittings available for reducing pipe diameters within the system.

Speedfit pipe is available in straight lengths and coils.

	<i>Pipe Diameter</i>				
Straights	2m	-	15mm	22mm	-
	3m	-	15mm	22mm	28mm
	6m	-	15mm	22mm	28mm
Coils	25m	10mm	15mm	22mm	-
	50m	10mm	15mm	22mm	-
	100m	10mm	15mm	-	-
	120m	-	15mm	-	-
	150m	-	15mm	-	-

PIPE BENDING

Gentle bends can be made with pipe clips on either side of the curve, positioned to maintain the bend radius.

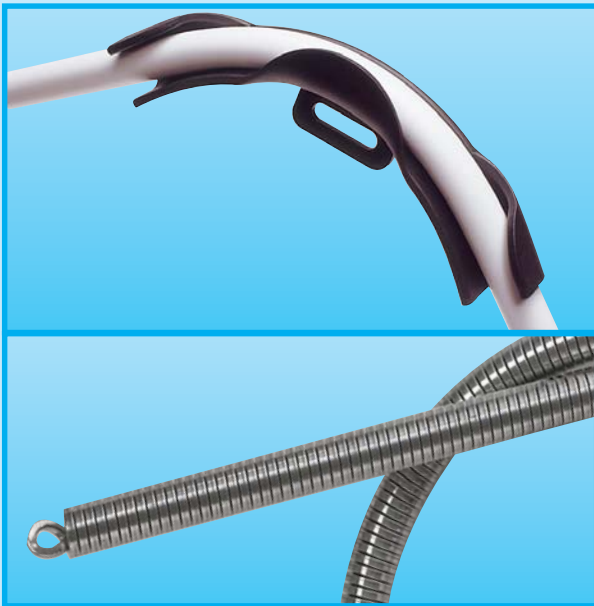

Tighter bends can be achieved by using the cold forming bends shown on page 33.

Internal Bending Springs are available in 10mm to 22mm sizes. See page 33.

It is also possible to bend Speedfit Pipe using a standard pipe bender. The pipe should not be heated with a blowlamp or hot air gun.

Minimum bend radii for Speedfit pipe are as follows:

	<i>Min Radius</i>				<i>Pipe Diameter</i>			
	10mm	15mm	22mm	28mm				
<i>with Cold Forming Bends</i>	30mm	75mm	110mm	-				
<i>with Clips</i>	100mm	175mm	225mm	300mm				

For bends of radii smaller than those shown, standard elbow fittings are recommended.

PIPE SUPPORT AND CLIPPING

There are two types of pipe clip in the Speedfit range.



Firstly, a nail clip is used for fixing to timber when running concealed pipe work i.e. underfloor or in a roof space. This clip takes less time to fit and is compact which allows pipework to be fixed close together when space is at a premium.



The second type uses a screw and therefore takes a little longer to fix. When pipes are required to cross over, it is possible to add a spacer to the clip. This will give room between the pipe and the wall to allow the pipes to cross over. If pipework needs to be insulated, using the spacer will give room for the lagging to be applied.

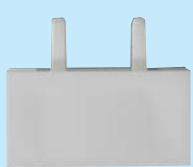

Pipe clips should not be fitted any closer than 60mm from the end of the fitting to allow for expansion. Pipes should always be adequately supported to prevent undue stress or side load on the fittings.

RECOMMENDED CLIP SPACING

For surface mounted pipes.

<i>Pipe Diameter</i>	<i>Clip Spacing</i>	
	<i>Horizontal Run</i>	<i>Vertical Run</i>
10 - 15mm	300mm	500mm
22mm	500mm	800mm
28mm	800mm	1,000mm

PIPE SIZING

For general guidance on pipework sizing, please refer to BS6700 and BS5449 or the Institute of Plumbing Engineering Services Design Guide. Speedfit fittings are suitable for connection to pipe sizes within ± 0.1 mm of nominal size.

The maximum heat carrying capacity and flow of Speedfit pipe, based on 1.2m/s velocity and an 11°C temperature drop is shown in the table below.

<i>Pipe size</i>	<i>Max Capacity</i> <i>KW</i>	<i>Max Flow</i> <i>litres/sec</i>	<i>Headloss</i> <i>m/m pipe</i>
10mm	1.948	0.042	0.283
15mm	5.941	0.129	0.139
22mm	13.604	0.295	0.084
28mm	21.991	0.478	0.062

PIPEWORK INSULATION

The insulation requirements for Speedfit pipe are the same as those for copper and should comply with BS6700 and BS5422.

CONCEALED PIPEWORK

The flexibility of Speedfit pipe gives it the ability to be threaded through concealed or inaccessible spaces without disruption to surrounding structures, making major savings in installation time.

Pipework can be “cabled” through drilled holes in joists and rafters. Therefore, pipework can be installed after floorboards have been laid, working below the floor before the ceiling is installed.

This makes site work far safer as the installer does not have to balance on open joists with the risk of dropping tools or equipment on other people below.

This will also eliminate the risk of damage by floorboard nails. There is no need for dry runs since pipe can be cut and connections made in-situ.

Rigid pipe, such as copper, can only be fed under floor in short lengths. However, Speedfit pipe, being flexible, can run from one fitting to another without having to install a connector in between.

Speedfit needs no jointing materials, eliminating the risk of fire from the use of a blowlamp, solder and flux.

TRADITIONAL JOISTS

Instructions on the drilling of joists is given in the Building Regulations Approved Document A, and summarised as follows:

1. Holes should be no greater than 0.25 of the depth of the joist.
2. Holes should be drilled at the neutral axis.
3. Holes should not be less than 3 diameters (centre to centre) apart.
4. Holes should be located between 0.25 and 0.4 times the span from the support.

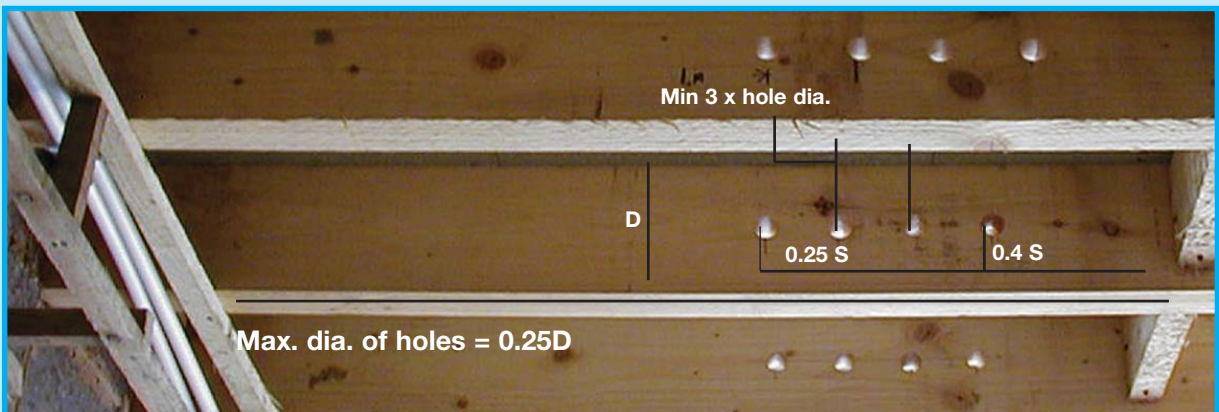

TIMBER I BEAM JOISTS

Several types of joists are available and Speedfit recommends that specific manufacturers details are consulted. However, the following can be used for general guidance.

- Holes may be located vertically anywhere in the web, but leave 3mm web at the top and/or bottom of hole. Do not cut into joist flanges when cutting the web.
- If more than one hole is to be cut in the web, the distance between the edges of the holes must be at least 2x diameter of the largest hole.
- Generally joists are manufactured with 38mm perforated knockouts in the web at approximately 300mm centres along the length of the joist.

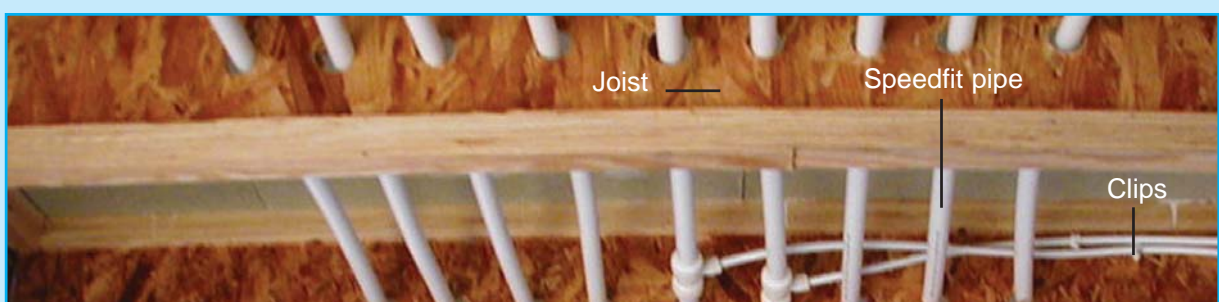

CROSS WEB JOISTS

Unlike I beam joists, pipe can be cabled anywhere within the open Web as no drilling is required. However, the top and bottom flanges must not be notched. Avoid damaging the outside diameter of the pipe as you cable through the metal cross web members.



TIMBER FRAMED CONSTRUCTION

Speedfit is well suited for timber frame construction. Ensure that the structural integrity is not compromised when installing the pipework.

If the pipe passes through an external wall, care must be taken not to damage the vapour barrier and should be installed on the inside of the thermal insulation layer.

If this is not possible, the use of conduit should be specified at the design stage.

STEEL FRAMED CONSTRUCTION

Speedfit is well suited for steel frame construction and care should be taken when installing the pipework.

All runs should be installed through preformed holes in the structure and protected by a rubber or plastic grommet.

Where clipping of pipework is restricted, cable ties may be used to secure the pipe.

As with all installations, make sure that any pipework passing through walls and floors does not affect the fire resistant properties of the structure.

DRY LINED WALLS

Speedfit pipework can be easily cabled through studwork and within wall systems as well as behind “dot and dab” plasterboard installations. Speedfit 10mm Barrier Pipe is most commonly used to feed radiators.

If incorporating fittings in this way, collet covers or collet clips must be used with the **Standard** range of fittings.

WET PLASTER

To prevent surface damage to the plaster caused by expansion and contraction of Speedfit pipes, it is important to ensure that all Speedfit pipework is channelled into the wall and protected with appropriate sleeving. Alternatively, the pipework can be surface mounted and boxed in if required for aesthetic appearance.

LAYING OF PIPE IN CONCRETE AND MASONRY

Speedfit pipe and fittings can be laid in concrete and masonry providing they are installed in conduit pipe with access boxes for the fittings. As stated in Water Regulation Schedule 2.7 and BS 8000 : Part 15, fittings and pipe should be removable for possible replacement. Insulation is also recommended to protect against heat loss and the effects of frost.



Speedfit Conduit Pipe is supplied in either 15mm or 22mm in coil lengths of 25m or 50m. The flexible convoluted pipe has an outside diameter of 24mm and 30mm.

EXPOSED PIPEWORK

On long exposed runs of pipework, the expansion of Speedfit pipe when warm (1% on length between 20 to 82°C) can cause it to sag between clip fixings. When this is undesirable, pipework can be boxed in or replaced with rigid copper pipe.

Speedfit pipe and fittings are stabilised to withstand limited exposure to ultra-violet radiation in sunlight but are not designed for permanent direct exposure. Under such conditions painting or lagging is required. Pipe and fittings should also be lagged to prevent frost damage.

CHEMICAL EFFECTS

Only water or oil based paints should be used. Do not allow Speedfit fittings to come into contact with cellulose based paints, paint thinners or strippers, solder flux or acid based descalents or aggressive cleaning products. If there is a risk of any chemical treatments coming into contact with Speedfit, please contact the Technical Advisory Service first to check compatibility.

FLUXES AND SPEEDFIT

JG Speedfit does not recommend that fluxes of any type come into contact with our pipe and fittings. However, if fluxes are to be used in an environment where Speedfit is installed then we recommend installers use non-acidic and zinc chloride free fluxes such as Fernox Flux.

ACOUSTIC

Properly installed, Speedfit pipes are virtually silent in operation and do not resonate; they absorb the acoustic vibrations and pressure waves created by cavitations, water hammer, float operated valve oscillation and other hydraulic effects. The inherent flexibility of Speedfit pipe effectively eliminates these troublesome problems, including those that occur when, due to thermal expansion, metal pipes rub against structural members and where long, straight runs of rigid pipe amplify water borne noise.

PROTECTION AGAINST RODENTS

When used in locations vulnerable to rodent attack, all plastic pipes and fittings should be adequately protected within sealed ducts.

Speedfit products along with other materials such as electrical cables may be damaged if rodents are present. If vermin infestation is suspected then a rodent exterminator should take appropriate action.

BIOLOGICAL

No taste, colour, odour or toxicity is imparted to water by Speedfit components, nor do they promote microbiological growth.

In accordance with BS7291: Part 1 Clause 6.7, the opacity of both pipes and fittings allows insufficient light to pass for the growth of algae.

Tests within the Water Regulations Advisory Scheme, have approved Speedfit pipe and fittings to BS 6920 for water quality.

SYSTEM TESTING

On completion of the plumbing and heating system it is essential that system checking and a hydraulic wet test takes place. Connections to boilers, radiators and sanitary ware should first be capped or plugged.

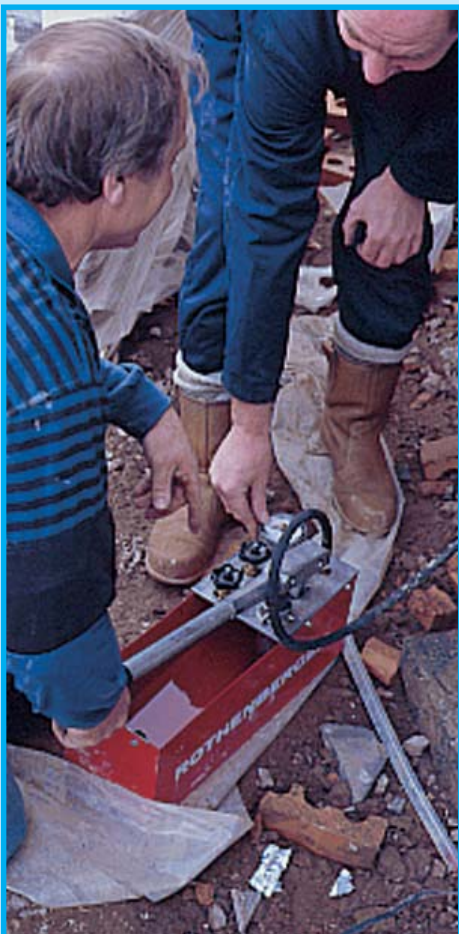

Testing Should be carried out at 2 bar for 10 minutes followed by 10 bar for 10 minutes.

This testing combined with other relevant checks, should reveal most system problems. Any components within the system not designed to take these pressures should be disconnected.

Before carrying out a pressure test ensure all Speedfit pipe and fittings are installed correctly. Speedfit Barrier Pipe is printed with insertion marks to help ensure full insertion has been achieved.

Remember pressure testing is NOT a substitute for making sure fittings are clean and free of any grit, dirt or swarf and the pipe is correctly inserted (see Making a Good Connection).

SYSTEM COMMISSIONING AND FLUSHING

With existing systems, flushing prior to the use of Speedfit is essential to remove any harmful contamination or chemical residues from elsewhere in the system.

For the installation of central heating systems flushing procedures must be in line with BS7593 code of practice for treatment of water in domestic hot water heating systems.

Flux residues used in the soldering of capillary fittings are very corrosive. Dirt and grit, which can enter the system when Speedfit pipe is being pushed through underfloor or across a roof space, must be removed.

During the commissioning of a heating system, all air must be removed from the system before the boiler is allowed to fire. This will ensure pockets of air do not cause localized overheating within the system as this could have a detrimental affect on the pipework and boiler.

For further advice on chemical flushing agents and inhibitor treatments, the following manufacturers should be contacted: Fernox Manufacturing Ltd., 01799 550811 or Sentinel Betz Dearborn Ltd., 0151 420 9595.

TECHNICAL ADVISORY SERVICE

The JG Speedfit Technical Advisory Service is available to assist and advise on all aspects of using the Speedfit system. The service is available between 8.00am and 4.30pm, Monday to Friday on Telephone No. 01895 425333 and Fax No. 01895 425350. Products within this Product Guide are designed for use within UK plumbing and heating installations or in other countries where similar installation requirements apply. For information on products suitable for use in other countries please consult our Technical Advisory Service.

We take pride in the quality of our products and all complaints are investigated thoroughly. If you have a problem with a Speedfit Product please return both fitting and pipe to us for investigation. We will need at least 50mm of pipe to ensure an accurate analysis. If there is a suspicion that the pipe is faulty, please provide marking details from the pipe.

UNDERFLOOR HEATING

The Speedfit Underfloor Heating System has been designed to require the minimum of installation effort, with components designed and manufactured to ISO 9001 and DIN 4726.

CONTROL UNIT



PART No.	DESCRIPTION	PACK QTY
JGROOMPACK	SINGLE ROOM CONTROL UNIT	1

For conservatories or room extensions up to 30m².

SINGLE ROOM UNDERFLOOR HEATING PACK



PART No.	DESCRIPTION	PACK QTY
JGROOMPACK20	UNDERFLOOR HEATING PACK	1

For conservatories or room extensions up to 20m².

Pack contains: 1 x 15mm x 150m Coil Polybutylene Pipe
1 x Single Room Control Unit
1 x Programmable Room Thermostat
200 x 15mm Pipe Clips
2 x 15mm Pipe Inserts

MANIFOLDS

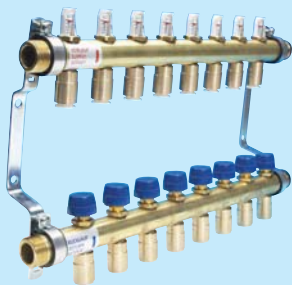

PART No.	DESCRIPTION	PACK QTY
JGUFHMAN4	4 ZONE MANIFOLD	1
JGUFHMAN8	8 ZONE MANIFOLD	1
JGUFHMAN12	12 ZONE MANIFOLD	1

Supplied with pipe inserts and collet clips.

MANIFOLD EXTENSION KIT



PART No.	DESCRIPTION	PACK QTY
JGUFHMANEXT	MANIFOLD EXTENSION KIT	1

Enables a manifold to be extended by one or more zones.

PUMP PACK



PART No.	DESCRIPTION	PACK QTY
JGPUMPPACK	PUMP PACK	1

Manufactured in DZR brass, the pack consists of a pump, mixing valve and overheat temperature thermostat.

ACTUATOR VALVES



PART No.	DESCRIPTION	PACK QTY
JGUFHA(240 v)	240 v CIRCUIT ACTUATOR VALVE	1

WIRING CENTRE

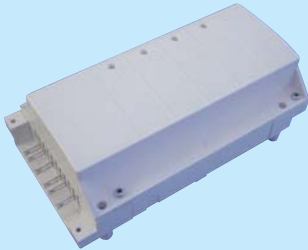

PART No.	DESCRIPTION	PACK QTY
JGUFH4ZM	MASTER WIRING CENTRE 4 ZONE	1
JGUFH4ZS	WIRING CENTRE SLAVE 4 ZONE	1
JGUFH6ZS	WIRING CENTRE SLAVE 6 ZONE	1

Wiring Centre Slaves connect to Master Wiring Centres to give an additional 4 or 6 zones.

ROOM THERMOSTAT



PART No.	DESCRIPTION	PACK QTY
JGUFHTH	ROOM THERMOSTAT WITH OVERNIGHT TEMPERATURE REDUCTION MODE	1
JGUFHTHKIT	WET AREA PROBE + COVER	1

The Room Thermostat with Set Back works in conjunction with a Centralised System Timer.

SYSTEM TIMER



PART No.	DESCRIPTION	PACK QTY
JGUFHTIMER - C	CENTRALISED SYSTEM TIMER	1
JGUFHTIMER - R	REMOTE SYSTEM TIMER	1

Centralised System Timers are used with a Set Back Thermostat. Remote System Timers are used as a Set Back Thermostat or as a conventional 4 channel programmer.

PROGRAMMABLE ROOM THERMOSTAT



PART No.	DESCRIPTION	PACK QTY
JGUFHPRS	PROGRAMMABLE ROOM THERMOSTAT	1

NOT for use with set back timer.

PEX BARRIER PIPE



PART No.	DESCRIPTION	SIZE	PACK QTY
15BPEX-50C	BARRIER PIPE	15MM X 50M	1
15BPEX-100C	BARRIER PIPE	15MM X 100M	1
15BPEX-120C	BARRIER PIPE	15MM X 120M	1
15BPEX-150C	BARRIER PIPE	15MM X 150M	1

POLYBUTYLENE BARRIER PIPE



PART No.	DESCRIPTION	SIZE	PACK QTY
15BPB-50C	BARRIER PIPE	15MM X 50M	1
15BPB-100C	BARRIER PIPE	15MM X 100M	1
15BPB-120C	BARRIER PIPE	15MM X 120M	1
15BPB-150C	BARRIER PIPE	15MM X 150M	1

SPREADER PLATES

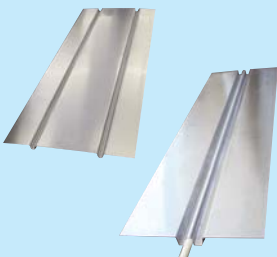

PART No.	DESCRIPTION	PACK QTY
JGUFHSP400	390mm x 1000mm	10
JGUFHSP250	165mm x 250mm	10
JGUFHSP165	For I Beam Joists	20

Spreader Plates 390 x 1000mm and 390 x 250mm are laid across traditional joists.

Spreader Plates 165 x 1000mm are fixed to the underside of flooring between traditional or TJI Joists.

EDGE INSULATION STRIP



PART No.	DESCRIPTION	PACK QTY
JGUFHEDGE	25 METRE ROLL	1

Supplied in 25 metre rolls, the edge insulation strip is placed round the edge of each room to provide insulation of the heated floor.

PIPE FIXING SYSTEMS

Speedfit offer several ways of securing pipe to the insulation layer in a screeded floor.

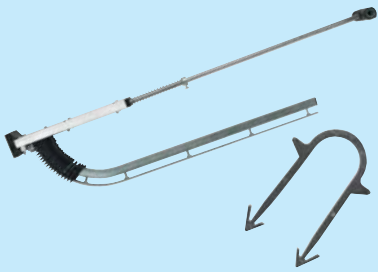

PART No.	DESCRIPTION	SIZE	PACK QTY
JGUFHSTAPLE	PIPE STAPLES	60mm	300
JGUFHGUN	STAPLE GUN	-	1

Black Staples are barbed to ensure a secure fixing to the insulation. Easy fixing is carried out by using a Staple Gun, securing pipe to the insulation with an easy repeatable action.

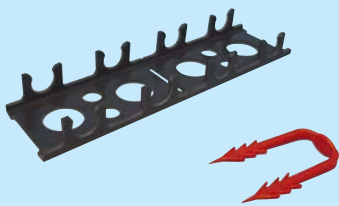

PART No.	DESCRIPTION	PACK QTY
JGUFHRAIL	2 METRE LONG	16
JGUFHPIN	RAIL PINS FOR ABOVE	100

Mounting Rails offer a quick installation of 15mm pipe. Supplied 2 metres long, the rails are pre scored every 100mm for easy cutting. The rail can be secured to the insulation using red Rail Pins.



PART No.	DESCRIPTION	PACK QTY
JGUFHCLIP	FLOOR CLIP	100
JGUFHTOOL	FOR EASY FIXING OF FLOOR CLIPS	1

Floor Clips screw easily into insulation, they are best installed using a Fixing Tool.

UNDERFLOOR HEATING SPARE PARTS

PART No.	DESCRIPTION	PACK QTY
SPUFH1	MIXING VALVE CARTRIDGE KIT	1
SPUFH2	PUMP PACK FLOW TEMP GAUGE	1
SPUFH3	OVER HEAT STAT	1
SPUFH4	MANIFOLD FLOWMETER	1
SPUFH5	MANIFOLD BALANCING VALVE	1
SPUFH6	DUST CAP FOR BALANCING VALVE	1



Full technical and installation advice on the Speedfit Underfloor Heating System is shown in our new Underfloor Heating Manual.

UNDERGROUND FITTINGS

APPLICATIONS

Speedfit underground fittings for metric size polyethylene cold water service pipe have been designed for connection of:

- 1. Blue MDPE pipes to BS 6572** - used for underground service pipes for potable water.
- 2. Black MDPE pipes to BS6730** - used for conveyance of potable water above ground or for industrial services above or below ground.
- 3. Pipe to ISO 161/1, ISO 3607 and DIN 16893.**

Making the connection could not be easier. All you need is the pipe, the fitting and a pair of hands. The range is designed to provide a long service life and includes adaptors for screwed pipe, copper and imperial sized LDPE.

INSTALLATION BENEFITS

- Easy to use in confined spaces, no tools required.
- Fast installation with resulting cost savings.
- Lightweight and slimline.
- Ready for immediate installation, no dismantling.
- No adjustments required after fitting.
- Adaptors for screwed pipe, copper and imperial LDPE.

PERFORMANCE BENEFITS

- Maintenance free.
- Durable with high resistance to impact.
- Patented collet ensures high resistance to pull out.
- Lead free and non toxic.
- Will not support biological growth.
- A reliable and trouble free leakproof connection.

MAKING A GOOD CONNECTION

Cut pipe square using pipe cutters remove burrs and sharp edges. Always use a pipe insert.

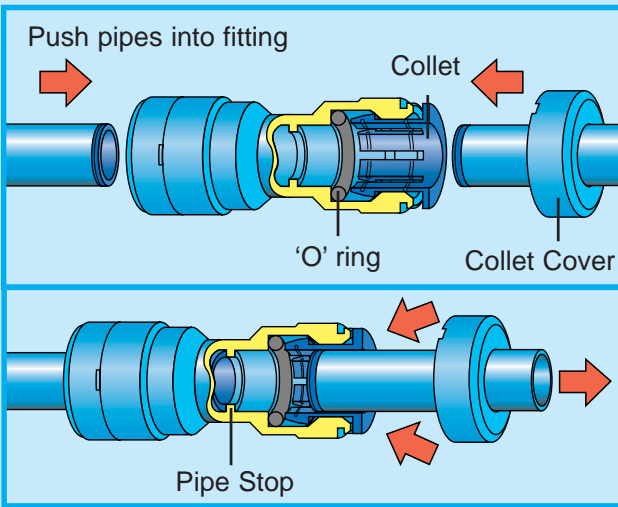
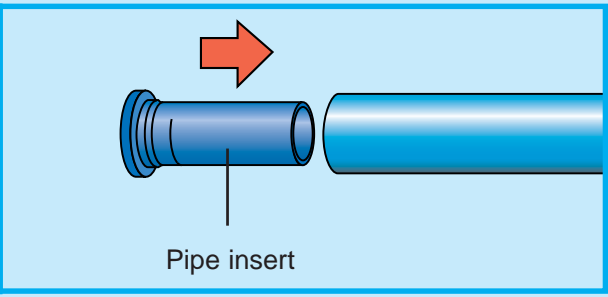
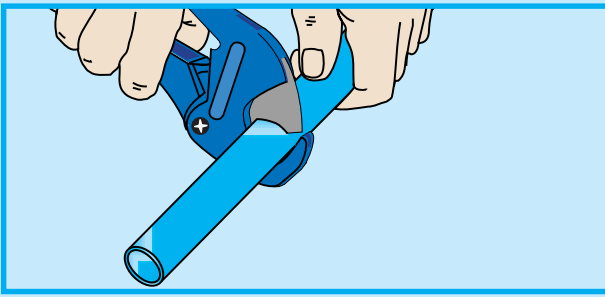

The fitting is supplied ready for installation and requires no adjustment. Push the pipe into the fitting.

Push the pipe up to the pipe stop, a distance of approximately 50mm. The collet has teeth that grip the pipe whilst the 'O' ring provides a permanent leak proof seal.

TO DISCONNECT

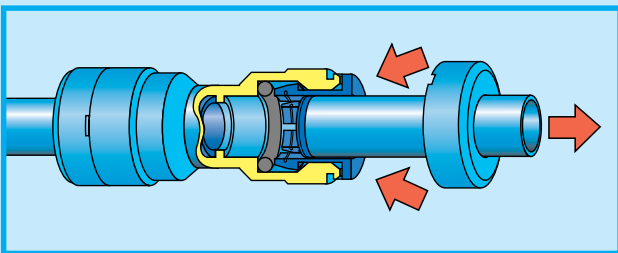

Ensure that the system is depressurised. Release and pull back collet cover. Push in collet square against the face of fitting.

With the collet held in this position, the pipe can be withdrawn.

We recommend the replacement of the 'O' ring and collet before making a new connection.

CONNECTING TO IMPERIAL SIZE LDPE

Using the Inch Change Kit shown on page 56.

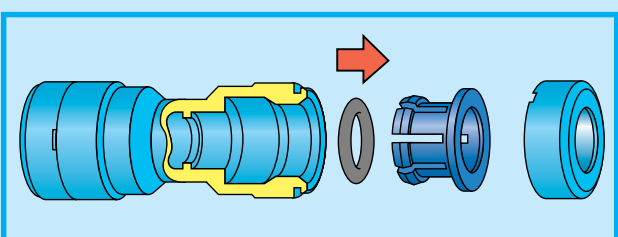

Remove collet cover, pull out metric size collet and 'O' ring. Keep with metric pipe support liner for future use.

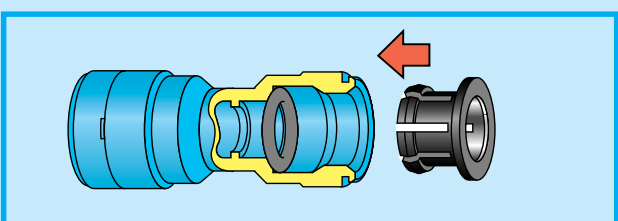

Carefully push imperial size 'O' ring and collet into position, ensuring seal is clean before insertion.

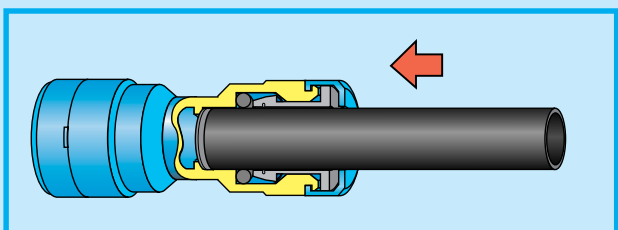

Replace the snap-fit collet cover and, having inserted the imperial pipe support, connect the pipe as shown above.

PRODUCT RANGE

EQUAL STRAIGHT CONNECTOR



PART No.	SIZE MM	Box QTY
JG401B	20	20
JG402B	25	20

Cold water only

REDUCING STRAIGHT CONNECTOR



PART No.	SIZE MM	Box QTY
JG501B	25 x 20	20

Cold water only

MALE ADAPTOR



PART No.	SIZE MM X BSP	Box QTY
JG101B	20 x 1/2"	30
JG102B	25 x 3/4"	30

Cold water only

FEMALE ADAPTOR



PART No.	SIZE MM X BSP	Box QTY
JG4501B	20 x 1/2"	30
JG4502B	25 x 3/4"	30

Cold water only

PLUGS



PART No.	SIZE MM	Box QTY
JG801E	20	100
JG802E	25	50

Cold water only

EQUAL ELBOW



PART No.	SIZE MM	Box QTY
JG301B	20	10
JG302B	25	10

Cold water only

STEM ELBOW



PART No.	PIPE OD	STEM OD	Box QTY
JG222025B	20mm	25mm	20

Cold water only

EQUAL TEE



PART No.	SIZE MM	Box QTY
JG201B	20	10
JG202B	25	10

Cold water only

PE-COPPER COUPLER



Used to connect PE Pipe to copper or Speedfit Plumbing Pipe

PART No.	SIZE MM	Box QTY
JG601B	20 x 15	20
JG603B	25 x 15	20
JG602B	25 x 22	20

Cold water only
Suitable for Tables X & Y Copper

PIPE INSERT



PART No.	SIZE MM	Box QTY
UTS147 - DB	20	200
UTS197 - DB	25	200

INCH CHANGE KIT



To convert metric size fittings for use with imperial size LDPE to BS1972 Class C or Class D

PART No.	SIZE MM	Box QTY
JGK01E	1/2"	320
JGK02E	3/4"	320

Cold water only

SPARE PARTS

COLLETS



PART No.	SIZE MM	PACK QTY
20 UPC	20	10
25 UPC	25	10

'O' RING



PART No.	SIZE MM	PACK QTY
20 UOR	20	10
25 UOR	25	10

COMMON PROBLEMS AND IDENTIFICATION

Problem : Burst or melted pipe.

Pipe will be distorted showing either a 'Parrot beak' look or a long opening with the edges of the pipe melted in a wave shape.

Identification : A 'Parrot beak' will have been formed by the pipe bursting due to the water freezing. If the BPEX Pipe has a melted appearance it will have been subject to a temperature in excess of 128 degrees Celsius. This will have been caused by direct contact with a heat source such as a blowtorch or flue pipe or by water or steam within the system rising above safety levels.

Problem : A fitting or part of a fitting dissolved - the fitting may have blown off the pipe and may have missing component parts.

Identification : The fitting will have failed because of a chemical attack. The most common attack is from acid based solder flux running down into the fitting during soldering of a nearby copper fitting or flux coming into contact with the fitting in some other way.

Problem : Weep from fitting.

Identification : The pipe has not been fully inserted up to the pipe stop or one or both of the 'O' rings have been damaged by burrs or sharp edges on the end of pipe. See 'What Not to Do' on page 08.

Problem : The fitting has blown off the pipe. Fitting is missing the collet, the pipe insert is still inside the fitting after the pipe has come out.

Identification : If this happens on first fix, the most likely reason is that the pipe has not been fully inserted into the fitting, up to the pipe stop, and the system has not been pressure tested.

If the collet (gripping device) is missing everything will blow out. If the collet is there and the pipe support is still inside the connector but the pipe has still blown out, this means that full insertion had not been accomplished.

TECHNICAL CHECKLIST - PLUMBING AND HEATING FITTINGS

Fittings and pipe should be kept clean and undamaged before use.

- **Sizes.** 10mm to 28mm diameter.
- **Pipes.** Speedfit fittings can be used with:
Copper pipe to BS EN 1057
Speedfit Barrier Pipe to BS7291.

Speedfit fittings cannot be used on stainless steel pipe.

- **Standards.** Speedfit products are designed and manufactured under a fully integrated system assessed by B.S.I. to BS EN ISO9001. They are approved by the WRAS and BBA. Speedfit PEM and PKM Fittings and Speedfit Barrier Pipe are Kitemarked to BS7291 Parts 1, 2 and 3, Class S. (Licence No. KM39767)
- **Applications.**
Mains fed and indirect cold water systems
Vented and unvented hot water systems
Vented and sealed central heating systems
- **Do not use for Gas, fuel oil or compressed air applications.**
- **Working temperatures and pressures**

<i>Application</i>	<i>Usual working temperature, °C</i>	<i>Maximum working temperature, °C</i>	<i>Maximum working pressure, bar</i>
Cold Water (indirect and direct mains)	20	20	12
Central Heating	82	105, short term malfunction at 114	3
Hot Water (including unvented cylinders)	65	95	6

- **Burst Pressure (fittings).** With copper or plastic pipe at 20°C: Speedfit fittings used with copper or Speedfit (PEX) barrier pipe will withstand pressures well in excess of normal service conditions.
- **High temperatures.** Can withstand 114°C intermittently for short periods. The Speedfit system should not be used on an uncontrolled heat source.
- **Insulation.** Should comply with BS6700 and BS5422, as for copper.
- **Minimum bend radii (PEX)**

<i>Pipe diameter</i>	10mm	15mm	22mm	28mm
<i>Min radius with clips</i>	100mm	175mm	225mm	300mm
<i>Min radius with cold forming bend</i>	30mm	75mm	110mm	-

- **Clip spacing (in mm).** For surface mounted pipes

<i>Pipe Diameter</i>	<i>Clip Spacing</i>	
	<i>Horizontal Run</i>	<i>Vertical Run</i>
10 - 15mm	300mm	500mm
22mm	500mm	800mm
28mm	800mm	1,000mm

- **Expansion (PEX pipe).** 1% on length between 20°C and 82°C.
- **Flow rates.** Comparable with metal systems.
- **Cleaners, inhibitors and descalents.** For advice on the replenishment of additives such as corrosion inhibitors, the following manufacturers should be contacted: Fernox Manufacturing Limited on 01799 550811 or Sentinel, BetzDearborn Limited on 0151 420 9595.
- **Paint and Chemicals.** Use only water or oil based paint. Collet covers prevent paint ingress into fittings. **DO NOT ALLOW CONTACT WITH** oil based jointing compounds, cellulose based paints, paint thinners or strippers, solder flux or acid based descalents or aggressive cleaning products.
- **Exposure to sunlight.** Speedfit products, when used indoors, are not affected by sunlight. When used outdoors protect from ultra violet light by lagging or painting.

- **Solder Flux.** No fluxes of any types should come into contact with JG Speedfit Pipe and Fittings. If fluxes are to be used in an environment where Speedfit is installed, then (1) extreme care should be taken to ensure that no such contact takes place and (2) JG recommend installers only use fluxes tested and approved in writing in advance by JG. At the date of this publication, the only such approved flux is Fernox Flux.
- **Chlorine.** Speedfit is not suitable for use in systems where the water contains high levels of chlorine. e.g. swimming pools, fountains etc.
- **Pipe clips.** Pipe clips should not be fitted any closer than 60mm from the end of the fitting. Pipe should be adequately supported by pipe clips to prevent undue stress (side load) on fittings.
- **Pipe inserts.** Must be used on all installations when using plastic pipe and should be fully inserted.
- **Metal Joists.** When ‘cabling’ plastic pipe through metal joists ensure rubber grommets are in place to prevent damage to pipe. Use of collet covers or collet clips on fittings recommended.
- **Connection to boilers.** A minimum 1000mm run of copper pipe must be installed between the boiler and the Speedfit system, as per BS5955: Part 8.
- **Connection to copper pipe.** 450mm is the minimum distance to make a solder connection on copper pipe inserted into a Speedfit Fitting. Ensure that any residual flux solder does not come into contact with the fitting.
- **Concrete and masonry.** Speedfit pipe and fittings can be laid in concrete and masonry providing they are installed in conduit pipe with access boxes for the fittings. This is to enable the pipe to expand and provide accessibility for both pipe and fittings. As stated in Water Regulation Scheme 2.7 and BS 8000 : Part 15, fittings and pipe should be removable for possible replacement. Insulation is also recommended to protect against heat loss and the effects of frost.
- **Electrical continuity.** If Speedfit is used in an existing metal system which may have been used for earthing, electrical continuity should be reinstated.
- **Valves and taps.** Plastic 15mm and 22mm valves and taps available from JG Speedfit Ltd are not suitable for central heating installations.
- **Collet Covers.** Collet covers provide added security for standard fittings against pipe disconnection, e.g. the fittings coming into contact with rigid surfaces and behind dry-lining walls. They are offered in white as standard and in red or blue to provide colour coding of pipe.
- **Collet Clips.** White or grey collet clips are used with standard fittings to prevent accidental pipe disconnection. Red or blue clips provide colour coding of pipe. Red and blue clips should not be used to prevent accidental release of pipe.
- **System testing.** To ensure the pipework and fittings have been installed correctly, whether it be on a new or extended system, it is essential that the system is checked and hydraulically wet tested. Testing should be at 2 bar for 10 minutes and 10 bar for 10 minutes. This testing, combined with other relevant checks, should reveal installation problems and is regarded as good plumbing practice. However, system testing should not be regarded as a substitute for correct installation (see also “Making a Good Connection”).
- **System flushing.** As is usual practice for any plumbing installation, flushing of the system prior to the use of Speedfit is recommended to remove any contaminants/chemical residue from elsewhere in the system.
- **British Gas Service has accepted the John Guest Speedfit fittings as being suitable for open vented and sealed central heating systems and as eligible for acceptance onto its service contracts.**
- **Vermin.** Speedfit products will need special protection in vermin infested areas.
- **Maximum Torque figures.** The maximum torque figures for BSP and BSPT threads used on Speedfit plumbing products in mating threads conforming to the relevant British or International thread standards.

<i>Threads Size</i>	<i>Maximum Torque</i>
<i>Plastic 1/2"</i>	3.0 Nm
<i>3/4"</i>	4.0 Nm
<i>Brass 1/2"</i>	4.0 Nm
<i>3/4"</i>	5.0 Nm

It is recommended that all installations are checked prior to use to determine that seal has been made.

TECHNICAL CHECKLIST

- UNDERGROUND FITTINGS

- **Applications.** Speedfit Underground Fittings are designed to connect MDPE pipes (MRS-PE80) used above or below ground, to convey potable water from distribution mains to individual properties.
- **Sizes.** 20mm and 25mm with adaptors for:-
 - Copper to BS2871 Part 1 / BS EN1057. Table X and Table Y.
 - Screwed pipe.
 - LDPE (to BS1972 Class C and Class D) in 1/2" and 3/4" inch sizes.
- **Pipes.** Speedfit Underground Fittings can be used with:-
 - Blue MDPE pipe to BS6572.
 - Black MDPE pipe to BS6730.
 - Pipes conforming to ISO161/1, ISO3607 and DIN16893.
- **Working Temperatures and Pressures.** Maximum working pressure 12 Bar @ 20°C.
- **Standards.** Speedfit Underground Fittings are approved by the Water Regulations Advisory Scheme.
- **Performance.** The fittings are manufactured from tough plastic material well able to meet the stringent requirements of the water industry. They have been approved by the WRAS and, as such, have passed the 'pull out test' where a force shown below is applied to a connection between MDPE pipes and a fitting for 5 minutes without the connection failing.

	Size	
Test Force	20mm	25mm
Newtons	1900	2500
lbs	427	562

- **DO NOT USE FOR Gas, fuel oil or compressed air applications or hot water.**
- **Chemical Effects.** For below ground applications the fittings require no additional preparations - coating etc. When used above ground, avoid contact with aggressive chemical compounds. Protect from frost where necessary. In the United Kingdom, potable water does not contain high levels of chemicals (eg chlorine etc) that would adversely affect Speedfit Underground Fittings.
- **Exposure to sunlight.** Permanent exposure to direct sunlight will necessitate lagging the fittings.
- **Pipe Inserts.** Pipe inserts must be used and fully inserted on all connections to MDPE or LDPE pipe.
- **System Testing.** Pressure test to 1.5 times working pressure for 10 minutes before connecting to the mains supply. It is recommended that all pipe and fitting installations are pressure tested after installation before handing over to the final user
- **Maximum Torque Figures.** The maximum torque figures for BSP and BSPT threads used on Speedfit products are as follows:-

Size	Maximum Torque
1/2	3.0 Nm
3/4	4.0 Nm

It is recommended that all installations are checked prior to use to determine that a seal has been made.

The maximum torque figures quoted for use with Speedfit fittings are dependent on the mating thread conforming to the relevant British International thread standards.